

Nuclear imaging

Positron Emission Tomography (PET),
Single-Photon Emission Computed Tomography (SPECT)

André Sopczak

Institute of Experimental and Applied Physics,
Czech Technical University in Prague
<http://cern.ch/sopczak>
andre.sopczak@cvut.cz
based on lectures 2005-2022 by Jan Kybic,
Department of Cybernetics, FEE CTU

2023

Resources

- ▶ <http://www.bic.mni.mcgill.ca/~louis/seminars/399-650/pet.html>
- ▶ http://ocw.mit.edu/NR/rdonlyres/Nuclear-Engineering/22-01Introduction-to-Ionizing-RadiationFall2003/60AA5867-88AE-49C7-9478-2F4661B4EBBE/0/pet_spect.pdf
- ▶ <http://www.pet.mc.duke.edu/rsna04/turk-petspectphysicsRSNA2005.pdf>
- ▶ <http://www.nuclear.kth.se/courses/medphys/5A1414/TOFPET1.pdf>
- ▶ <http://www.fmri.org>,
- ▶ A. Webb: Introduction to Biomedical Imaging
- ▶ images by: Wikipedia, NIH, Moazemi et al., Rager et al., Virginia Commonwealth University...

Principles of nuclear imaging

Radioactivity

Gamma camera

SPECT

PET

Conclusions

Nuclear versus X-ray imaging

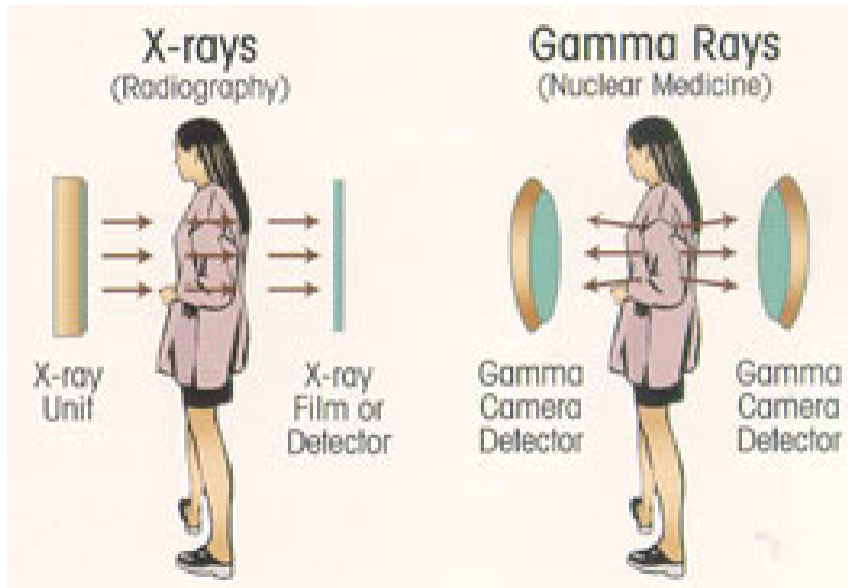

Nuclear versus X-ray imaging (2)

- ▶ **X-ray and CT**

- ▶ *transmission* imaging, external source

- ▶ **PET, SPECT**

- ▶ *emission* imaging, source internal to body

Nuclear versus X-ray imaging (2)

- ▶ **X-ray and CT**

- ▶ *transmission* imaging, external source
- ▶ **Anatomic imaging (shape, fracture)**

- ▶ **PET, SPECT**

- ▶ *emission* imaging, source internal to body
- ▶ **Functional imaging (metabolism, perfusion), tracer concentration**

Nuclear versus X-ray imaging (2)

- ▶ **X-ray and CT**

- ▶ *transmission* imaging, external source
- ▶ Anatomic imaging (shape, fracture)
- ▶ X-rays

- ▶ **PET, SPECT**

- ▶ *emission* imaging, source internal to body
- ▶ Functional imaging (metabolism, perfusion), tracer concentration
- ▶ γ rays

Nuclear versus X-ray imaging (2)

▶ X-ray and CT

- ▶ *transmission* imaging, external source
- ▶ Anatomic imaging (shape, fracture)
- ▶ X-rays
- ▶ Good resolution, < 1 mm

▶ PET, SPECT

- ▶ *emission* imaging, source internal to body
- ▶ Functional imaging (metabolism, perfusion), tracer concentration
- ▶ γ rays
- ▶ Lower resolution, $5 \sim 20$ mm

Nuclear imaging applications

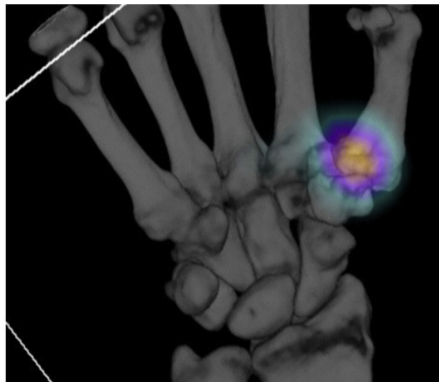
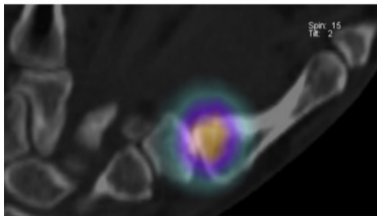

Hand, osteoarthritis, CT+SPECT

Nuclear imaging applications

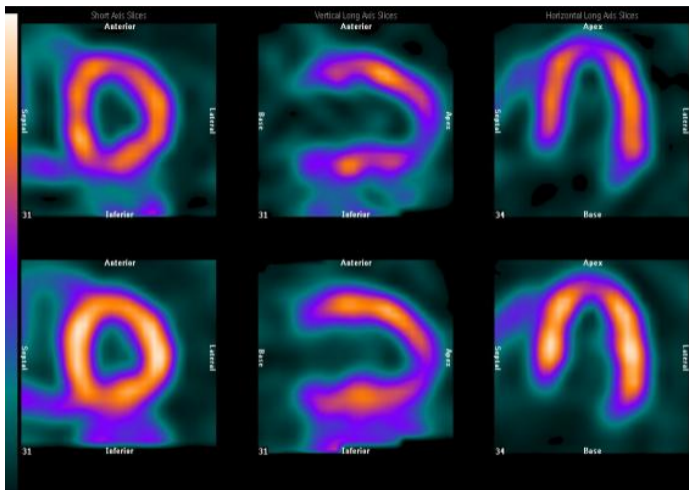

Heart, myocardial perfusion, PET

Nuclear imaging applications

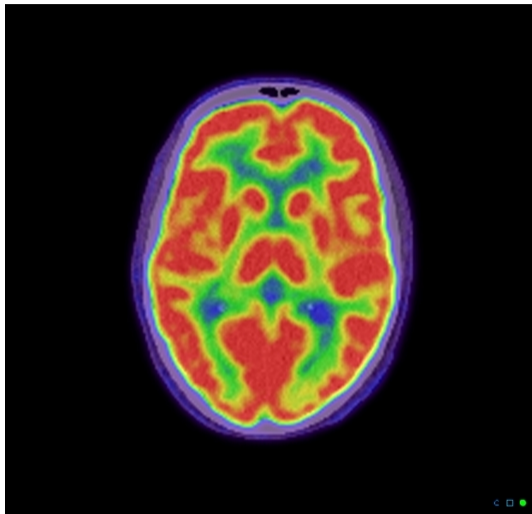

Brain, FDG PET, metabolism

Nuclear imaging applications

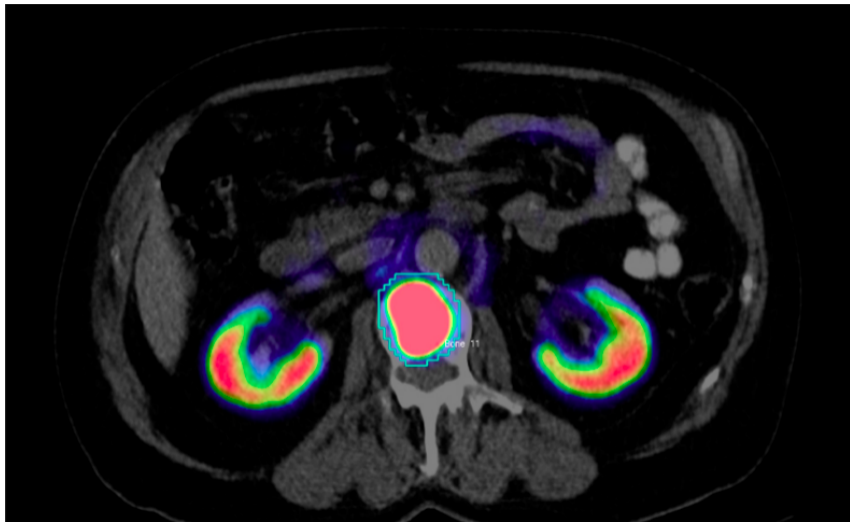

Renal (kidney) PET+CT, Ga-PSMA contrast agent.

Nuclear imaging applications



Metastases, SPECT+CT, MIP

Principles of nuclear imaging

Radioactivity

- Radioactive decay

- Radionuclide production

- Cyklotron

- Radiopharmaceuticals

Gamma camera

SPECT

PET

Conclusions

Radioactivity

- ▶ element = same number of protons
- ▶ isotope/nuclide = same number of protons and neutrons
- ▶ excess of neutrons/protons \rightarrow instability \rightarrow radioactive decay chain \rightarrow stable isotope

Valley of stability

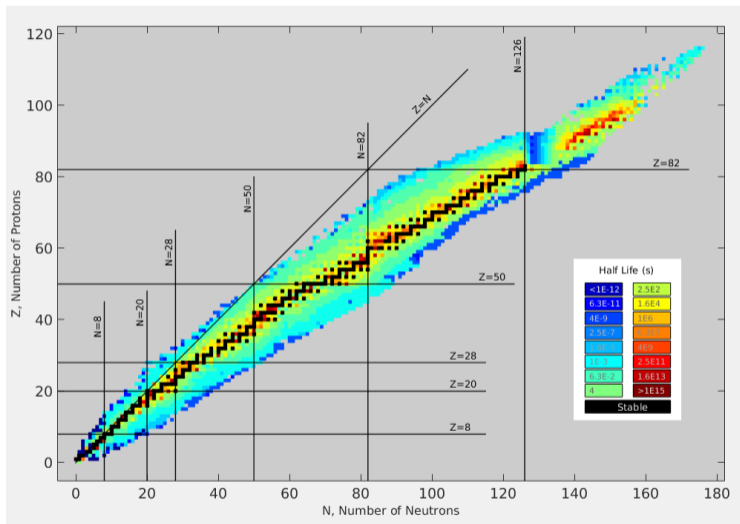

Isotopes with Z slightly smaller than N are stable.

Radioactive decay modes

Unstable parent nucleus \longrightarrow Daughter nucleus + particles (energy)

- ▶ Alpha decay (α)
- ▶ Beta decay (β)
- ▶ Positron decay (β^+)
- ▶ Isomeric transition
- ▶ Electron capture
- ▶ *Proton emission, neutron emission, . . .*

Alpha decay

- ▶ Spontaneous emission of α particles
 - ▶ 2 protons + 2 neutrons, ${}^4_2\text{He}$, charged
 - ▶ energy 4 ~ 8 MeV, speed $0.05c$
 - ▶ strong interaction, low penetration (cm in air, μm in tissue), easy shielding
 - ▶ important biological effects (relative biological effectiveness 20), DNA damage
 - ▶ no use in imaging, used in therapy
- ▶ happens in heavy nuclei and Be
- ▶ excess energy released as γ (electromagnetic) rays (photons)

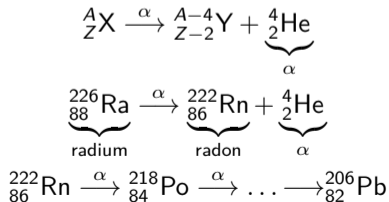

Decay chain

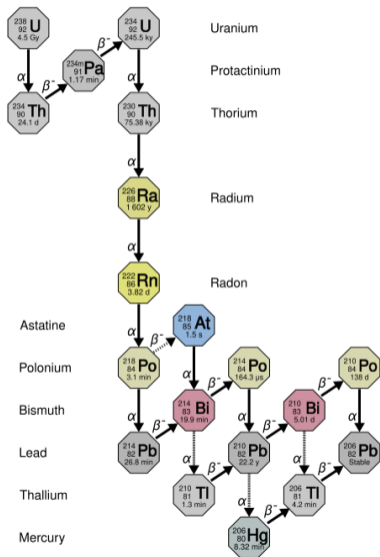

Beta decay

- ▶ β particles = electrons e^-
- ▶ Neutron conversion

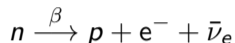

$\bar{\nu}_e$ — electron antineutrino

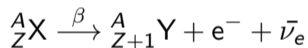

- ▶ For neutron-rich ($N > Z$) isotopes
- ▶ e^- ejected with high energy (β rays), continuous spectrum
- ▶ remaining energy = $\bar{\nu}_e$, nucleus recoil
- ▶ excited state nucleus $\longrightarrow \gamma$ rays

Beta decay

Examples

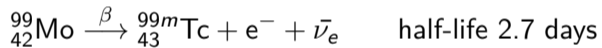
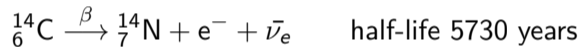

Isomeric transition

Excited state nucleus $\rightarrow \gamma$ rays

Metastable **Technetium** ${}_{43}^{99m}\text{Tc}$

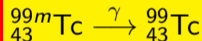
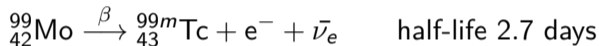
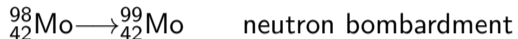

half-life 6 h

Isomeric transition

Excited state nucleus $\rightarrow \gamma$ rays

Metastable **Technetium** ${}_{43}^{99m}\text{Tc}$

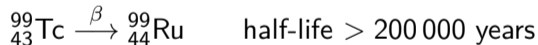
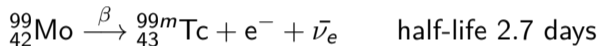
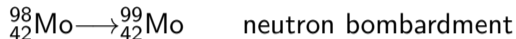

- ▶ most commonly used medical radioisotope
- ▶ γ (photon) energy 140 keV

Multiple decay processes

Iodine

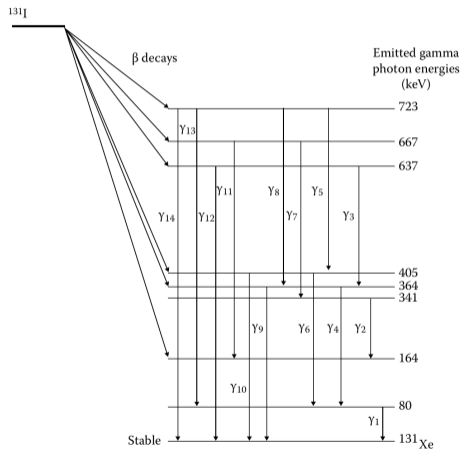

Positron decay

β^+ decay

- ▶ β^+ particles = positrons e^+
- ▶ Proton conversion

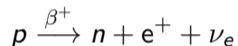

ν_e — electron neutrino

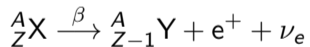

- ▶ For proton-rich ($N < Z$) isotopes

Positron decay

β^+ decay

Examples

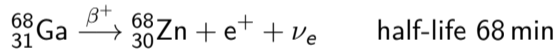
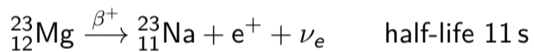

Positron decay

β^+ decay

- ▶ Positron e^+ is **annihilated**: $e^+ + e^- \rightarrow \gamma + \gamma$

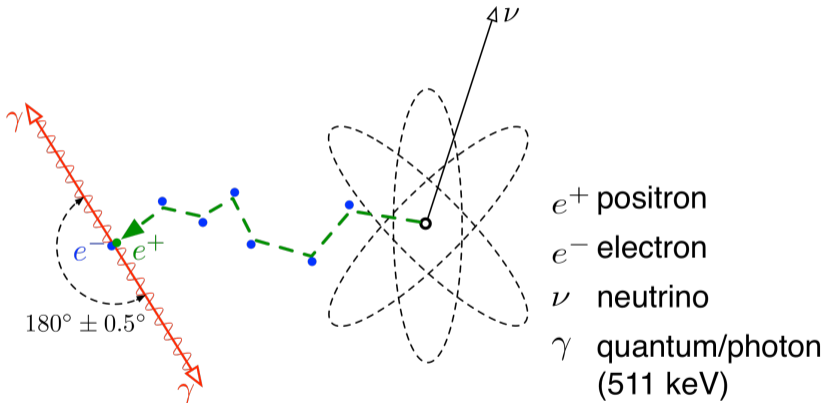

- ▶ **two photons** with energy 511 keV
- ▶ Parent/daughter nuclide energy difference $\gtrsim 1$ MeV

Electron capture

- ▶ Proton absorbs inner electron

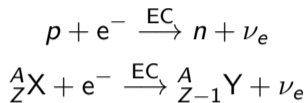

Example:

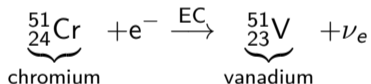

- ▶ Neutrino carries all energy (characteristic spectrum)
- ▶ Can occur for smaller energy differences
- ▶ Excited state nucleus $\rightarrow \gamma$ rays

Decay mode chart

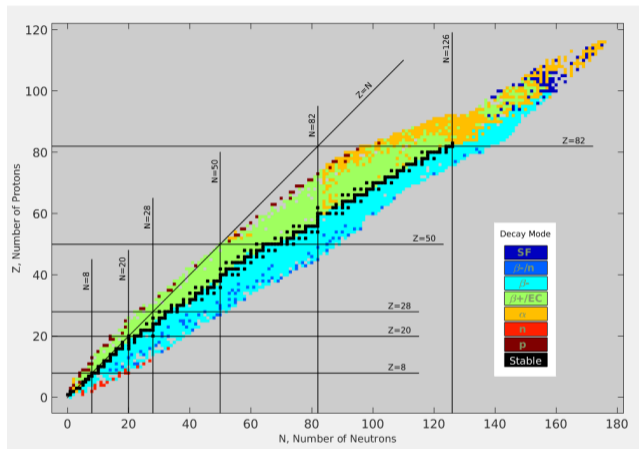

black: stable, light blue: β^- , green: β^+ or electron capture, orange: α , dark blue: fission, red: neutron emission, brown: proton emission

Nuclear imaging methods

▶ SPECT

- ▶ γ camera (2D)
- ▶ single photon emission computed tomography (3D)
- ▶ γ photon emitters

▶ PET

- ▶ positron emission tomography (3D)
- ▶ positron emitters

Ideal radionuclides for SPECT imaging

- ▶ Physical half-life long enough to allow preparation
- ▶ Physical half-life short enough to minimize long-term effects
- ▶ Pure γ emitter (isomeric transition, electron capture)
- ▶ Photon energy high-enough to penetrate tissue
- ▶ Photon energy low-enough for efficient shielding and detection

Single photon emitters

for SPECT nuclear imaging

Nuclide		Half-life	E_{photon} [keV]	
Technetium	${}^{99m}_{43}\text{Tc}$	6 h	140	most used
Iodine	${}^{123}_{53}\text{I}$	13 h	159	thyroid imaging
Indium	${}^{111}_{53}\text{In}$	2.8 d	171, 245	good, expensive
Thallium	${}^{201}_{81}\text{Tl}$	3 d	70 ~ 80	cardiac perfusion
Gallium	${}^{67}_{31}\text{Ga}$	3.25 d	90 ~ 400	tumor localization
Iodine	${}^{131}_{53}\text{I}$	8.1 d	364 ~ 606	radiotherapy

Positron emitters

for PET nuclear imaging

Nuclide	Half-life	
Rubidium $^{82}_{37}\text{Rb}$	1.3 min	cardiac imaging
Oxygen $^{15}_8\text{O}$	2 min	
Nitrogen $^{13}_7\text{N}$	10 min	
Carbon $^{11}_6\text{C}$	20.3 min	
Gallium $^{68}_{31}\text{Ga}$	68 min	tumor localization
Fluorine $^{18}_9\text{F}$	110 min	most often used, FDG
Copper $^{64}_{35}\text{Cu}$	12.7 h	oncology, radiotherapy

Mostly short half-time — need to be produced in-situ.

Activity

- ▶ Activity $A[\text{Bq}]$, $1 \text{ Bq} = 1 \text{ desintegration/s}$,
- ▶ Older unit $1 \text{ Ci} = 3.7 \cdot 10^{10} \text{ Bq}$ — 1 g of radium

Activity

- ▶ Activity A [Bq], $1 \text{ Bq} = 1 \text{ desintegration/s}$,
- ▶ Older unit $1 \text{ Ci} = 3.7 \cdot 10^{10} \text{ Bq}$ — 1 g of radium
- ▶ For N nuclei and a *decay constant* λ

$$A = \lambda N = -\frac{dN}{dt}$$

Exponential decay

- ▶ Exponential decay of N

$$N = N_0 e^{-\lambda t}$$

Exponential decay

- ▶ Exponential decay of N

$$N = N_0 e^{-\lambda t}$$

- ▶ Half-life

$$T_{1/2} = \log 2 / \lambda \approx 0.693 / \lambda \text{ [s]}$$

$$N = N_0 \left(\frac{1}{2} \right)^{\frac{t}{T_{1/2}}}$$

Exponential decay

- ▶ Exponential decay of N

$$N = N_0 e^{-\lambda t}$$

- ▶ Half-life

$$T_{1/2} = \log 2 / \lambda \approx 0.693 / \lambda \text{ [s]}$$

$$N = N_0 \left(\frac{1}{2} \right)^{\frac{t}{T_{1/2}}}$$

- ▶ Exponential decay of A

$$A = A_0 e^{-\lambda t}, \quad \text{with } A_0 = \lambda N_0, \quad A = \lambda N$$

Effective half-life

- ▶ Physical half-life T_p
- ▶ Biological half-life T_b
- ▶ Effective half-life T_e

$$\frac{1}{T_e} = \frac{1}{T_p} + \frac{1}{T_b}$$

Effective half-life

- ▶ Physical half-life T_p
- ▶ Biological half-life T_b
- ▶ Effective half-life T_e

$$\frac{1}{T_e} = \frac{1}{T_p} + \frac{1}{T_b}$$

Note: $T_e < T_p$, $T_e < T_b$

Effective Half-Life

E.g., for an isotope with a 6-hr half life attached to various carrier molecules with different biological half-lives.

T_P	T_B	T_E
6 hr	1 hr	0.86 hr
6 hr	6 hr	3 hr
6 hr	60 hr	5.5 hr
6 hr	600 hr	5.9 hr

Effective Half-Life

Assume 10^6 Bq localized in a tumor site, vary T

Nuclide	Half-life (T)	λ (sec ⁻¹)	N
1	6 sec	0.115	8.7×10^7
2	6 min	1.75×10^{-3}	5.7×10^9
3	6 hrs	3.2×10^{-5}	3.1×10^{11}
4	6 days	1.3×10^{-6}	7.7×10^{12}
5	6 years	4×10^{-9}	2.5×10^{15}

Effective Half-Life

Assume 10^{10} atoms of radionuclide localized in a tumor site, vary T

Nuclide	Half-life (T)	λ (sec⁻¹)	Activity (Bq)
1	6 sec	0.115	1.15×10^9
2	6 min	1.75×10^{-3}	1.7×10^7
3	6 hrs	3.2×10^{-5}	3.2×10^6
4	6 days	1.3×10^{-6}	1.3×10^4
5	6 years	4×10^{-9}	40

Principles of nuclear imaging

Radioactivity

Radioactive decay

Radionuclide production

Cyklotron

Radiopharmaceuticals

Gamma camera

SPECT

PET

Conclusions

Radionuclide production

- ▶ Neutron capture
- ▶ Nuclear fission
- ▶ Radionuclide generator
- ▶ (Positive) ion bombardment
 - ▶ Linear accelerator
 - ▶ Cyclotron

Neutron capture

Neutron activation/neutron bombardment

- ▶ Nuclear reactor, “thermal” neutrons, low energy $0.03 \sim 100$ eV
- ▶ Yield depends on neutron flow ϕ , cross section σ , decay constant λ , amount of carrier (source) material
- ▶ Chemical/physical purification

Neutron capture

Neutron activation/neutron bombardment

- ▶ Nuclear reactor, “thermal” neutrons, low energy 0.03 ~ 100 eV
- ▶ Yield depends on neutron flow ϕ , cross section σ , decay constant λ , amount of carrier (source) material
- ▶ Chemical/physical purification

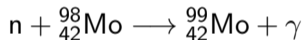

with proton emission

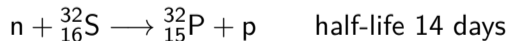

Radionuclides produced by neutron capture

Radionuclides produced by neutron absorption.

Radionuclide	Production Reaction	Gamma-Ray Energy (keV)	Half-Life	σ (Barn)
^{51}Cr	$^{50}\text{Cr}(n, \gamma)^{51}\text{Cr}$	320	27.7 days	15.8
^{59}Fe	$^{58}\text{Fe}(n, \gamma)^{59}\text{Fe}$	1099	44.5 days	1.28
^{99}Mo	$^{98}\text{Mo}(n, \gamma)^{99}\text{Mo}$	740	66.02 h	0.13
^{131}I	$^{130}\text{Te}(n, \gamma)^{131}\text{Te} \rightarrow ^{131}\text{I}$	364	8.04 days	0.29

Source: From Mughabghab et al., 1981.

Mostly used for radiotherapy (except $^{99}_{42}\text{Mo}$)

Nuclear fission

- ▶ Heavy nuclei ($A > 92$) — ${}_{92}^{235}\text{U}$, ${}_{92}^{237}\text{U}$, ${}_{94}^{239}\text{Pu}$, ${}_{90}^{232}\text{Th}$ — irradiated by neutrons \longrightarrow unstable
- ▶ Fission example

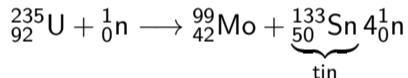

- ▶ Chemical/physical purification

Fission product yield for $^{235}_{92}\text{U}$

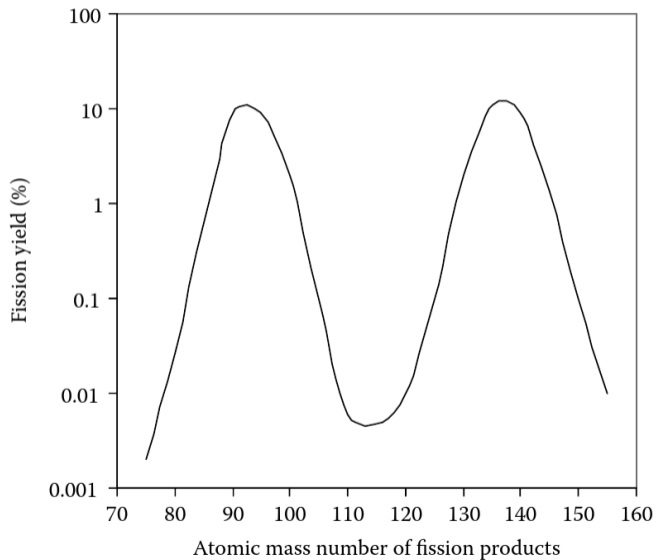

Radionuclides produced by nuclear fission

Isotope	Gamma-Ray Energy (keV)	Half-Life	Fission Yield (%)
^{99}Mo	740	66.02 h	6.1
^{131}I	364	8.05 days	2.9
^{133}Xe	81	5.27 days	6.5
^{137}Cs	662	30 a	5.9

Source: From BRH, 1970.

Radionuclide generator

- ▶ Long half-time parent isotope
- ▶ Short half-time daughter isotope, $\lambda_2 > \lambda_1$

Radionuclide generator

- ▶ Long half-time parent isotope
- ▶ Short half-time daughter isotope, $\lambda_2 > \lambda_1$
- ▶ Daughter activity (for $A_{20} = 0$)

$$A_2 = \frac{\lambda_2}{\lambda_2 - \lambda_1} A_{10} (e^{-\lambda_1 t} - e^{-\lambda_2 t})$$

Radionuclide generator

- ▶ Long half-time parent isotope
- ▶ Short half-time daughter isotope, $\lambda_2 > \lambda_1$
- ▶ Daughter activity (for $A_{20} = 0$)

$$A_2 = \frac{\lambda_2}{\lambda_2 - \lambda_1} A_{10} \left(e^{-\lambda_1 t} - e^{-\lambda_2 t} \right)$$

- ▶ After $\sim 10 T_{1/2}$, **transient equilibrium**

$$A_1 = A_{10} e^{-\lambda_1 t}, \quad A_2 = A_1 \frac{\lambda_1}{\lambda_2 - \lambda_1}$$

Transient equilibrium

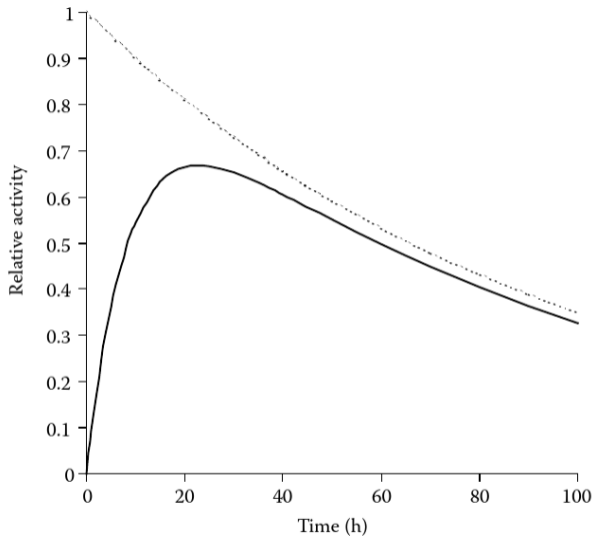

$^{99}_{42}\text{Mo}/^{99\text{m}}_{43}\text{Tc}$ generator, A_1 , A_2

Technetium generator

- ▶ ${}_{42}^{99}\text{Mo}$ produced by fission or neutron bombardment, half-life 67 h
- ▶ Adsorbed to alumina Al_2O_3
- ▶ ${}_{42}^{99}\text{Mo} \xrightarrow{\beta} {}_{43}^{99m}\text{Tc}$ (and 15% to ${}_{43}^{99}\text{Tc}$),
- ▶ ${}_{43}^{99m}\text{Tc}$ half-life 6 h
- ▶ ${}_{43}^{99m}\text{Tc}$ is eluted by physiological saline solution
- ▶ ${}_{43}^{99m}\text{Tc}$ can be chemically manipulated
- ▶ When unused, the ratio ${}_{43}^{99}\text{Tc}/{}_{43}^{99m}\text{Tc}$ increases

Technetium generator (2)

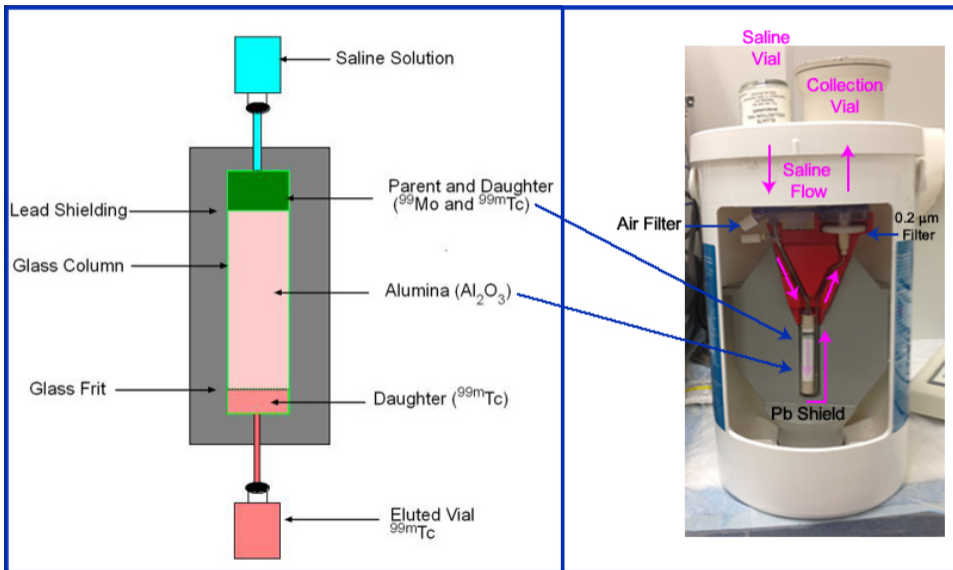

Radionuclides produced by generators

Parent P	Parent Half-Life	Mode of Decay P → D	Daughter D	Mode of Decay of D	Daughter Half-Life	Daughter γ Energy (keV)
^{62}Zn	9.1 h	β^+	^{62}Cu	β^+	9.8 min	511
		EC		EC		1173
^{68}Ge	280 days	EC	^{68}Ga	β^+	68 min	511
				EC		1080
^{81}Rb	4.7 h	EC	$^{81}\text{Kr}^m$	IT	13 s	190
^{82}Sr	25 days	EC	^{82}Rb	EC	76 s	777
				β^+		511
^{99}Mo	66.02 h	β^-	$^{99}\text{Tc}^m$	IT	6.02 h	140
^{113}Sn	115.1 days	EC	$^{113}\text{In}^m$	IT	1.66 h	392
$^{195}\text{Hg}^m$	40 h	IT	$^{195}\text{Au}^m$	IT	30.6 s	262
		EC				

Principles of nuclear imaging

Radioactivity

Radioactive decay

Radionuclide production

Cyklotron

Radiopharmaceuticals

Gamma camera

SPECT

PET

Conclusions

Ion bombardment

- ▶ Charged particles: mostly $p = {}^1_1\text{H}^+$, also ${}^2_1\text{D}^+$, ${}^3_2\text{He}^{2+}$, ${}^4_2\text{He}^{2+}$
- ▶ Accelerated to high energies by a linear accelerator or cyclotron (typical $E_p \sim 18 \text{ MeV}$)
- ▶ hit target, get absorbed in the nucleus, knock out a neutron
- ▶ Typical reactions

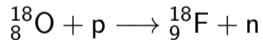
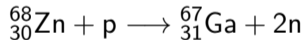
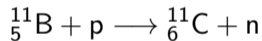

- ▶ neutron deficit $\longrightarrow \beta^+$ emitters (or EC), mostly short-lived

Radionuclides produced by ion bombardment

Radionuclide	Principal Gamma-Ray Energy (keV)	Half-Life	Production Reaction
^{11}C	511 (β^+)	20.4 min	$^{14}\text{N}(\text{p}, \alpha)^{11}\text{C}$
^{13}N	511 (β^+)	9.96 min	$^{13}\text{C}(\text{p}, \text{n})^{13}\text{N}$
^{15}O	511 (β^+)	2.07 min	$^{15}\text{N}(\text{p}, \text{n})^{15}\text{O}$
^{18}F	511 (β^+)	109.7 min	$^{18}\text{O}(\text{p}, \text{n})^{18}\text{F}$
^{67}Ga	93, 184, 300	78.3 h	$^{68}\text{Zn}(\text{p}, 2\text{n})^{67}\text{Ga}$
^{111}In	171, 245	67.9 h	$^{112}\text{Cd}(\text{p}, 2\text{n})^{111}\text{In}$
^{120}I	511 (β^+)	81 min	$^{127}\text{I}(\text{p}, 8\text{n})^{120}\text{Xe} \rightarrow ^{120}\text{I}$
^{123}I	159	13.2 h	$^{124}\text{Te}(\text{p}, 2\text{n})^{123}\text{I}$ $^{127}\text{I}(\text{p}, 5\text{n})^{123}\text{Xe} \rightarrow ^{123}\text{I}$
^{124}I	511 (β^+)	4.2 days	$^{124}\text{Te}(\text{p}, \text{n})^{124}\text{I}$
^{201}Tl	68–80.3	73 h	$^{203}\text{Tl}(\text{p}, 3\text{n})^{201}\text{Pb} \rightarrow ^{201}\text{Tl}$

Charged particle in a magnetic field

Cyclotron principle

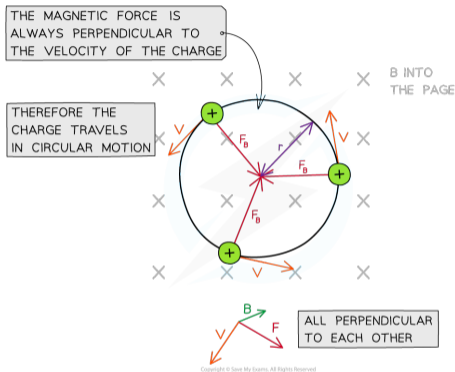

- ▶ Magnetic (Lorentz) force $\mathbf{F} = q\mathbf{v} \times \mathbf{B}$, perpendicular to \mathbf{v} and $\mathbf{B} \rightarrow$ circular motion

Charged particle in a magnetic field

Cyclotron principle

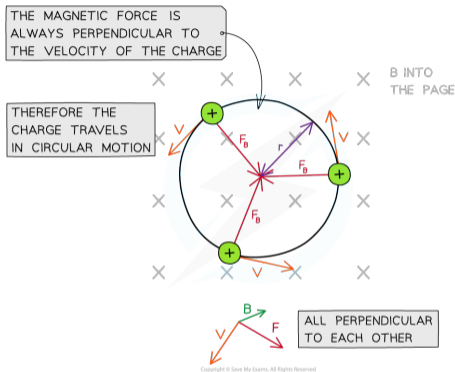

- ▶ Magnetic (Lorentz) force $\mathbf{F} = q\mathbf{v} \times \mathbf{B}$, perpendicular to \mathbf{v} and $\mathbf{B} \rightarrow$ circular motion
- ▶ Centripetal=centrifugal force $F = mv^2/r$

Charged particle in a magnetic field

Cyclotron principle

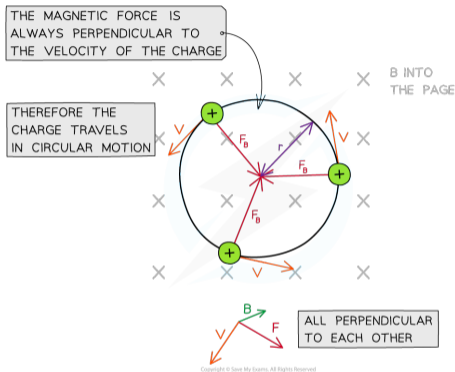

- ▶ Magnetic (Lorentz) force $\mathbf{F} = q\mathbf{v} \times \mathbf{B}$, perpendicular to \mathbf{v} and $\mathbf{B} \rightarrow$ circular motion
- ▶ Centripetal=centrifugal force $F = mv^2/r$
- ▶ $r = \frac{mv}{Bq}$, since $v \sim r \sim l \rightarrow$ constant f

Charged particle in a magnetic field

Cyclotron principle

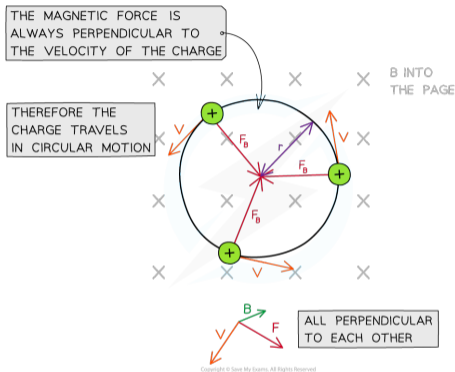

- ▶ Magnetic (Lorentz) force $\mathbf{F} = q\mathbf{v} \times \mathbf{B}$, perpendicular to \mathbf{v} and $\mathbf{B} \rightarrow$ circular motion
- ▶ Centripetal=centrifugal force $F = mv^2/r$
- ▶ $r = \frac{mv}{Bq}$, since $v \sim r \sim l \rightarrow$ constant f
- ▶ Neglecting relativistic mass increase, electrode shape

Cyclotron

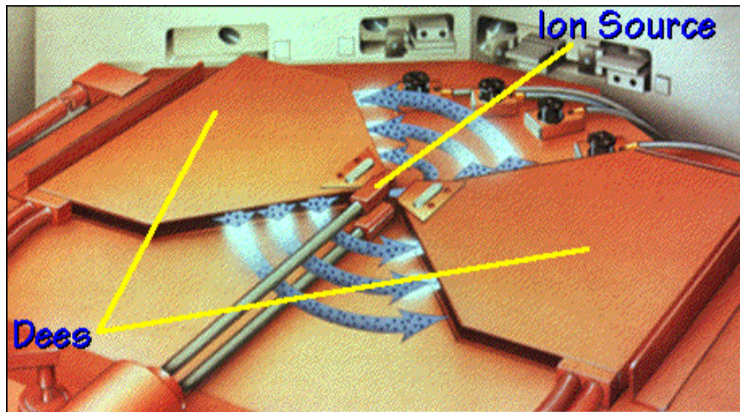

- ▶ Vacuum
- ▶ Ion source (batch), mostly H^-
- ▶ Hollow 'D' electrodes, high frequency AC voltage (MHz)
- ▶ Magnetic field (oriented vertically)

Cyclotron

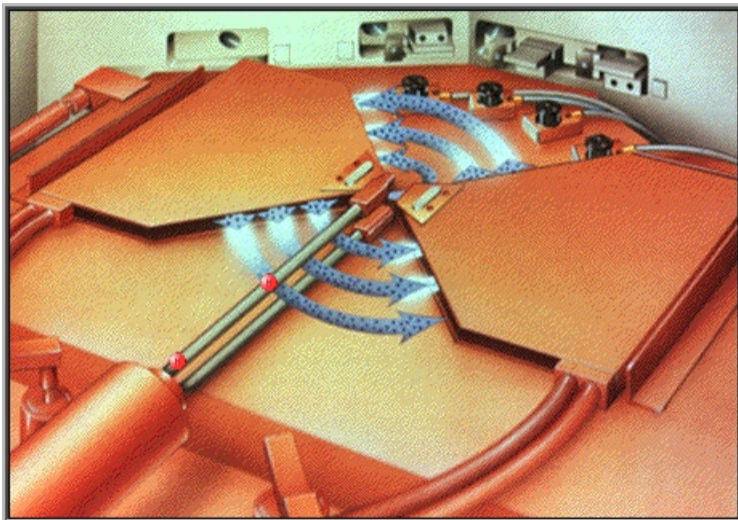

- ▶ Vacuum
- ▶ Ion source (batch), mostly H^-

Real cyclotron

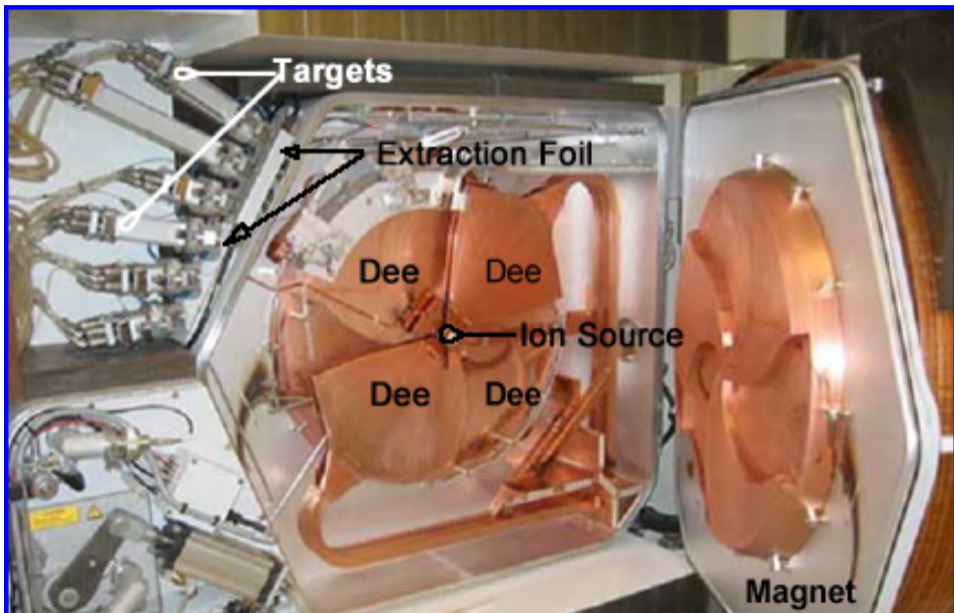

Real cyclotron

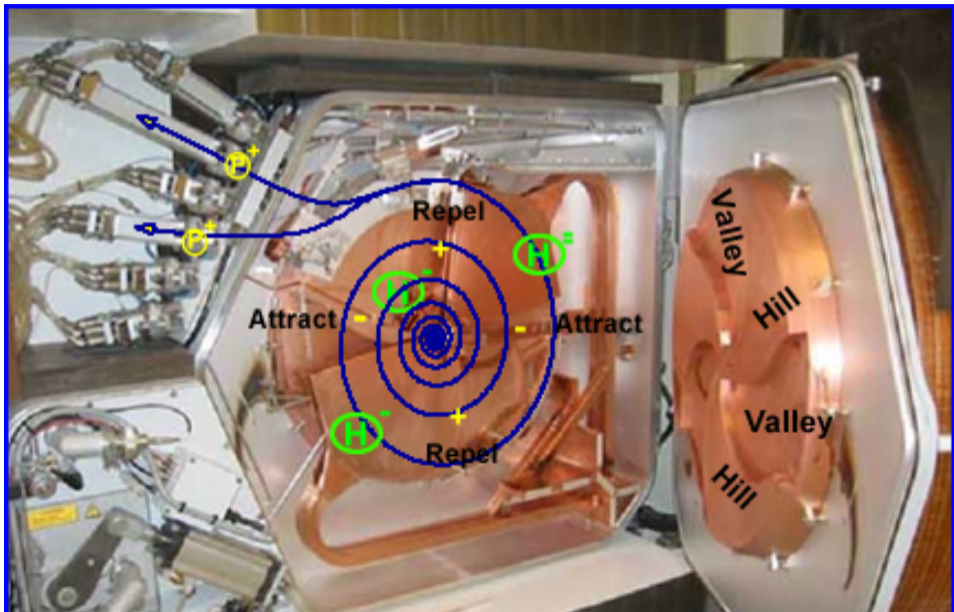

Carousel

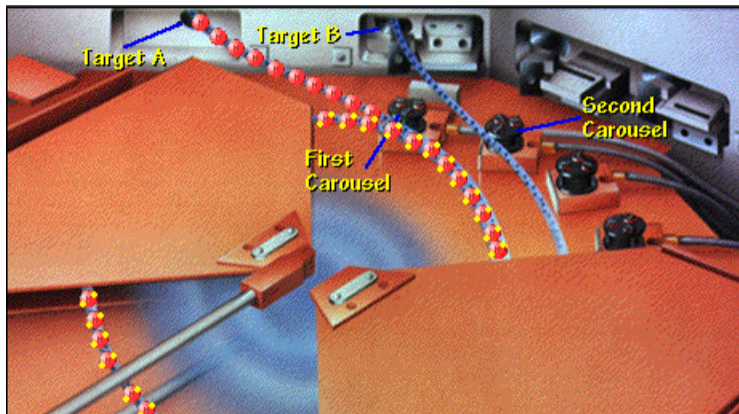

- ▶ after ~ 100 s of cycles
- ▶ H^- ion hits a thin carbon foil
- ▶ \rightarrow loses electrons, converted $p = \text{H}^+$
- ▶ \rightarrow opposite curvature
- ▶ Only part of the beam is deviated

Carousel

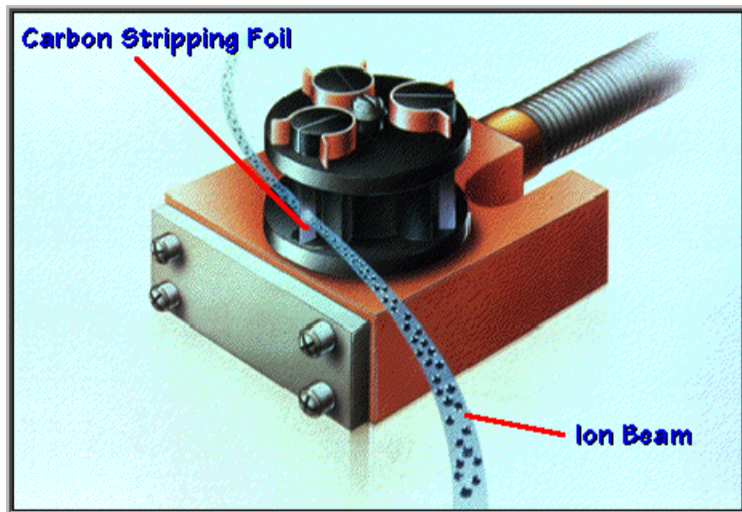

- ▶ after ~ 100 s of cycles
- ▶ H^- ion hits a thin carbon foil

Carousel

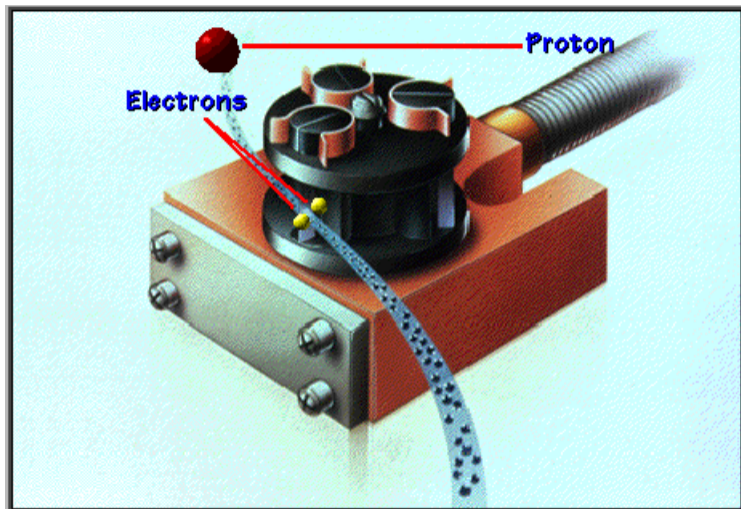

- ▶ after ~ 100 s of cycles
- ▶ H^- ion hits a thin carbon foil

Target chamber

Reakční komora

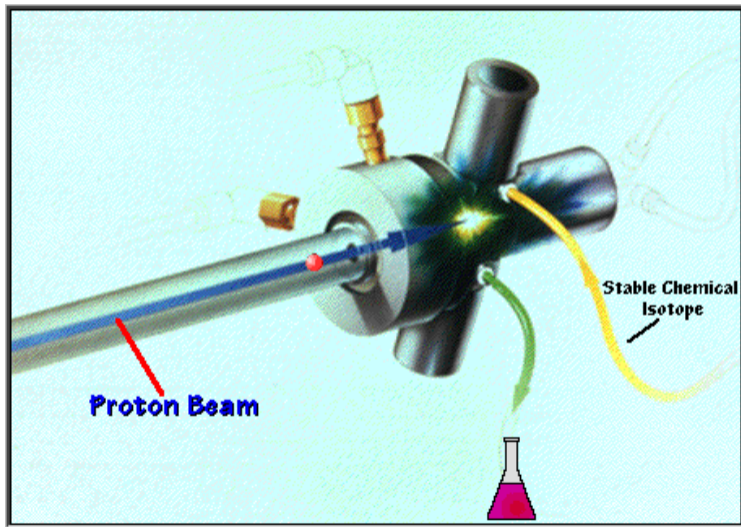

- Filled with a stable isotope

Target chamber

Reakční komora

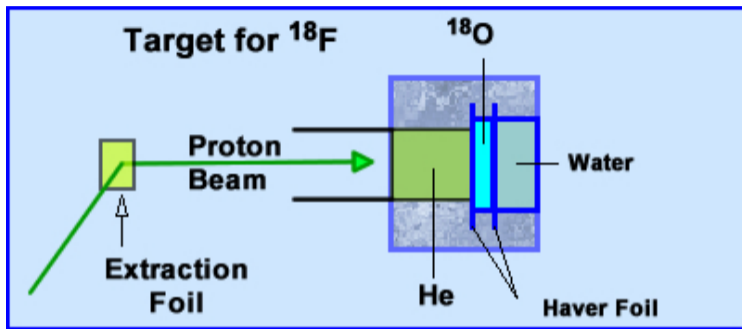

- ▶ $^{18}_8\text{O}$ — rare (0.2%), enrichment needed (distillation, very small ΔT_{boil})
- ▶ Cooling needed (by water)
- ▶ Thin cobalt alloy foils (havar)
- ▶ Every few hours, $^{18}_9\text{F}$ can be extracted

Target chamber

Reakční komora

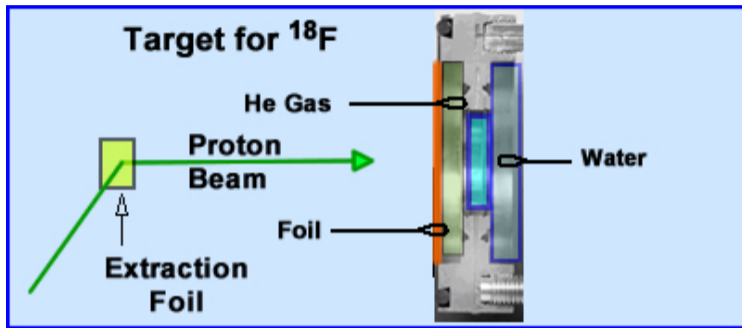

- ▶ ^{18}O — rare (0.2%), enrichment needed (distillation, very small ΔT_{boil})
- ▶ Cooling needed (by water)
- ▶ Thin cobalt alloy foils (havar)
- ▶ Every few hours, ^{18}F can be extracted

Biosynthesizer

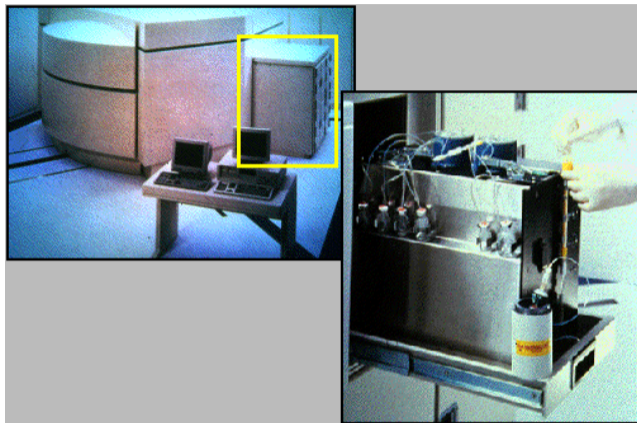

- ▶ Radiopharmaceutical — radioactively labeled biologically active/compatible chemical compound.
- ▶ Quantitative & qualitative imaging of physiological processes.

Principles of nuclear imaging

Radioactivity

Radioactive decay

Radionuclide production

Cyklotron

Radiopharmaceuticals

Gamma camera

SPECT

PET

Conclusions

Administration, distribution and excretion

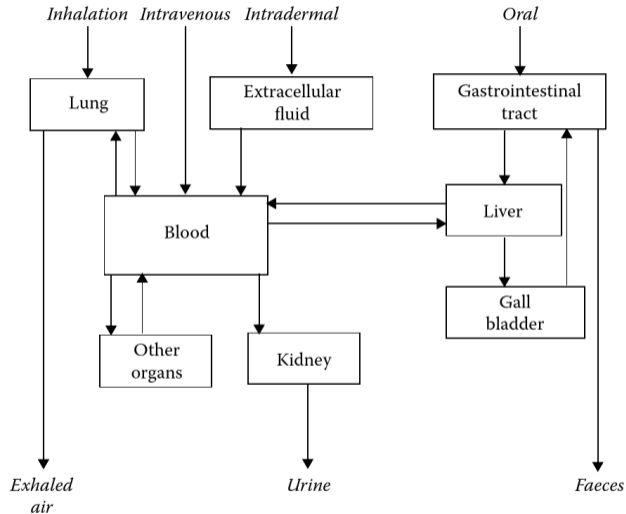

Must traverse membranes to get to the target organ.

Administration of radiopharmaceuticals

- ▶ Mostly physiological (saline) solution
- ▶ Blood-brain barrier
 - ▶ Intravenously administered contrast agent does not get to the brain
 - ▶ Contrast agent administered to the cerebro-spinal fluid only gets to the brain and spine.

Administration of radiopharmaceuticals

- ▶ Mostly physiological (saline) solution
- ▶ Blood-brain barrier
 - ▶ Intravenously administered contrast agent does not get to the brain
 - ▶ Contrast agent administered to the cerebro-spinal fluid only gets to the brain and spine.
- ▶ Other metabolic barriers (blood-ocular, blood-air, ...)

Administration of radiopharmaceuticals

- ▶ Mostly physiological (saline) solution
- ▶ Blood-brain barrier
 - ▶ Intravenously administered contrast agent does not get to the brain
 - ▶ Contrast agent administered to the cerebro-spinal fluid only gets to the brain and spine.
- ▶ Other metabolic barriers (blood-ocular, blood-air, ...)
- ▶ Imaging affinity and metabolism speed

Radiopharmaceutical construction

Radionuclide + carrier molecule (+ probe)

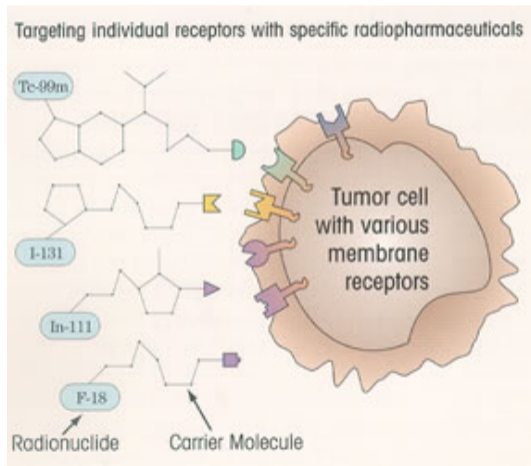

Radiopharmaceuticals (tracers) for SPECT imaging

Radionuclide	Pharmaceutical	Indication/Use	Typical Administered Activity (MBq)
^{67}Ga	Citrate	Tumour imaging, infection/ inflammation imaging	150 ^a
$^{81}\text{Kr}^m$	Krypton gas	Lung ventilation imaging	6000 ^a
$^{99}\text{Tc}^m$	Albumin	Cardiac blood-pool imaging, peripheral vascular imaging	800 ^a
$^{99}\text{Tc}^m$	Colloids, including tin colloid and sulphur colloid	Oesophageal transit and reflux Liver imaging Bone marrow imaging, GI bleeding	40 ^a 80 ^a , 200 (SPECT) ^a 400 ^a
$^{99}\text{Tc}^m$	DTPA	Lung ventilation imaging (aerosol) Renal imaging/renography Brain imaging (static) First-pass blood-flow studies	80 ^a 300 ^a 500 ^a , 800 (SPECT) ^a 800 ^a
$^{99}\text{Tc}^m$	DMSA	Renal imaging (DMSA(III)) Tumour imaging (DMSA(V))	80 ^a 400 ^a
$^{99}\text{Tc}^m$	ECD	Brain imaging	500 ^a
$^{99}\text{Tc}^m$	Erythrocytes (normal)	GI bleeding Cardiac blood-pool imaging or peripheral vascular imaging	400 ^a 800 ^a
$^{99}\text{Tc}^m$	Erythrocytes (heat denatured)	Spleen imaging	100 ^a
$^{99}\text{Tc}^m$	Exametazime	Cerebral blood-flow imaging (SPECT)	500 ^a
$^{99}\text{Tc}^m$	Iminodiacetates (IDAs)	Functional biliary system imaging	150 ^a
$^{99}\text{Tc}^m$	Leucocytes	Infection/inflammation imaging	200 ^a

Radiopharmaceuticals (tracers) for SPECT imaging

Radionuclide	Pharmaceutical	Indication/Use	Typical Administered Activity (MBq)
^{99m}Tc	Macroaggregated albumin	Lung perfusion imaging	100 ^a , 200 (SPECT) ^a
^{99m}Tc	MAG3	Renal imaging/renography	100 ^a
		First-pass blood-flow imaging	200 ^a
^{99m}Tc	Nanocolloids	Lacrimal drainage	4 ^a
		Sentinel node or lymph node imaging	20 ^a
^{99m}Tc	Pertechnetate	Micturating cystogram	25 ^a
		Thyroid uptake	40 ^a
		Thyroid imaging, salivary gland imaging	80 ^a
		Ectopic gastric mucosa imaging (Meckel's)	400 ^a
		First-pass blood-flow imaging	800 ^a
^{99m}Tc	Phosphonate and phosphate compounds	Bone imaging	600 ^a , 800 (SPECT) ^a
^{99m}Tc	Sestamibi	Myocardial imaging	300 ^a , 400 (SPECT) ^a
		Tumour imaging, breast imaging	900 ^a
^{99m}Tc	Sulesomab	Infection/inflammation imaging	750 ^a
^{99m}Tc	Technegas	Lung ventilation imaging	40 ^a
^{99m}Tc	Tetrofosmin	Myocardial imaging	300 ^a , 400 (SPECT) ^a
		Parathyroid imaging	900 ^a
^{111}In	Capromab Pendetide	Biopsy-proven prostate carcinoma imaging	185 ^b
^{111}In	DTPA	GI transit	10 ^a
		Cisternography	30 ^a

Radiopharmaceuticals (tracers) for SPECT imaging

Radionuclide	Pharmaceutical	Indication/Use	Typical Administered Activity (MBq)
^{111}In	Leucocytes	Infection/inflammation imaging	20 ^a
^{111}In	Pentetreotide	Somatostatin receptor imaging	110 ^a , 220 (SPECT) ^a
^{111}In	Platelets	Thrombus imaging	20 ^a
^{123}I	Iodide	Thyroid uptake	2 ^a
		Thyroid imaging	20 ^a
		Thyroid metastases imaging	400 ^a
^{123}I	Ioflupane	Striatal dopamine transporter visualisation	185 ^a
^{123}I	<i>m</i> IBG	Neuroectodermal tumour imaging	400 ^a
^{131}I	<i>m</i> IBG	Neuroectodermal tumour imaging	20 ^a
^{131}I	Iodide	Thyroid uptake	0.2 ^a
		Thyroid metastases imaging	400 ^a
^{133}Xe	Xenon gas	Lung ventilation studies	400 ^a
^{201}Tl	Thallous chloride	Myocardial imaging	80–120 ^a
		Parathyroid imaging	80 ^a
		Tumour imaging	150 ^a

Radiopharmaceuticals (tracers) for SPECT imaging

Radionuclide	Pharmaceutical	Indication/Use	Typical Administered Activity (MBq)
^{111}In	Leucocytes	Infection/inflammation imaging	20 ^a
^{111}In	Pentetreotide	Somatostatin receptor imaging	110 ^a , 220 (SPECT) ^a
^{111}In	Platelets	Thrombus imaging	20 ^a
^{123}I	Iodide	Thyroid uptake	2 ^a
		Thyroid imaging	20 ^a
		Thyroid metastases imaging	400 ^a
^{123}I	Ioflupane	Striatal dopamine transporter visualisation	185 ^a
^{123}I	<i>m</i> IBG	Neuroectodermal tumour imaging	400 ^a
^{131}I	<i>m</i> IBG	Neuroectodermal tumour imaging	20 ^a
^{131}I	Iodide	Thyroid uptake	0.2 ^a
		Thyroid metastases imaging	400 ^a
^{133}Xe	Xenon gas	Lung ventilation studies	400 ^a
^{201}Tl	Thallos chloride	Myocardial imaging	80–120 ^a
		Parathyroid imaging	80 ^a
		Tumour imaging	150 ^a

and others: selenium ^{75}Se . . .

Pharmaceuticals for PET imaging

Oxygen ^{15}O

- ▶ Half-life ^{15}O is 2.5 min.
- ▶ **Carbon dioxide (CO_2)** — brain blood flow
- ▶ **Oxygen (O_2)** — oxygen consumption in myocardium, tumors
- ▶ **Water (H_2O)** — myocardium perfusion
 - + not influenced by metabolism
 - background ^{15}O activity in lungs and blood vessels

Nitrogen ^{13}N

- ▶ Half-life ^{13}N is 10 min.
- ▶ **Ammonia** (NH_3) — myocardium perfusion, blood flow
 - ▶ metabolized in v tissue

Carbon ^{11}C

- ▶ Half-life ^{11}C is 20.4 min.
- ▶ **Acetic acid** (CH_3COOH) — myocardium perfusion, tumor metabolism
- ▶ **Cocain, carfentanil, . . .** — brain opioid receptor mechanisms
- ▶ **Deprenyl** — monoamine oxidase inhibitor, to study Parkinson disease
- ▶ **Leucin, methionine. . .** — amino acid tracer, brain tumor detection
- ▶ . . .

Fluorine ^{18}F

- ▶ Half-time ^{18}F is 109 min.
- ▶ **Haloperidol** — neuroreceptor ligand, drug effects
- ▶ **Sodium fluoride Na^{18}F^-** — skeletal imaging, osseous blood-flow, metastases.
Better signal than ^{99m}Tc
- ▶ **Fluorodopa...** — metabolised to dopamine, neurotransmitter studies
- ▶ **Flourouracil...** — drug, nucleic acid tracer, chemotherapy dosage
- ▶ **Fluorodeoxyglucose (FDG)** — glucose metabolism ; neurology, cardiology, oncology. Penetrates blood-brain barrier

Delivery Strategies: Metabolic pathways

FDG
2-fluoro-2-deoxy-glucose

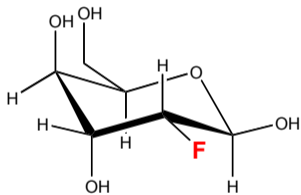

B-D-glucose

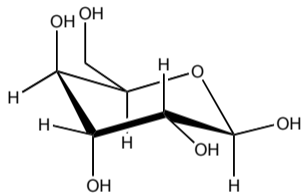

FDG usage

- ▶ Brain function mapping
- ▶ ... *glucose* provides energy to the brain (for adults ~ 100 g/den)

FDG usage

- ▶ Brain function mapping
- ▶ ... *glucose* provides energy to the brain (for adults ~ 100 g/den)
- ▶ Tumor mapping
- ▶ ... tumors have no metabolic barrier

FDG in Oncology

- FDG transport into tumors occurs at a *higher* rate than in the surrounding normal tissues.
- FDG is de-phosphorylated and can then leave the cell.
- The dephosphorylation occurs at a *slower* rate in tumors.

Applications of FDG

- Locating unknown primaries
- Differentiation of tumor from normal tissue
- Pre-operative staging of disease (lung, breast, colorectal, melanoma, H&N, pancreas)
- Recurrence vs necrosis
- Recurrence vs post-operative changes (limitations with FDG)
- Monitoring response to therapy

Rubidium ^{82}Rb

- ▶ Half-life ^{82}Rb is 1.25 min.
- + Produced by a generator from Sr, (no cyclotron needed)
 - Long positron free path \rightarrow low spatial spatial resolution.
- + Short half-life \rightarrow good temporal resolution
 - Short half-life \rightarrow weak signal
- ▶ Myocard perfusion
- ▶ Blood-brain barrier study

Principles of nuclear imaging

Radioactivity

Gamma camera

SPECT

PET

Conclusions

Gamma camera

Scintigraphy



Single Photon Detection with Gamma Camera

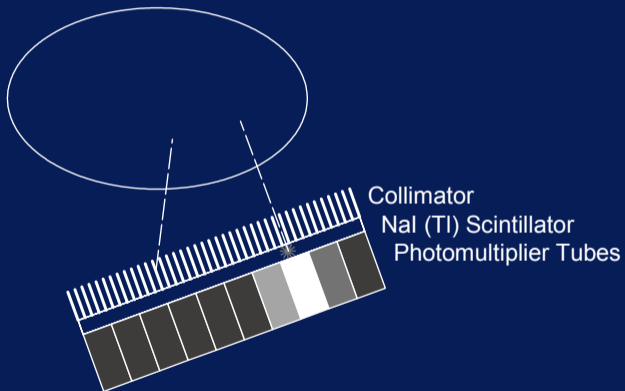

Scintillator materials

Scintillator	Density (g cm ⁻³)	Effective Z	Relative light yield	Decay constant (ns)	Wavelength of emission (nm)
Sodium Iodide (NaI)	3.67	50	100	230	410
Bismuth Germanate (BGO)	7.13	74	12	300	480
Barium Fluoride (BaF ₂)	4.89	54	5 15	0.6 - 0.8 630	220 (195) 310

- ▶ High Z advantageous
- ▶ BGO good for 511 keV
- ▶ For speed, use BaF₂ — UV light produced

Photon Counting Detector (PCD)

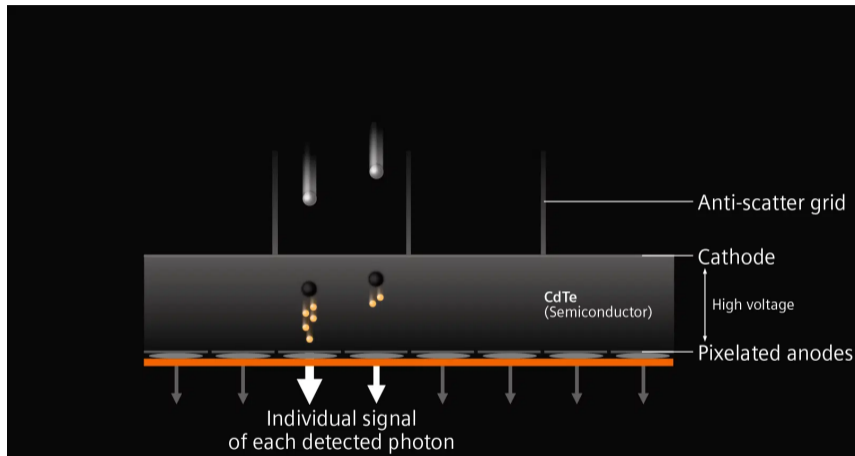

- ▶ Signal propagation directed by electric field
- ▶ High quantum efficiency
- ▶ High spacial resolution

Principles of nuclear imaging

Radioactivity

Gamma camera

Artefacts

Clinical applications of gamma camera

SPECT

PET

Conclusions

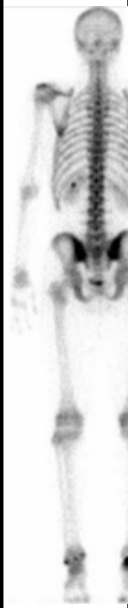

Artifacts: scattering

Scattering of photons in patient

- Because of limited energy resolution of the detector, primary and scattered photons which pass the collimator can not be classified properly. (In the ideal case, only primary photons are used to contribute to the image)
- Effects: haziness of images, quantization is degraded.

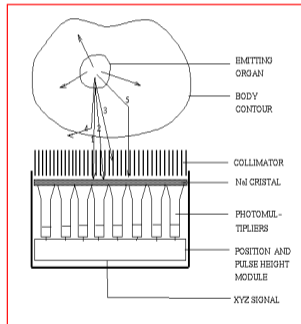

Artifacts: collimator blur

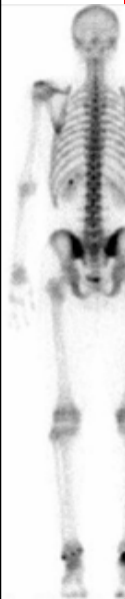

Collimator blur

- Because of the size of the holes, photons which are not entering the detector exactly perpendicular to the detector surface are also detected. This introduces uncertainty about the exact path the photon traveled.
- Effect: blurring which increases with larger holes. Trade off between sensitivity and resolution has to be found.

Artifacts: noise

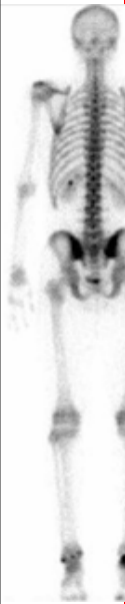

Noise due to limited number of detected photons

- Doses and scanning time are limited while the efficiency of the collimator is also limited.
- Effects: Noise in the images. Low pass digital filtering required. This results in reduced resolution. Tradeoffs between dose, scanning time and collimator hole size have to be made.

Phantom experiments

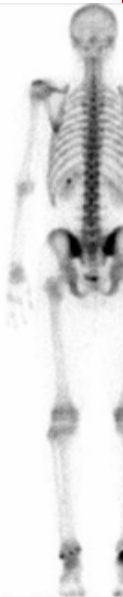

Ground truth
phantom

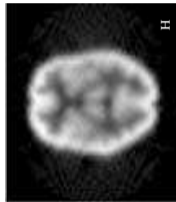
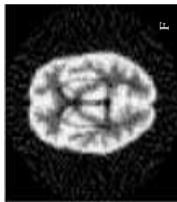

Detector +
attenuation

Detector +
attenuation +
scatter

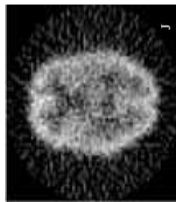
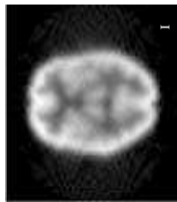

Detector +
attenuation +
scatter +
noise

Principles of nuclear imaging

Radioactivity

Gamma camera

Artefacts

Clinical applications of gamma camera

SPECT

PET

Conclusions

Scintigram

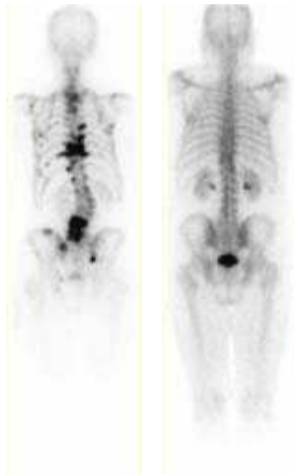
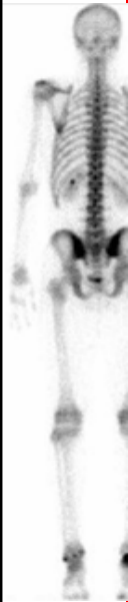

Medical Image Formation Biomedical Image Sciences 2005 - 2006

Lung scintigraphy

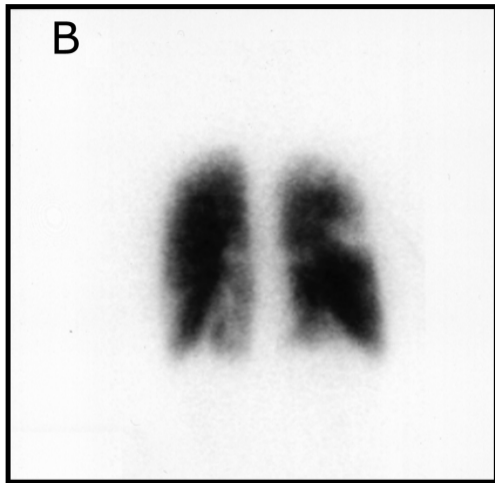
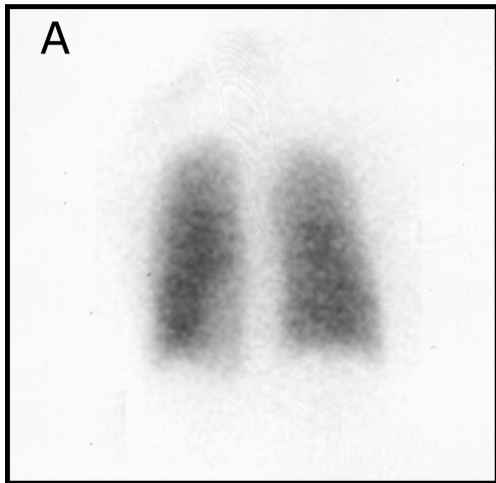

Most frequent use.

Ventilation (Xe), perfusion (^{99m}Tc). Pulmonary embolism (blocked artery)

Principles of nuclear imaging

Radioactivity

Gamma camera

SPECT

PET

Conclusions



SPECT

Single Photon Emission Computed Tomography (SPECT)

Image is acquired by rotating the γ -camera around the patient and taking images at different angles

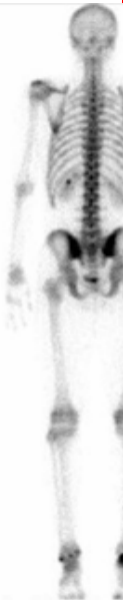

SPECT

- Patient is injected with a γ -emitting radio-pharmaceutical
- Preferred energy: 100-250 keV
- Use of collimators
- Collimated camera projections are acquired from different equidistant angles (30-120 projections over 180-360 degrees)
- Images are reconstructed using Filtered Back Projection (FBP) or Iterative Reconstruction
- Resolution: 12-20 mm
- To increase count-rate often two or three γ -camera heads are used

SPECT

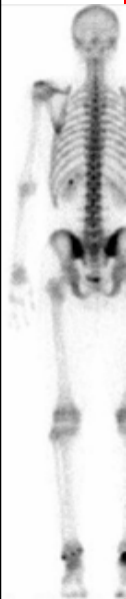

Medical Image Formation Biomedical Image Sciences 2005 - 2006

SPECT, brain imaging



Image Reconstruction Methods

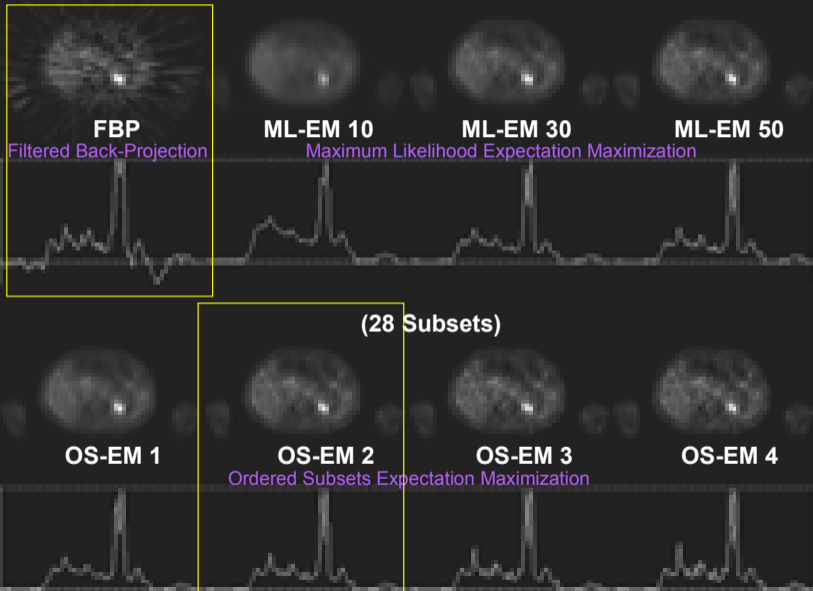

Principles of nuclear imaging

Radioactivity

Gamma camera

SPECT

Princip

Clinical applications of SPECT

PET

Conclusions

SPECT: Applications

Cardiac Imaging

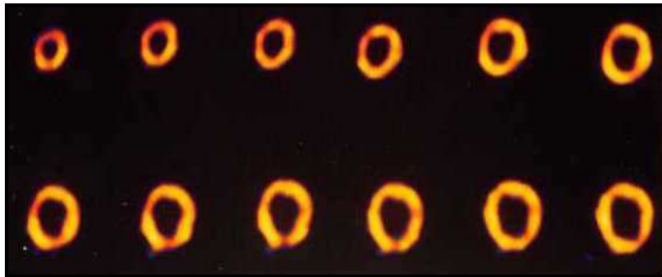

SPECT, Brain perfusion

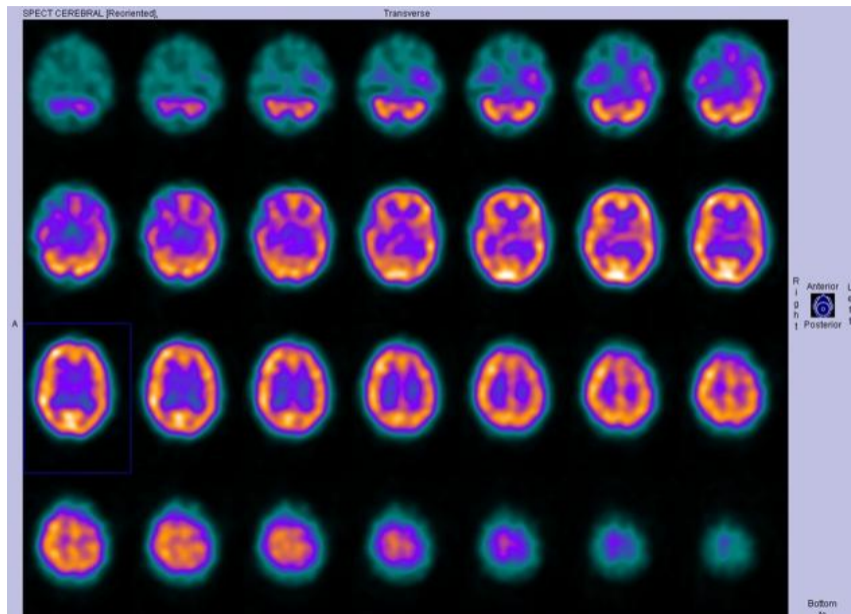

SPECT: Applications

Epilepsy

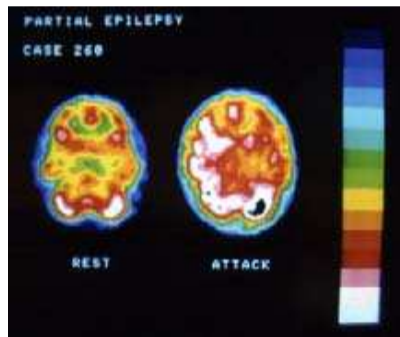

SPECT, Whole-body imaging

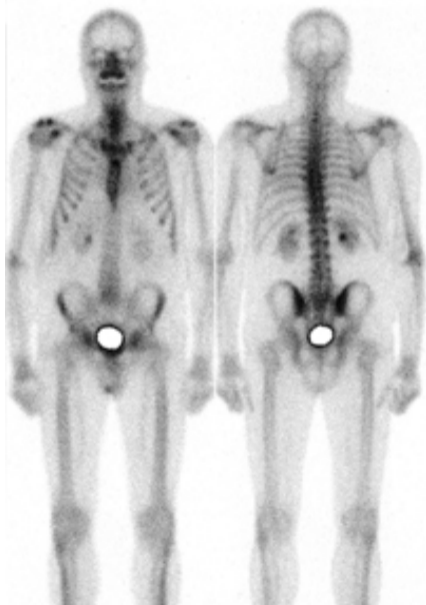

SPECT, Whole-body imaging

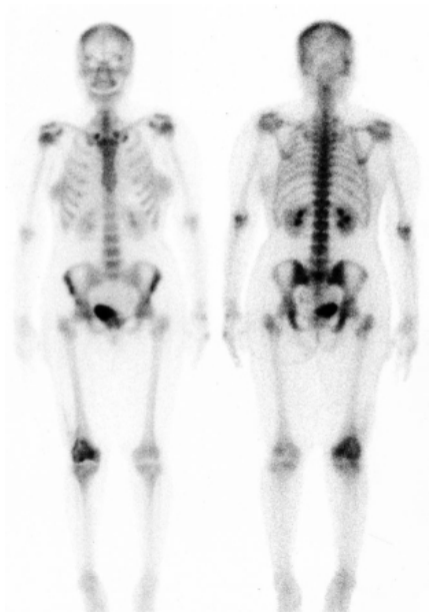

Principles of nuclear imaging

Radioactivity

Gamma camera

SPECT

PET

Conclusions

Principle of PET

A₁ Positron emission in the brain

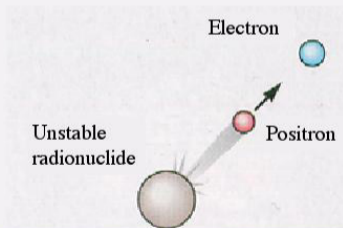

A₂ Positron and electron annihilation and emission of gamma rays

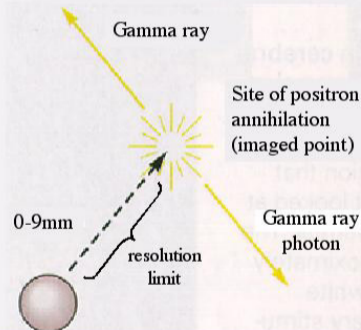

From: Principles of Neural Science (4th. Ed.) Kandel, Schwartz, & Jessell, p. 377.

Columbia fMRI



PET: annihilation

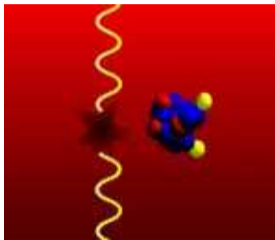
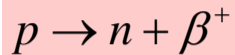

Annihilation
Coincidence
Detection

Isotope	Maximum Positron Range (mm)
F-18	2.6
C-11	3.8
Ga-68	9.0
Rb-82	16.5

Medical Image Formation Biomedical Image Sciences 2005 - 2006

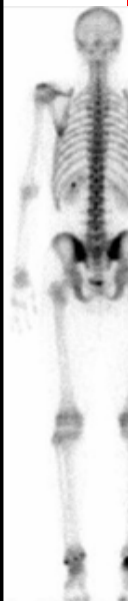

Gamma Ray Detections to Location of Function

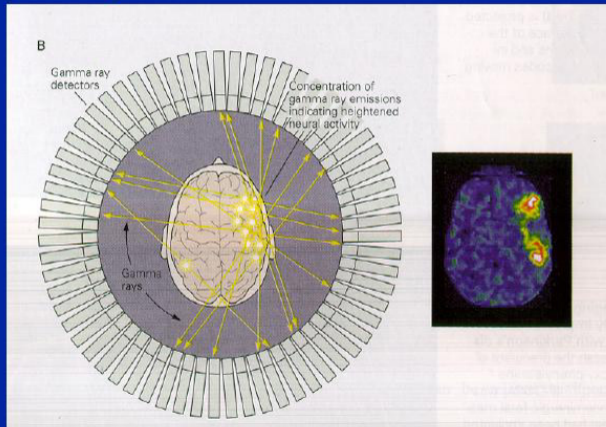

From: Principles of Neural Science (4th. Ed.) Kandel, Schwartz, & Jessell, p. 377.



PET

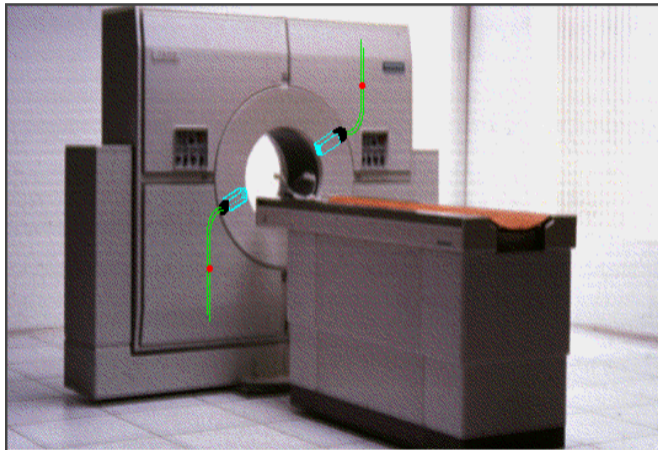
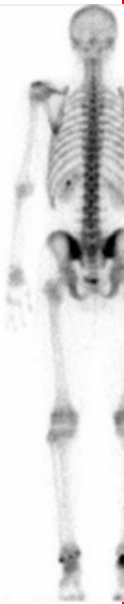

Medical Image Formation Biomedical Image Sciences 2005 - 2006

PET

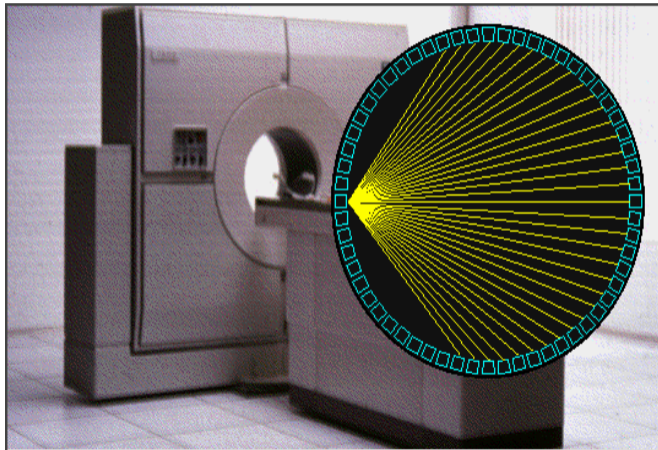
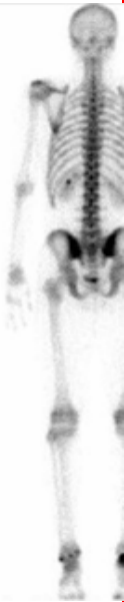

Medical Image Formation Biomedical Image Sciences 2005 - 2006

PET

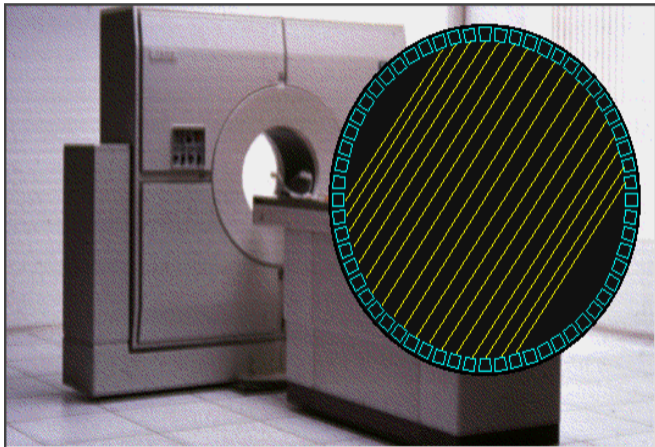

Medical Image Formation Biomedical Image Sciences 2005 - 2006

PET

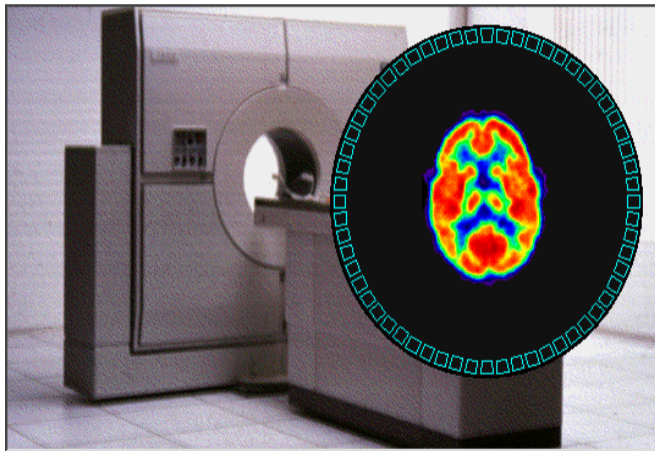
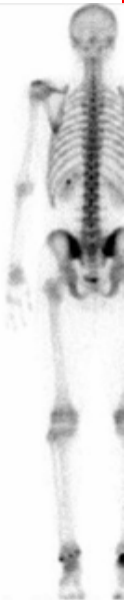

Medical Image Formation Biomedical Image Sciences 2005 - 2006

Coincidence Event

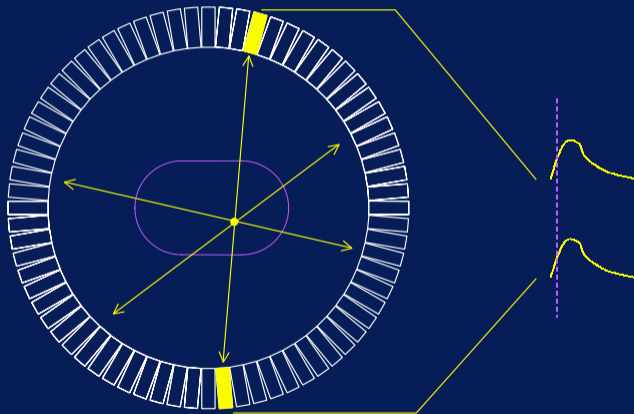

Electronic collimation

- ▶ Associate detections within interval τ (a few ns)
- ▶ Start timer and wait for the second detection \longrightarrow increment count
- ▶ *List mode* — store detections with time stamps, postprocess
- ▶ No lead collimators \longrightarrow higher sensitivity wrt SPECT

Time of Flight PET

- ▶ Measure time interval between coincident photons

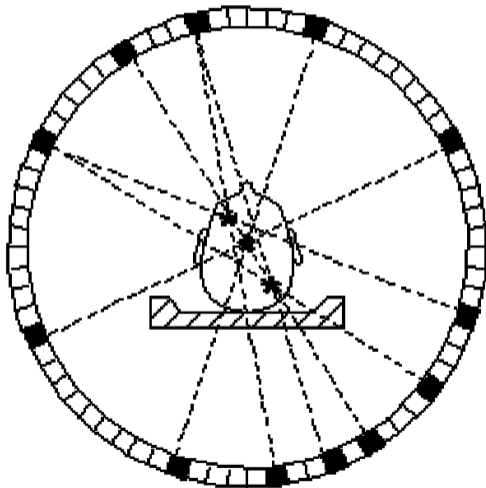

Multiple Rings, 2D – 3D

For n detector rings:

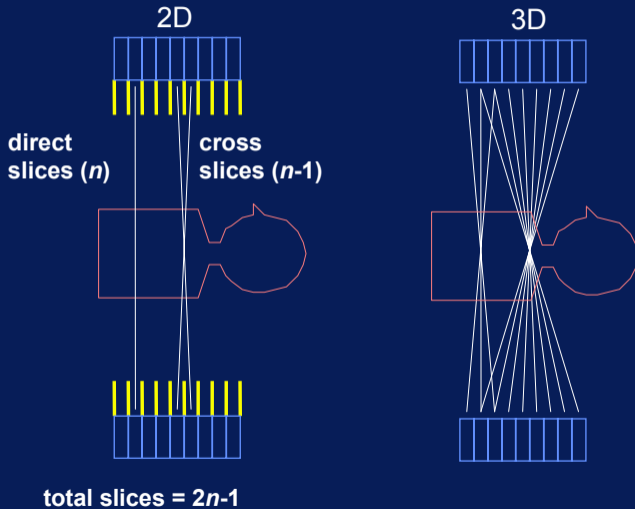

Principles of nuclear imaging

Radioactivity

Gamma camera

SPECT

PET

Principle

Artefacts and corrections

Clinical applications of PET

Kinetic studies

Conclusions

Scattered Coincidence Event

In-Plane

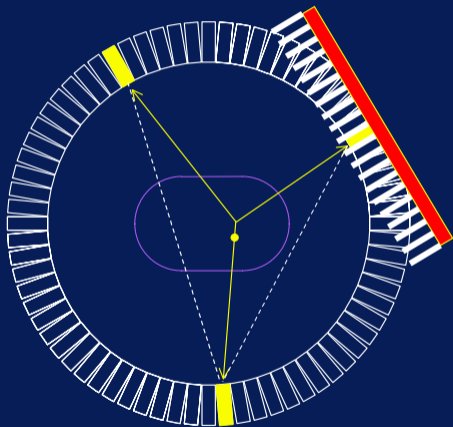

Out-of-Plane

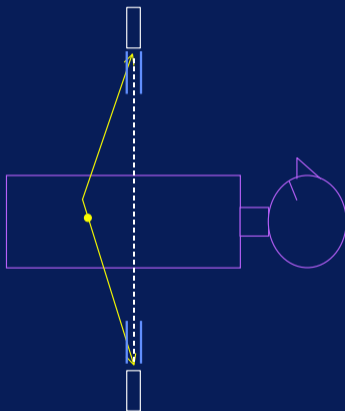

Scatter Fraction $S/(S+T)$

With septa ~10-20%

w/o septa ~30-80%

Random Coincidence Event

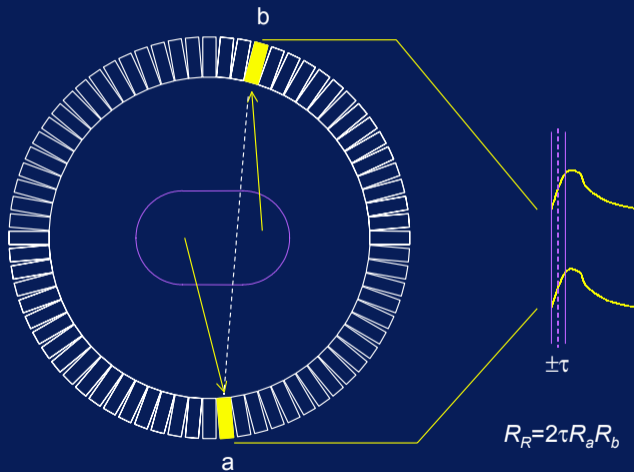

Detector failure

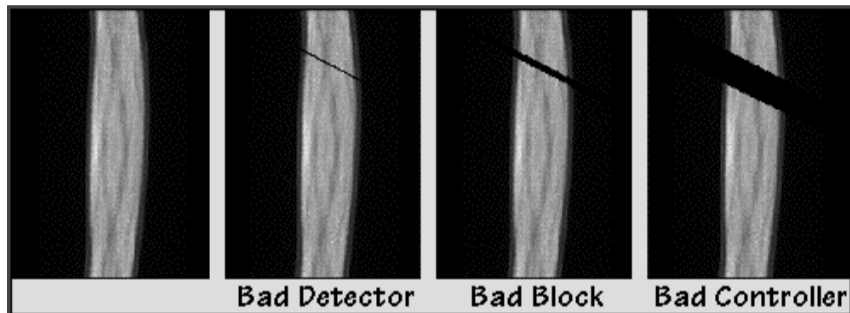

Sinogram

Detector failure

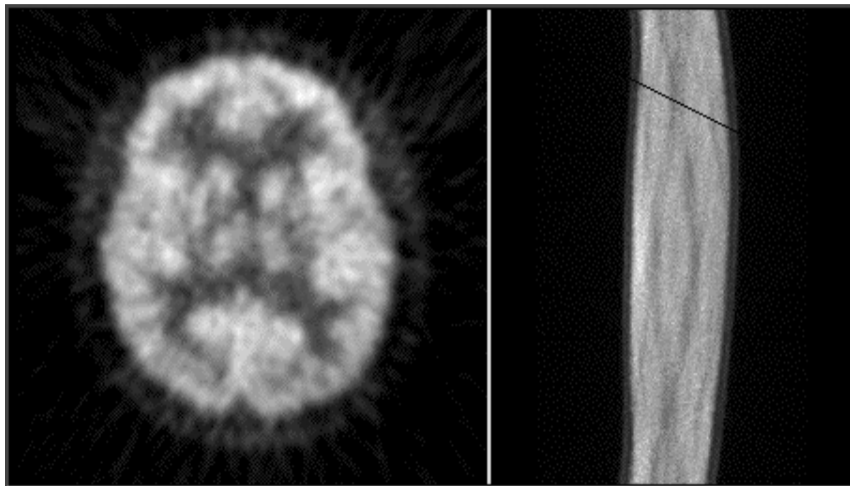

Rekonstrukce

Patient motion

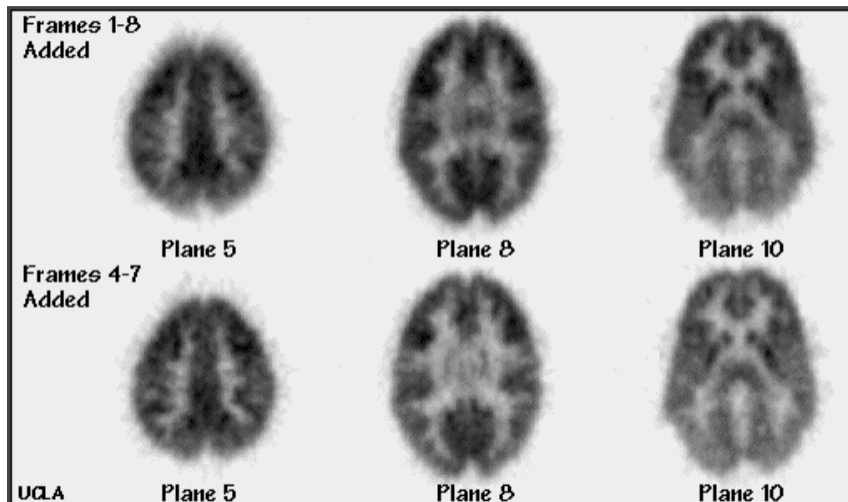

Lower row only uses images without motion.

Patient Size Variations

136 kg

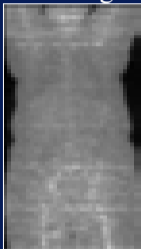

80 kg

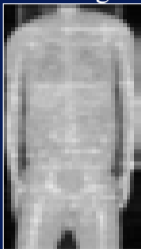

53 kg

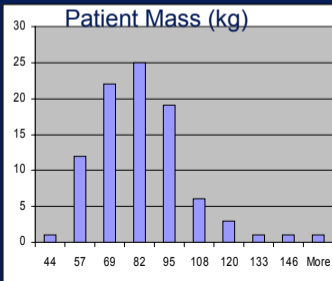
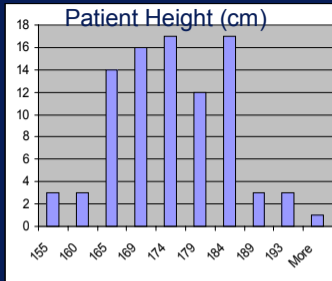
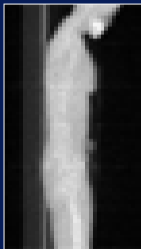
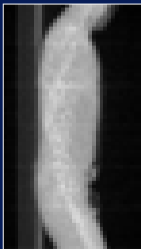
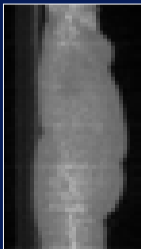
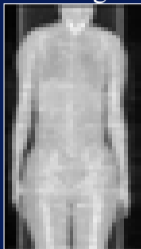

Coincidence Attenuation

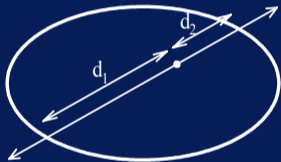

$$\begin{aligned}P_C &= P_1 P_2 \\&= e^{-\mu \cdot d_1} e^{-\mu \cdot d_2} \\&= e^{-\mu \cdot (d_1 + d_2)}\end{aligned}$$

Annihilation radiation emitted along a particular line of response has the same attenuation probability, regardless of where it originated on the line.

Attenuation Effects

AC

NAC

x-ray CT

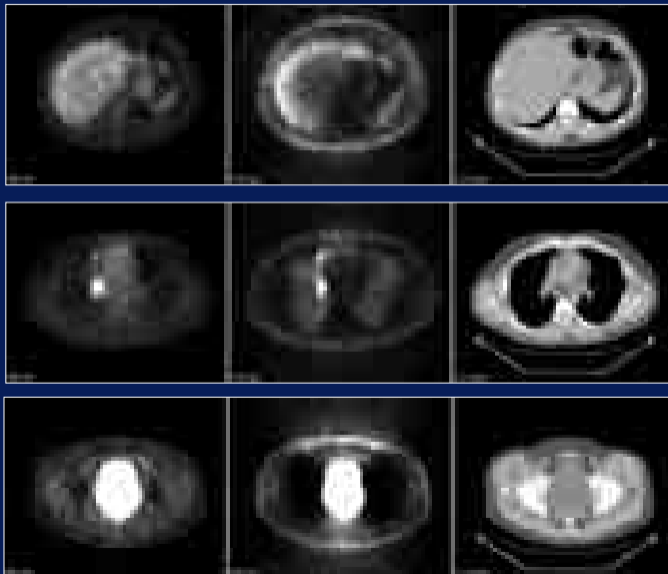

Calculated Attenuation Correction

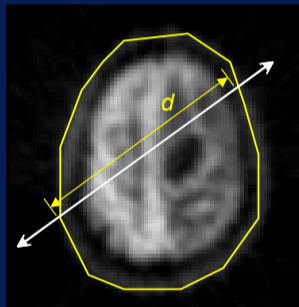

$$I = I_0 e^{-\mu d}$$

Transmission Attenuation Measurement

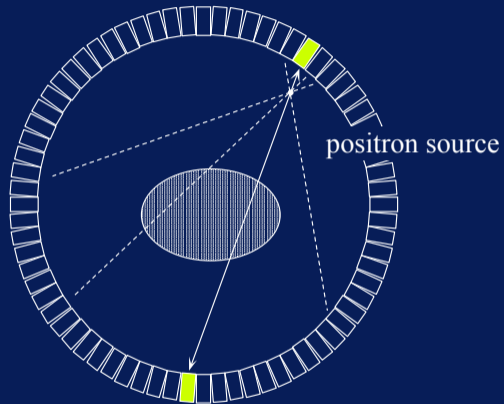

Effect of Misaligned Attenuation Correction

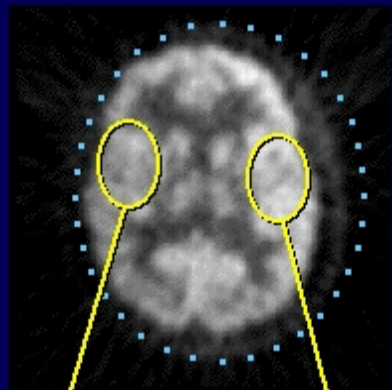
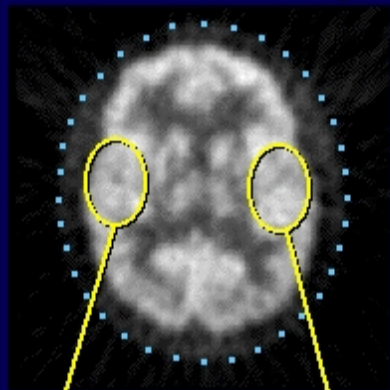

Effect of Incorrect Ellipse Diameter

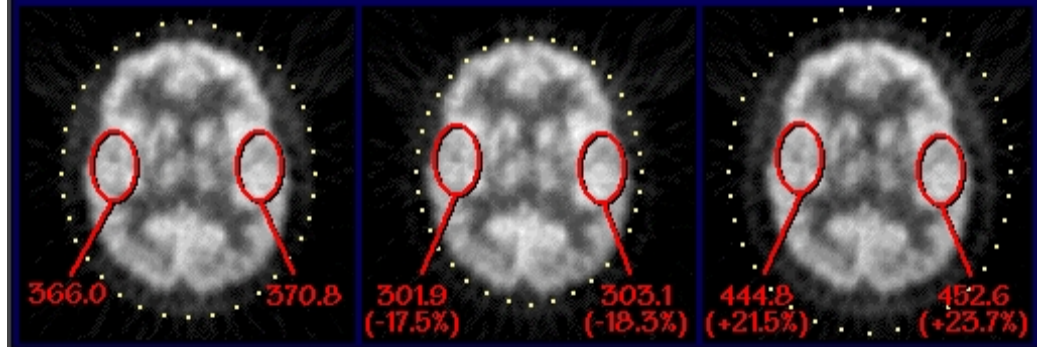

SPECT/CT

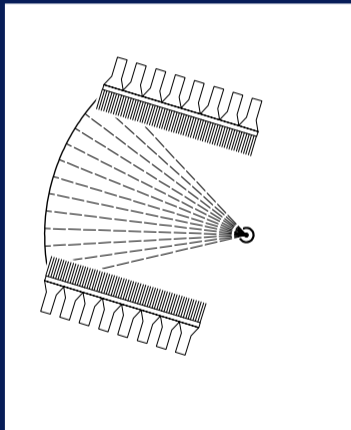

Converting Attenuation Map from Hounsfield to 511 keV attenuation Coefficients

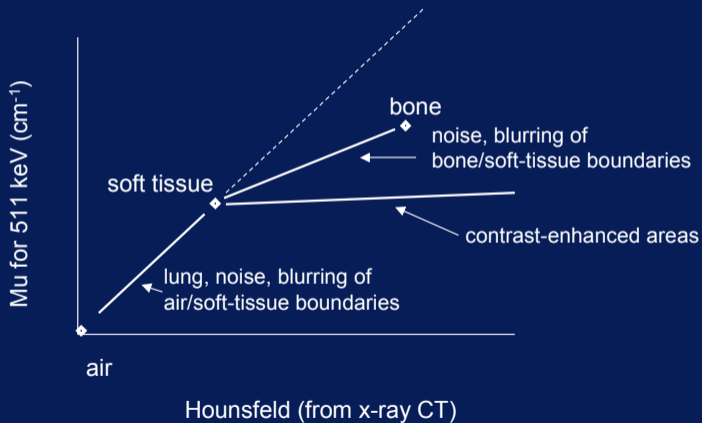

PET — parametry

- ▶ Effective resolution 8 ~ 10 mm
- ▶ Isotropic sampling 3 mm
- ▶ Transaxial FOV 60 cm, axial 10 cm. Increase axial FOV by increasing number of detectors (=higher cost), or shift the patient (=longer time, higher dose).
- ▶ 16 ~ 64 detector planes zachování linearity.

Principles of nuclear imaging

Radioactivity

Gamma camera

SPECT

PET

Principle

Artefacts and corrections

Clinical applications of PET

Kinetic studies

Conclusions

PET, whole body imaging

Tumor has faster metabolism →
contrast agents accumulates there

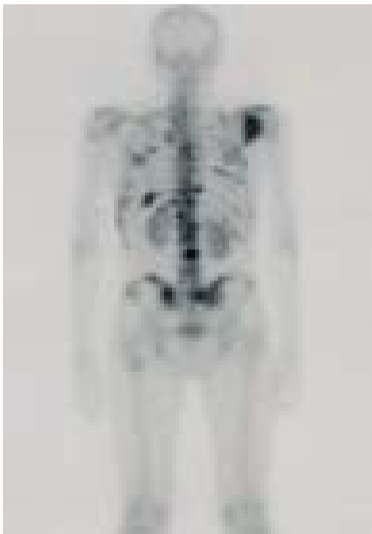

PET + FDG

^{18}F glucose (FDG)

Normal

Lung tumor

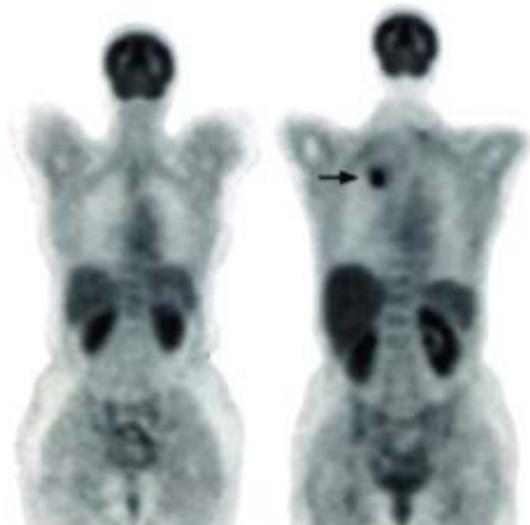

PET + FDG

^{18}F glucose (FDG). Tumor detection.

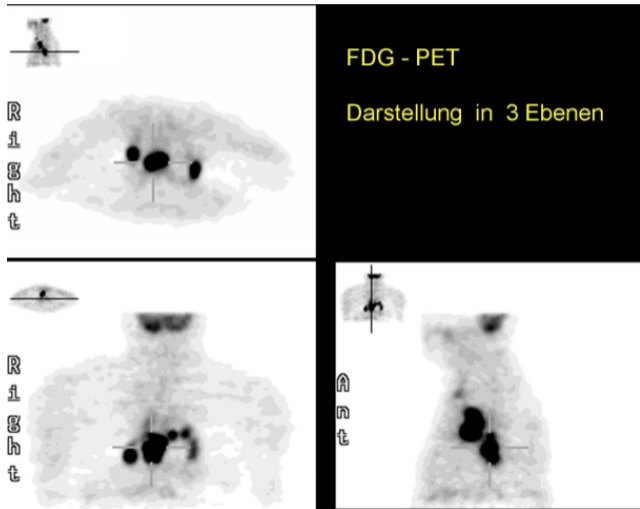

**Brain Tumor
FDG**

6 min, 3D



MRI, T1+C



FDG PET

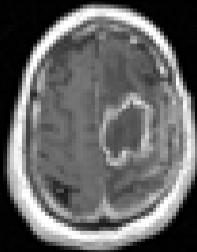

PET. Lung ventilation and perfusion

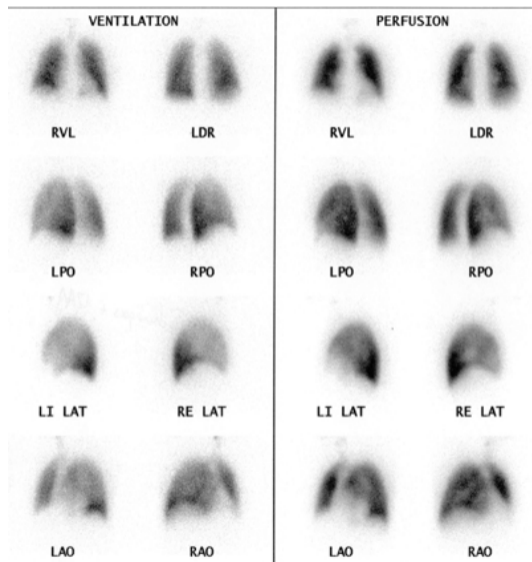

PET, head

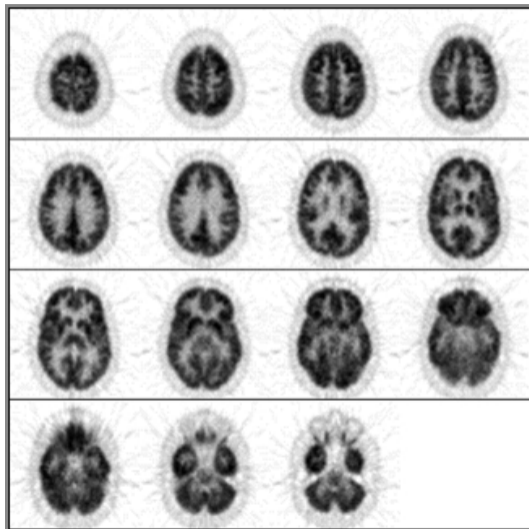

perfusion, glucose metabolism

PET: Applications

Brain imaging

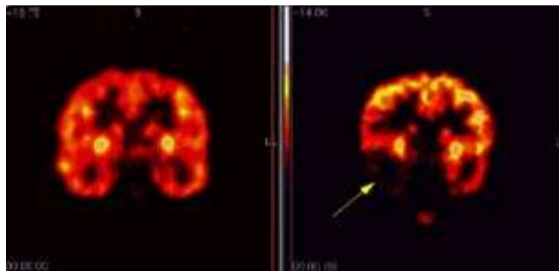

PET, brain

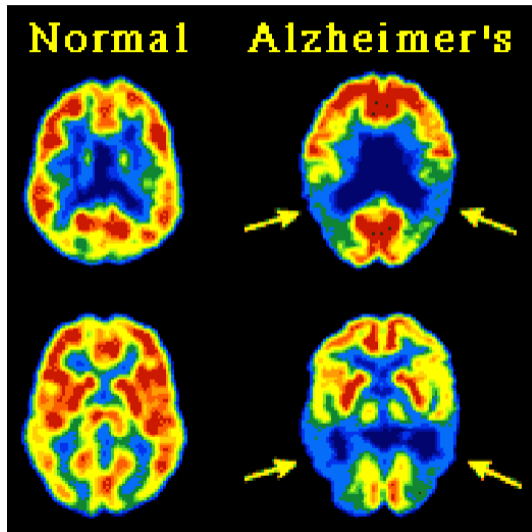

Alzheimer disease

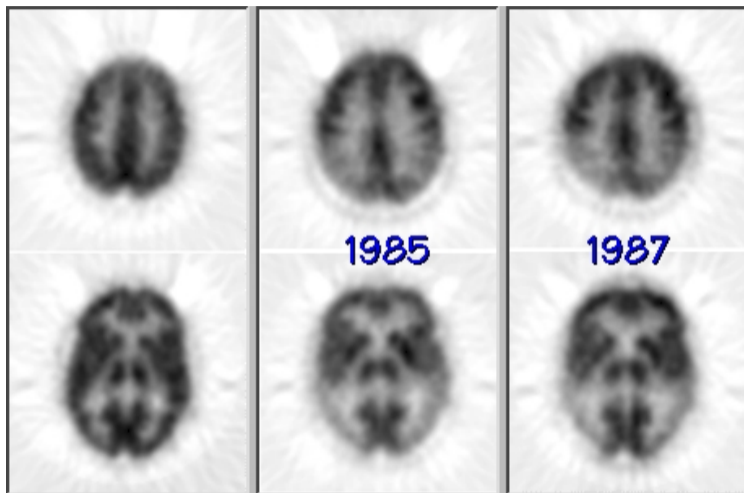

Hypometabolismus.

Parkinson disease

^{18}F – DOPA PET (precursor of neurotransmitter dopamine)

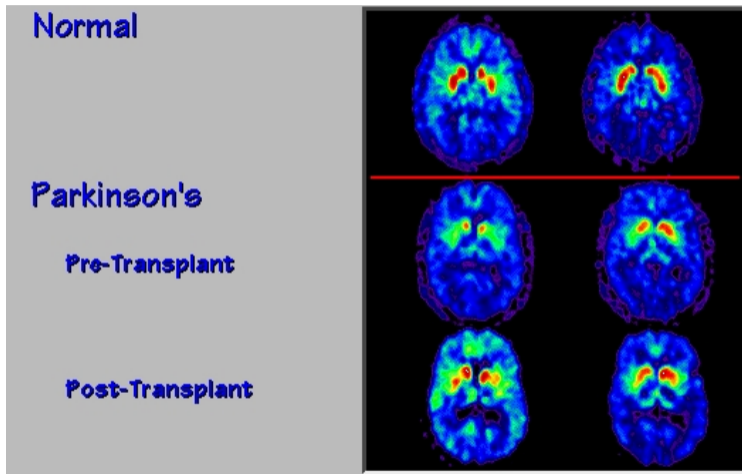

Transplantation of dopamin producing cells.

Brain tumor

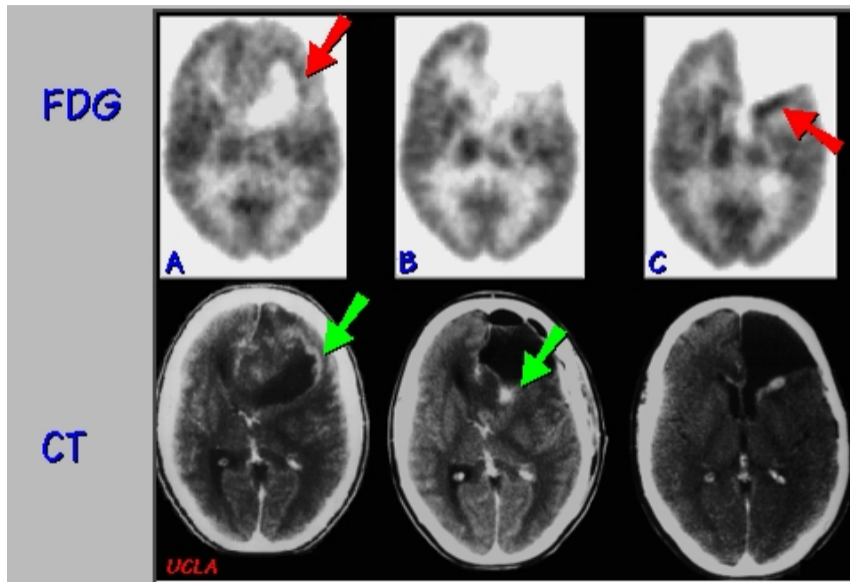

PET, Huntington disease

Reduced glucose metabolism

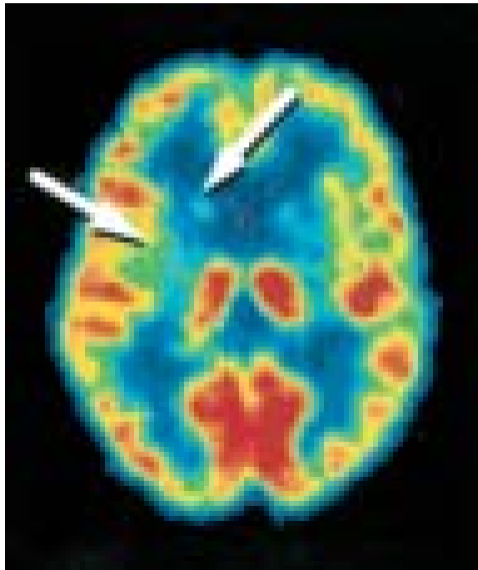

Brain development

FDG

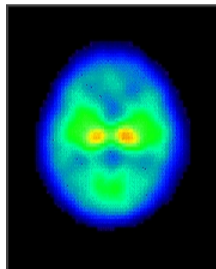

1 month

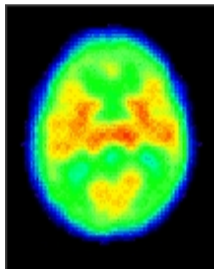

3 months

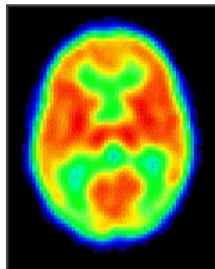

6 months

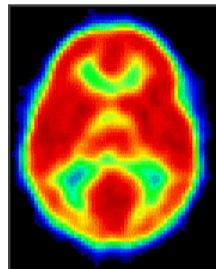

1 year

Fusion of anatomical and functional data

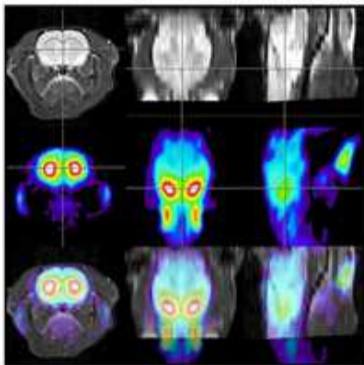
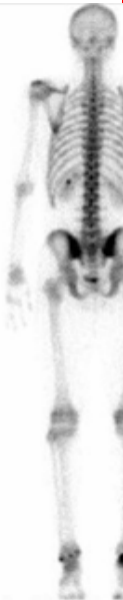

Top: MRI images of a rat brain (axial, multi-slice 256 sq x 16 acquisition, coronal/sagittal views are interpolated)

Center: ^{18}F -labeled specific ligand for the dopamin-transport protein. Compound accumulates in brain areas with a high level of dopamin containing neurons (striatum).

Bottom: Overlay in all three major directions.

Fusion of anatomical and functional data



Fusion
MRI & SPECT

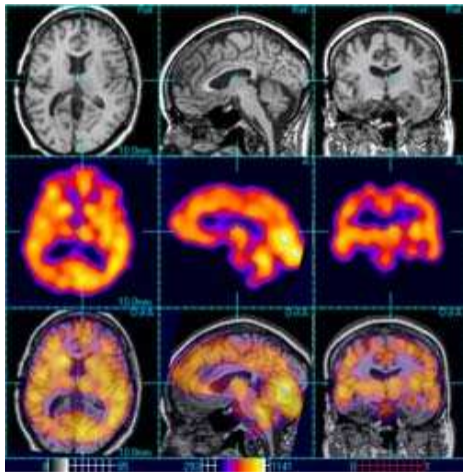

Medical Image Formation Biomedical Image Sciences 2005 - 2006

Fusion of anatomical and functional data

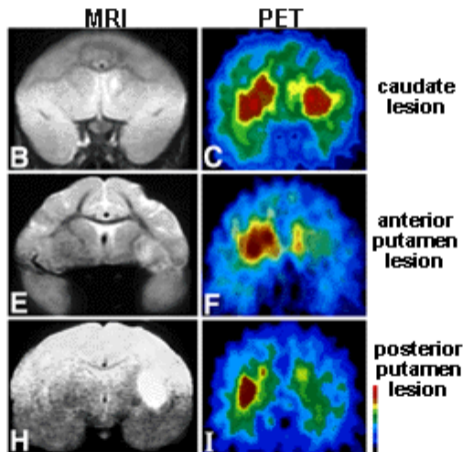
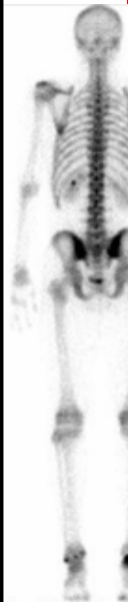

PET: Applications

Functional imaging

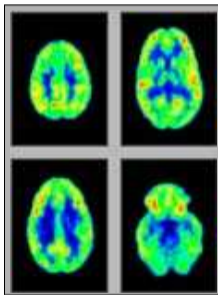

rest

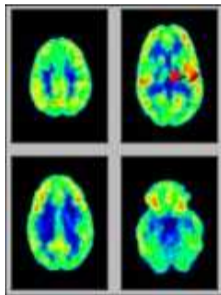

hear

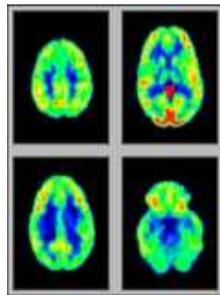

look

Brain at rest

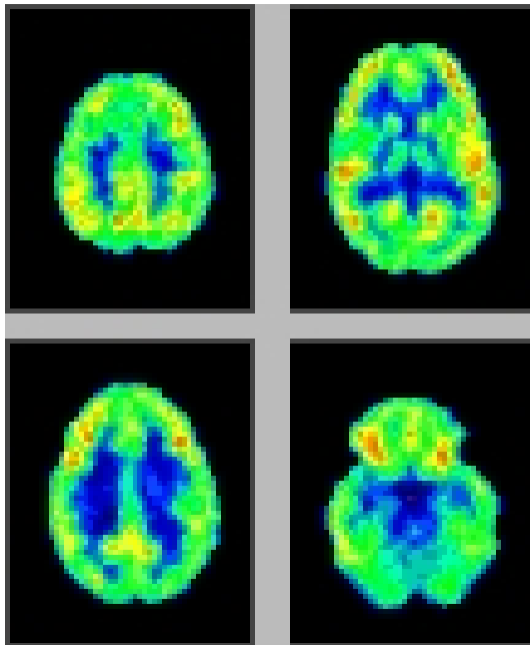

Acoustic stimulation

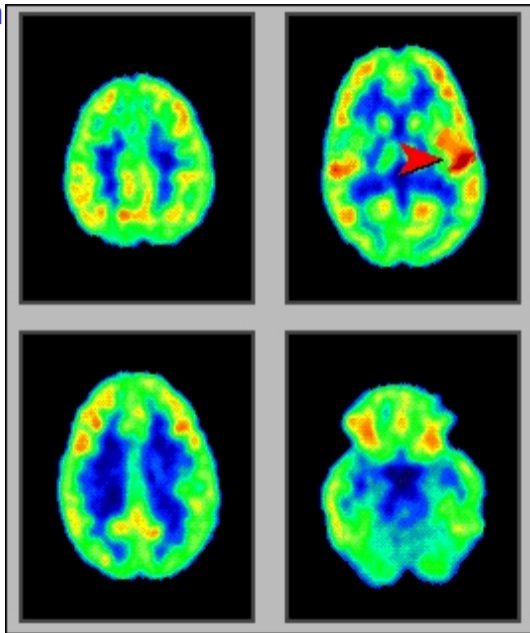

Visual stimulation

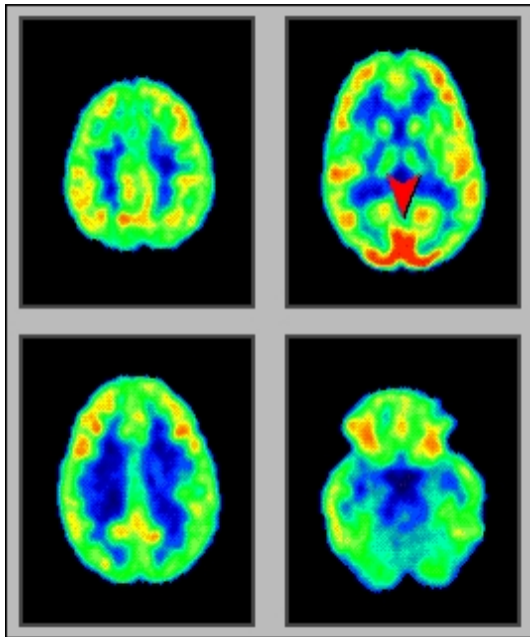

Cognitive activity

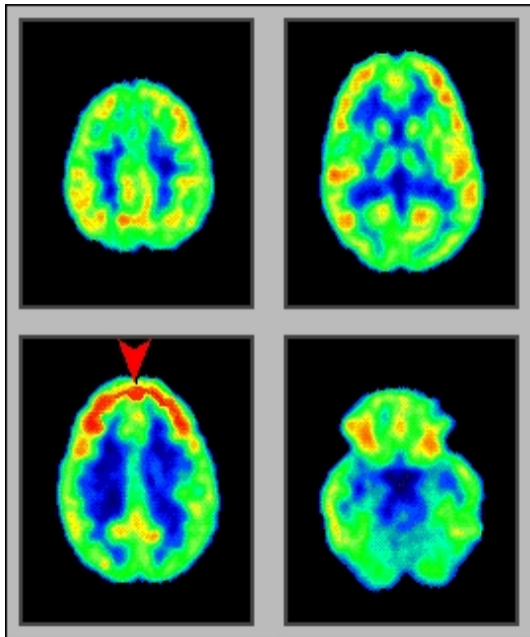

Memory and learning

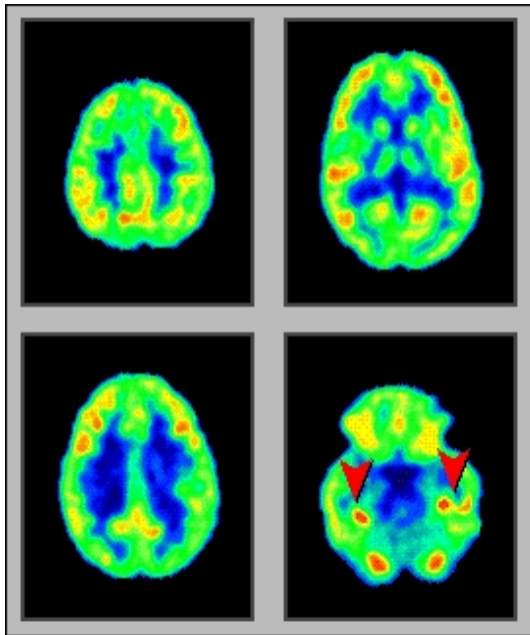

Movement

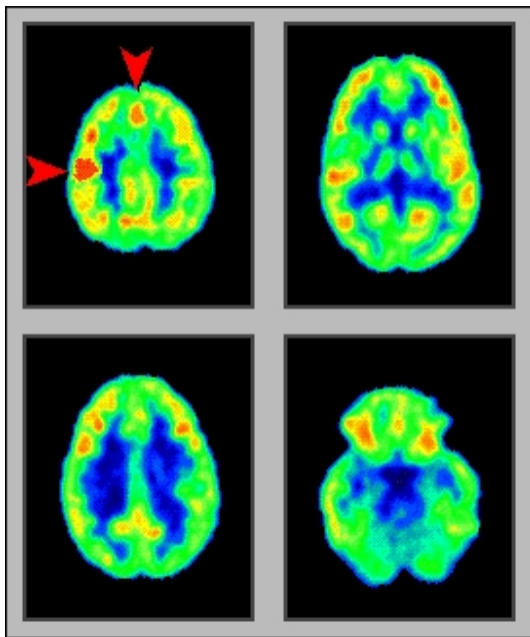

PET: Applications

Cardiac imaging

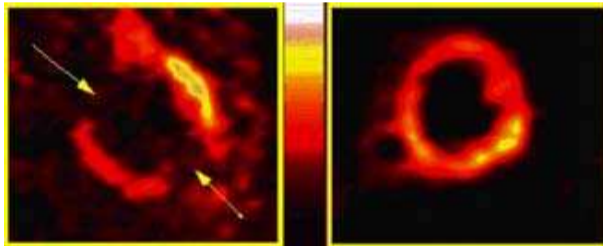

PET, heart

Contrast agent FDG

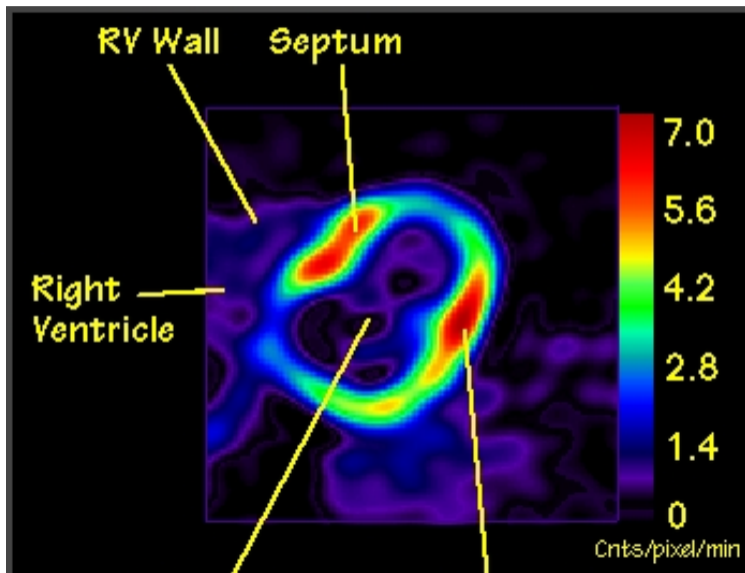

PET, heart

Contrast agent FDG

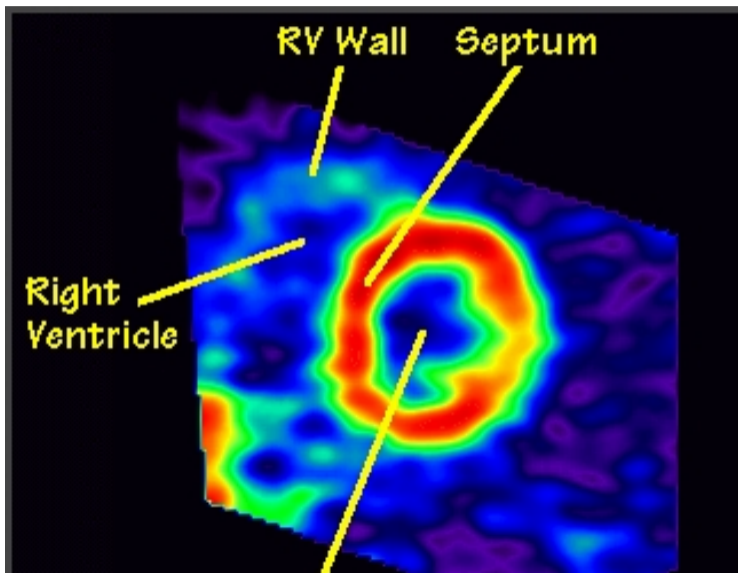

Heart diagnostics

Flow (e.g. NH_3)

Metabolism (e.g. FDG)

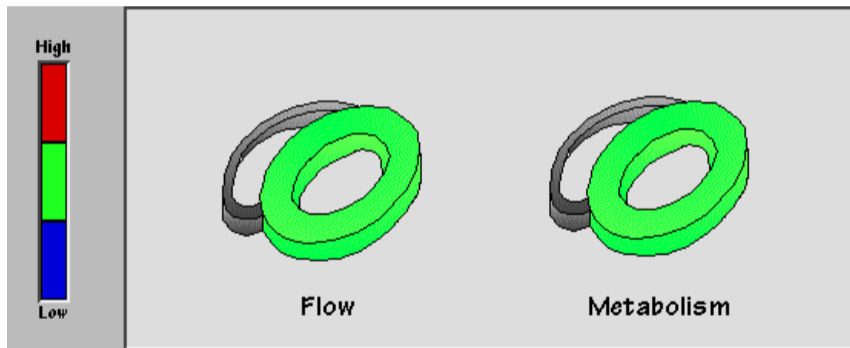

Normal

Heart diagnostics

Flow (e.g. NH_3)

Metabolism (e.g. FDG)

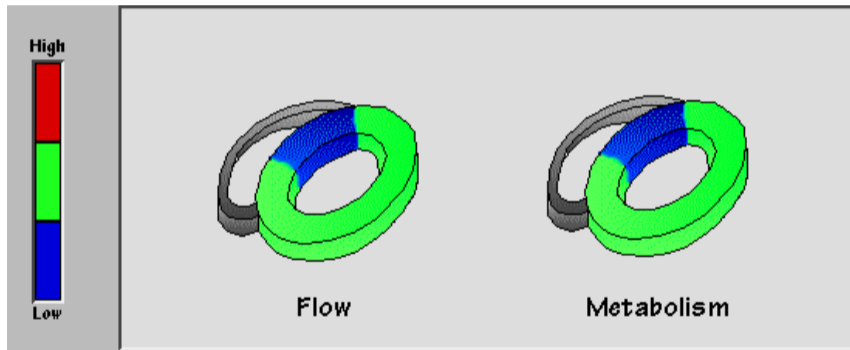

Not functional tissue, treatment not possible.

Heart diagnostics

Flow (e.g. NH_3)

Metabolism (e.g. FDG)

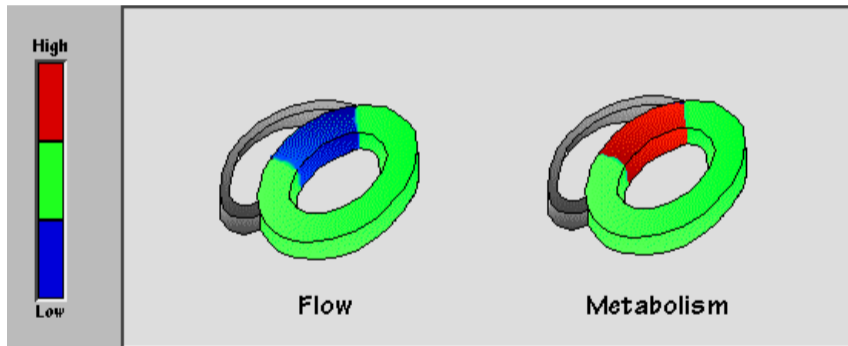

Insufficient perfusion, treatment possible.

Heart diagnostics

Flow (e.g. NH_3)

Metabolism (e.g. FDG)

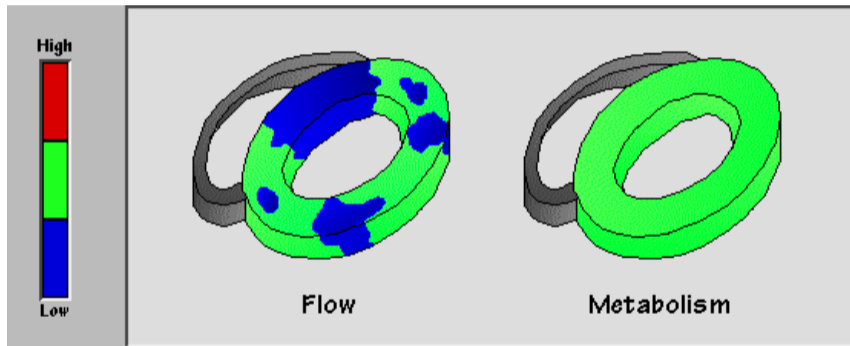

Bad perfusion (ischemic), enlarged myocardium. Treatment possible if the metabolism is normal or increased.

Heart diagnostics

Flow (e.g. NH_3)

Metabolism (e.g. FDG)

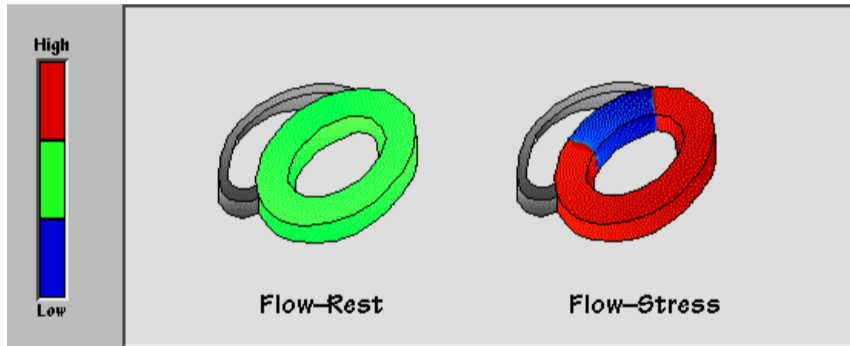

Bad perfusion after load test.

Heart diagnostics

Flow at rest

Flow at load

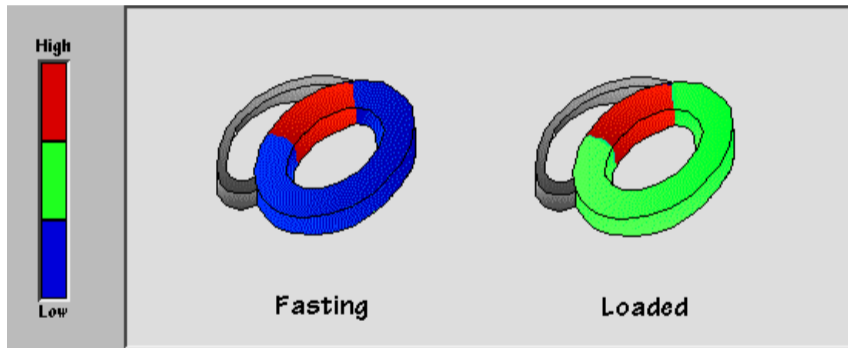

Ischemic myocardium needs more glucose.

Heart diagnostics

Fasting

After glucose is administered

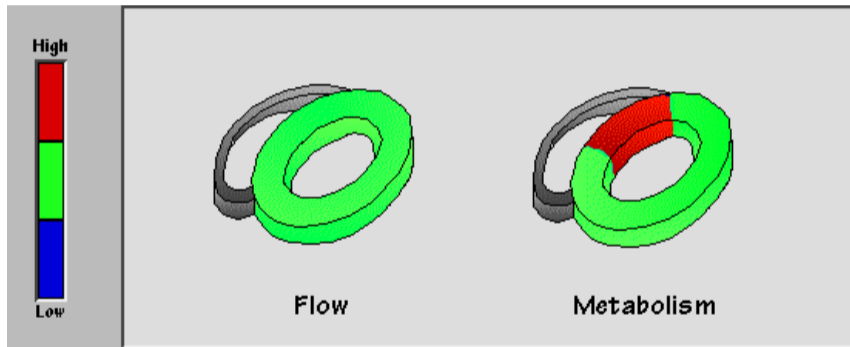

Hibernating myocardium.

Heart diagnostics

Flow (e.g. NH_3)

Metabolism (e.g. FDG)

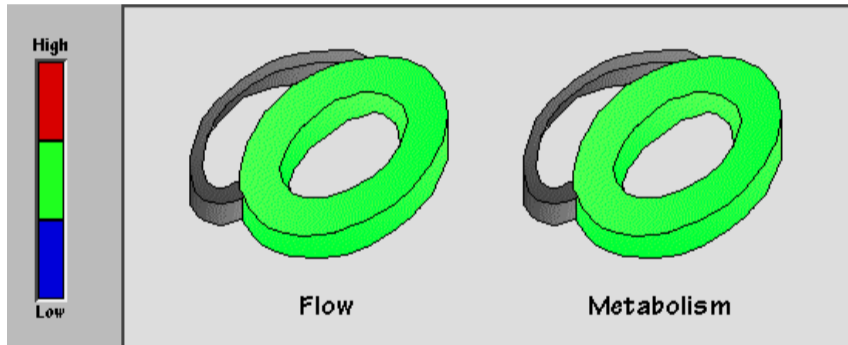

Idiopatically enlarged left ventricle. Only transplantation.

Principles of nuclear imaging

Radioactivity

Gamma camera

SPECT

PET

Principle

Artefacts and corrections

Clinical applications of PET

Kinetic studies

Conclusions

Kinetic study

- ▶ Study the evolution of the radiotracer concentration in time
- ▶ Identify model parameters (time and transport constants)

Kinetic study

- ▶ Study the evolution of the radiotracer concentration in time
- ▶ Identify model parameters (time and transport constants)
- ▶ → Reproducibility

Brain

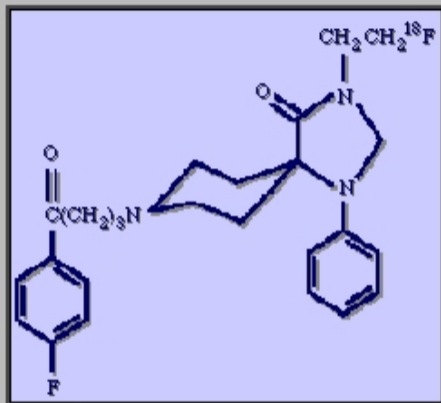

Fluoroethylspiperone

Brain

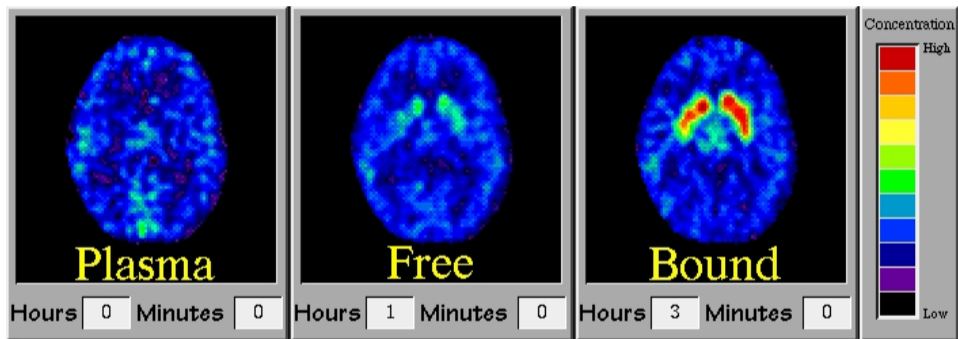

Heart

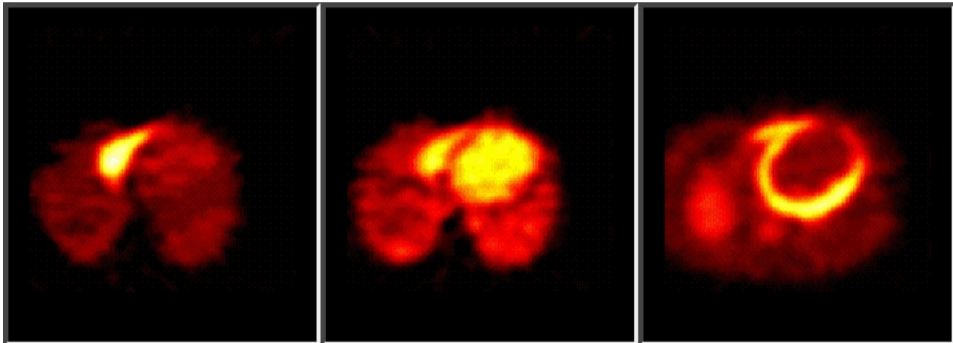

Heart

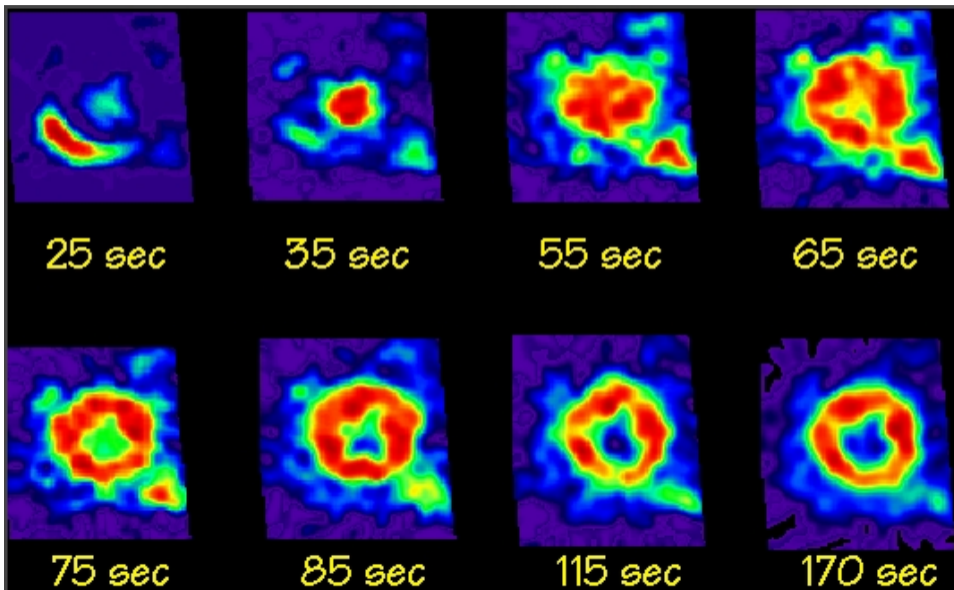

Heart — ROI analysis

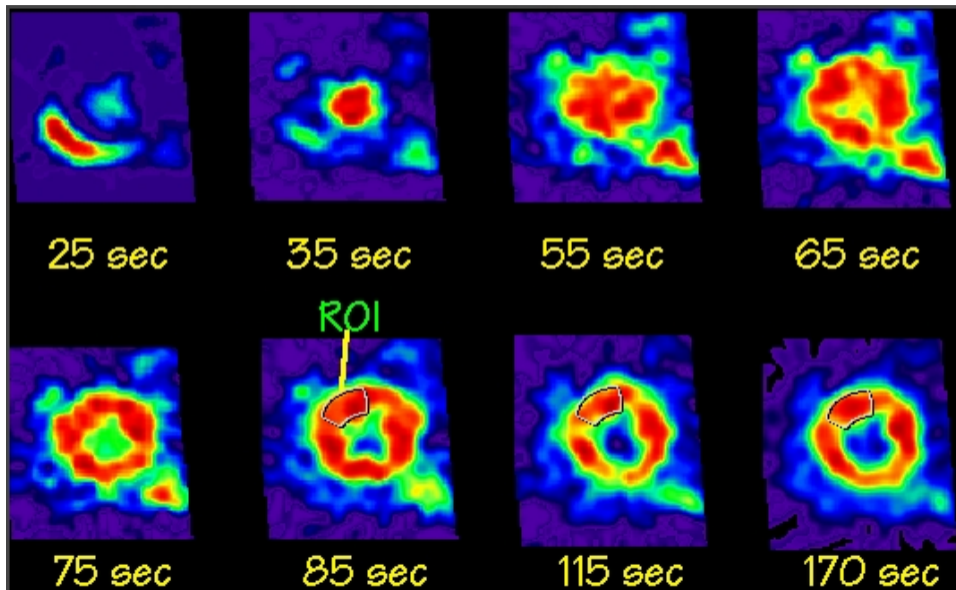

Heart — ROI analysis

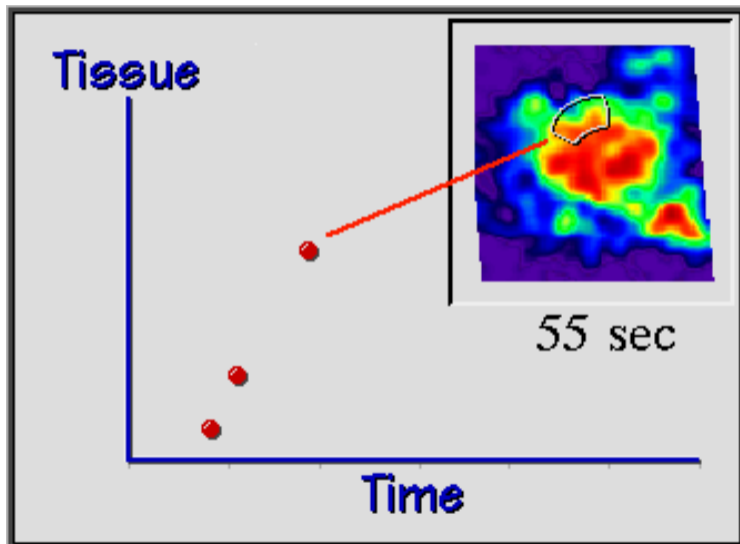

Heart — ROI analysis

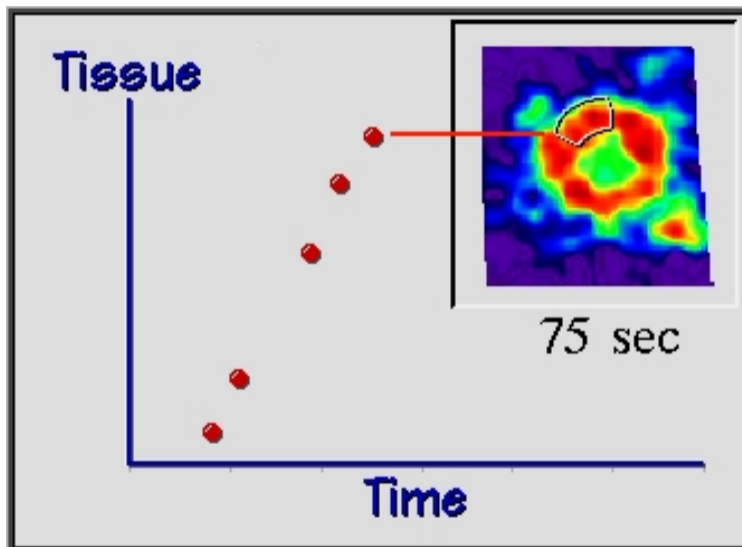

Heart — ROI analysis

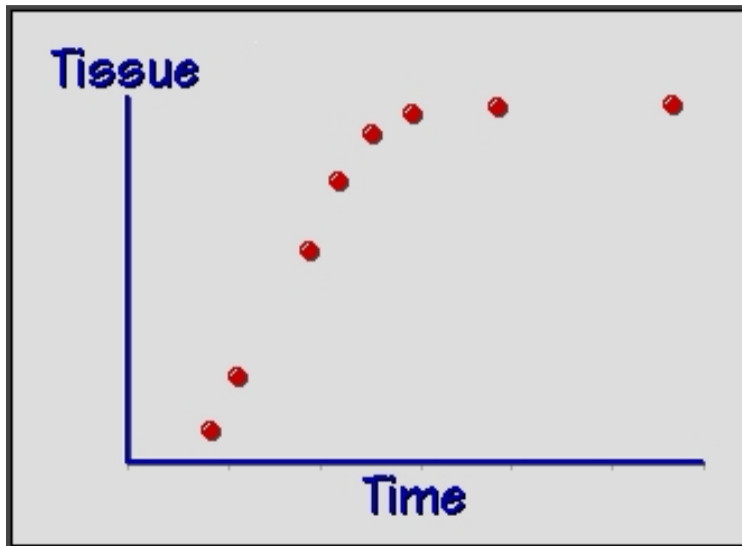

Heart — ROI analysis

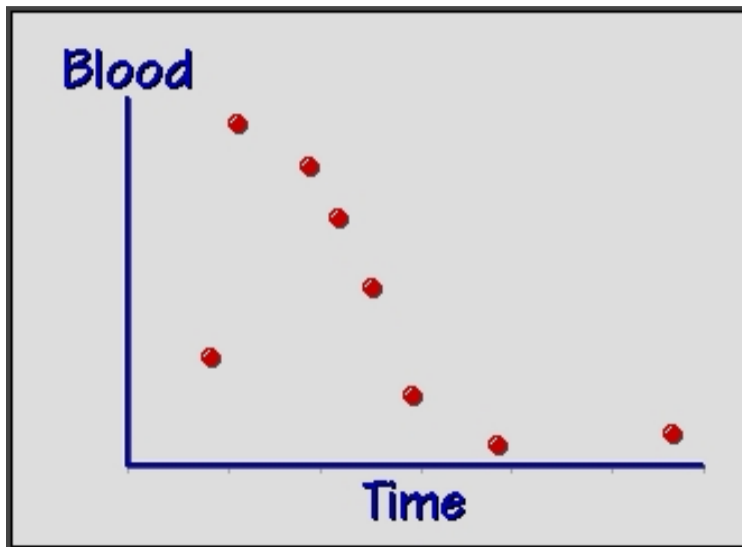

Qualitative × quantitative analysis

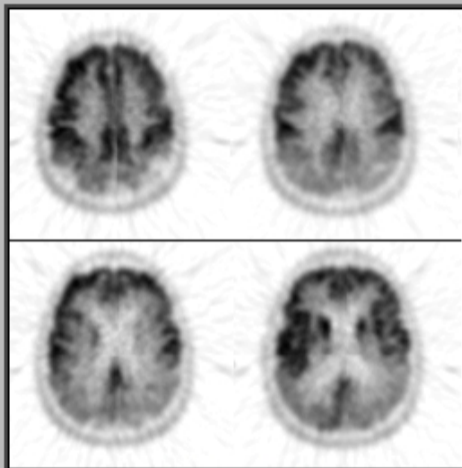

QUALITATIVE

"This pattern is characteristic of Alzheimer's Disease."

Approaches to Image Analysis

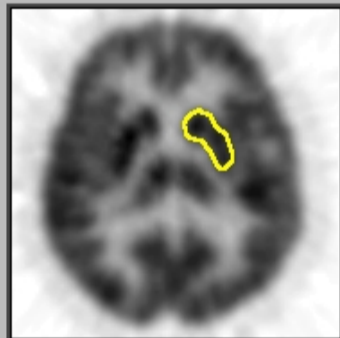

QUANTITATIVE

"Metabolic rate for glucose in this region is 8.37 mg/min/100g tissue"

Normalized radioactivity image

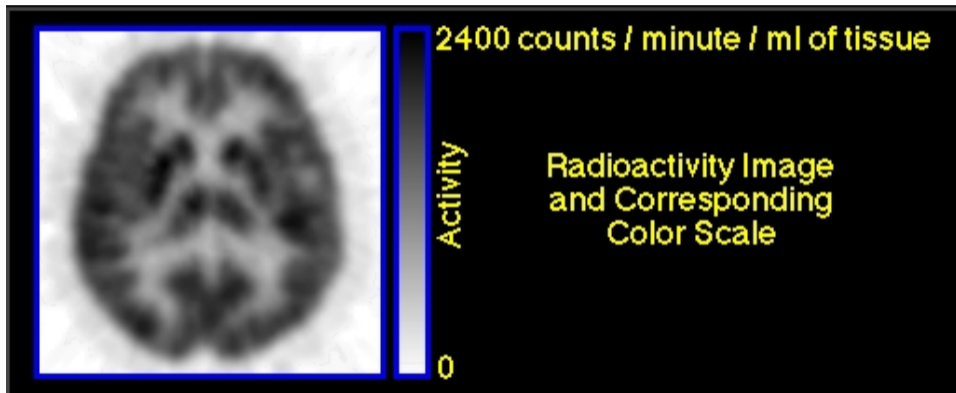

Mean ROI value

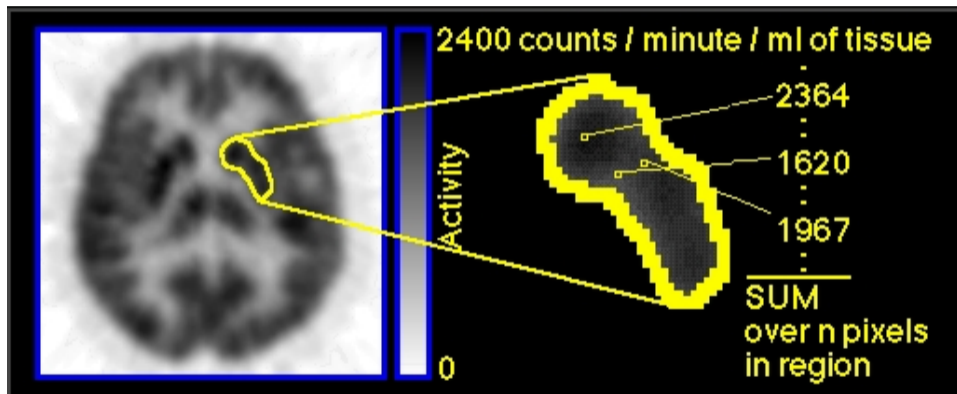

Time-activity ROI curve

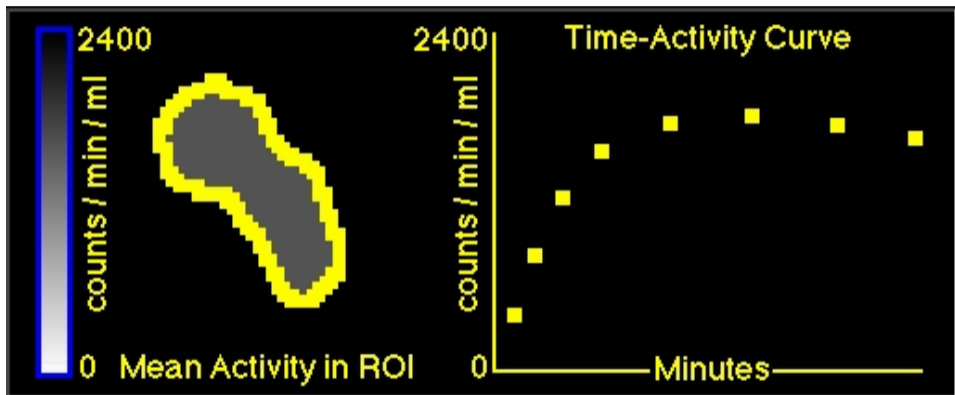

Normalized time-activity ROI curve

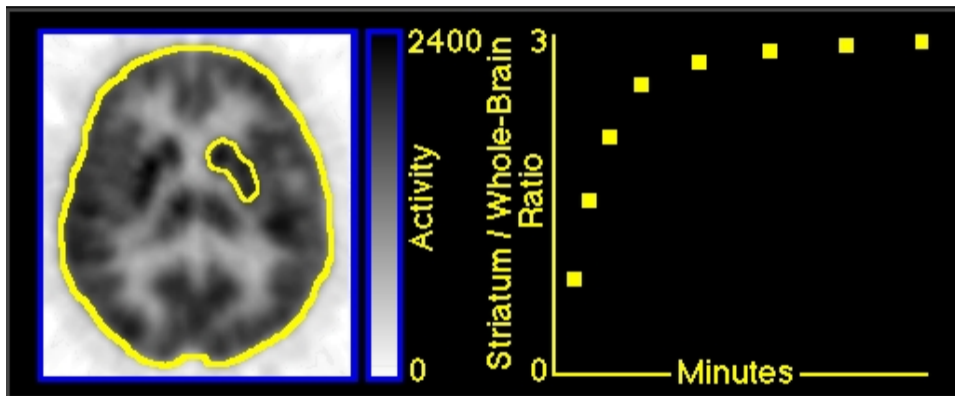

Ratio of regional and total activity.

Tracer modeling of the ROI curve

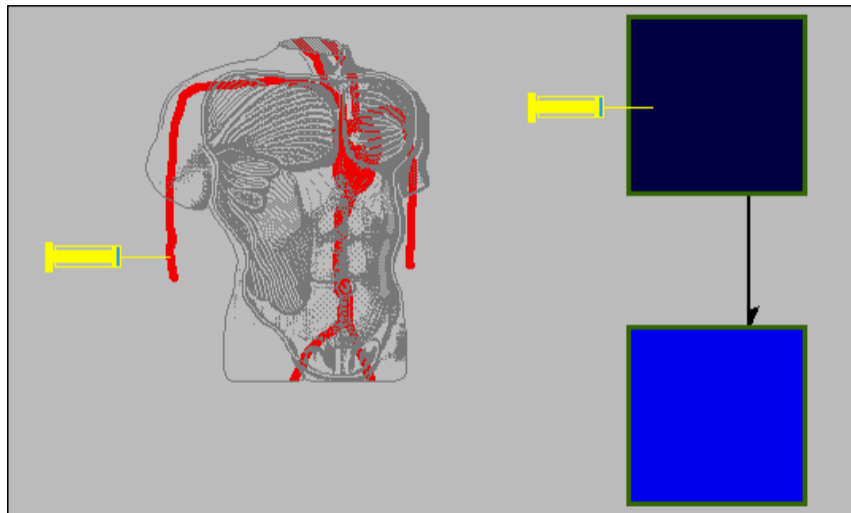

- ▶ Find biophysical model parameters — blood flow, concentrations, diffusion coefficients.

Tracer modeling of the ROI curve

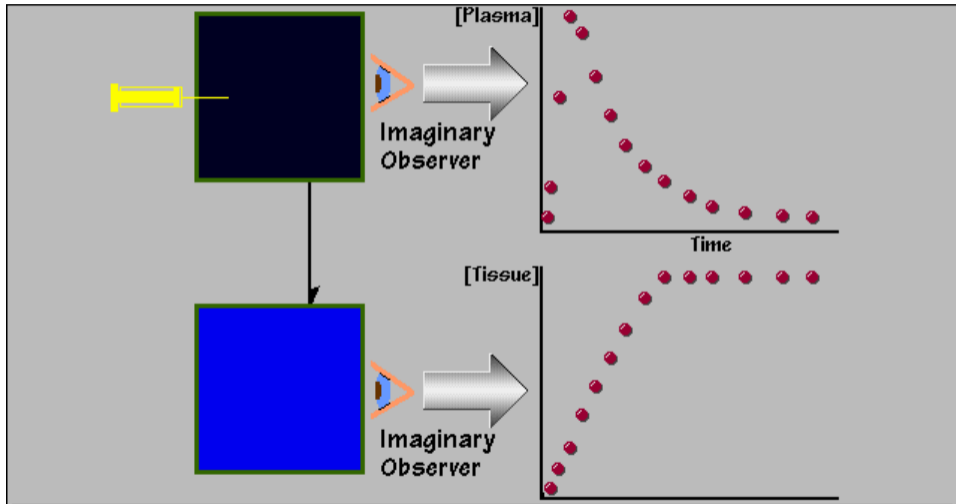

Tracer modeling of the ROI curve

Iteration #: 3

Chi-Square: 0.6879142

Parameter	Estimate	Standard Error
-----------	----------	----------------

k1	0.1019	0.01735
----	--------	---------

k2	0.1326	0.02242
----	--------	---------

k3	0.06548	0.006839
----	---------	----------

Convergence has occurred.

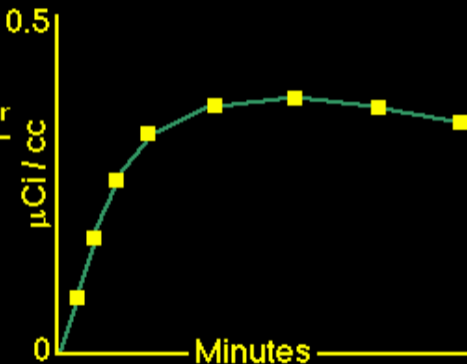

Nuclear imaging — summary

- + Functional imaging; intensity of the metabolic processes
- + Targeted and specific imaging, perfusion, oncology
- Radiation dose
- Manufacturing radiopharmaceuticals, expensive
- Only partial anatomy information
- Bad spatial resolution