

# Introduction to Robotics

Jan Faigl

Department of Computer Science

Faculty of Electrical Engineering  
Czech Technical University in Prague

Lecture 01

**B4M36UIR – Artificial Intelligence in Robotics**

## Part I

### Part 1 – Course Organization

## Overview of the Lecture

- Part 1 – Course Organization
  - Course Goals
  - Means of Achieving the Course Goals
  - Evaluation and Exam
- Part 2 – Introduction to Robotics
  - Robots and Robotics
  - Challenges in Robotics
  - What is a Robot?
  - Locomotion

## Course and Lecturers

### B4M36UIR – Artificial Intelligence in Robotics

- <https://cw.fel.cvut.cz/wiki/courses/b4m36uir/>
- Department of Computer Science – <http://cs.fel.cvut.cz>
- Artificial Intelligence Center (AIC) – <http://aic.fel.cvut.cz>
- Lecturers

doc. Ing. **Jan Faigl**, Ph.D.

- Center for Robotics and Autonomous Systems (CRAS)  
<http://robotics.fel.cvut.cz>
- Computational Robotics Laboratory (ComRob)  
<http://comrob.fel.cvut.cz>



Mgr. **Branislav Bořanský**, Ph.D.

- Head of Game Theory (GT) research group
- **Adversarial planning**, Sequential Games, Dynamic Games, Stackelberg Equilibrium, Equilibrium Computation



## Course Goals

- **Master** (yourself) with applying AI methods in robotic tasks  
*Labs, homeworks, exam*
- **Become** familiar with the notion of intelligent robotics and autonomous systems
- **Acquire** knowledge of robotic data collection planning
- **Acquire experience** on combining approaches in autonomous robot control programs  
*Integration of existing algorithms (implementation) in to mission planning software and robot control program*
- **Experience** solution of robotic problems  
*Your own experience!*

## Resources and Literature

### Textbooks

- Introduction to AI Robotics, *Robin R. Murphy*, MIT Press, 2000, ISBN 978-0262133838  
*First lectures for the background and context*
- The Robotics Primer, *Maja J. Mataric*, MIT Press, 2007, ISBN 978-0262633543  
*First lectures for the background and context*
- Planning Algorithms, *Steven M. LaValle*, Cambridge University Press, 2006.  
<http://planning.cs.uiuc.edu>

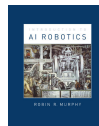

- **Lectures** – “comments” on the textbooks, slides, and **your notes**
- **Laboratory Exercises** – labs’ tasks and homeworks
- **Selected research papers** – further specified during the course

## Course Organization and Evaluation

- B4M36UIR and BE4M36UIR – Artificial intelligence in robotics
- Extent of teaching: 2(lec)+2(lab);
- Completion: Z,ZK; Credits: 6;  
*Z – ungraded assessment, ZK – exam*
- Ongoing work during the semester – labs’ tasks and homeworks
- Exam: test and exam  
*Be able to independently work with the computer in the lab (class room)*
- Attendance to labs and successful evaluation of homeworks

## Further Books 1/2

- Principles of Robot Motion: Theory, Algorithms, and Implementations, *H. Choset, K. M. Lynch, S. Hutchinson, G. Kantor, W. Burgard, L. E. Kavraki and S. Thrun*, MIT Press, Boston, 2005.
- Introduction to Autonomous Mobile Robots, 2nd Edition, *Roland Siegwart, Illah R. Nourbakhsh, and Davide Scaramuzza*, MIT Press, 2011, ISBN 978-0521692120
- Computational Principles of Mobile Robotics, *Gregory Dudek and Michael Jenkin*, Cambridge University Press, 2010, ISBN 978-0262015356

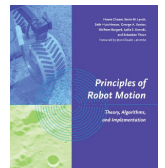

## Further Books 2/2

 **Robot Motion Planning and Control**, *Jean-Paul Laumond*, Lectures Notes in Control and Information Sciences, 2009.  
<http://homepages.laas.fr/jpl/book.html>



 **Probabilistic Robotics**, *Sebastian Thrun, Wolfram Burgard, Dieter Fox*, MIT Press, 2005, ISBN 978-0262201629  
<http://www.probablistic-robotics.org/>

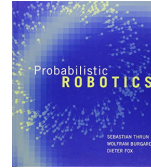

 **Robotics, Vision and Control: Fundamental Algorithms in MATLAB**, *Peter Corke*, Springer, 2011, ISBN 978-3642201431  
<http://www.petercorke.com/RVC1/>

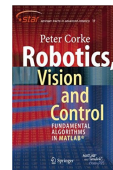

## Teachers

### ■ Ing. Petr Čížek



- Hexapod walking robots – design and motion control
- Vision based Simultaneous Location and Mapping (SLAM)
- Image processing and robot control on FPGA
- Motion planning and terrain traversability assessment

## Lectures – Winter Semester (WS) Academic Year 2017/2018

- Schedule for the academic year 2017/2018  
<http://www.fel.cvut.cz/en/education/calendar.html>
- Lectures:
  - Karlovo náměstí, Room No. KN:E-126, Monday, 9:15–10:45
- 14 teaching weeks
- New Year's Day – 1.1.2018 (Monday)

*13 lectures*

## Communicating Any Issues Related to the Course

- Ask the lab teacher or the lecturer
- Use e-mail for communication
  - Use your **faculty e-mail**
  - **Put UIR or B4M36UIR, BE4M36UIR to the subject of your message**
  - Send copy (Cc) to lecturer/teacher

## Computers and Development Tools

- Network boot with home directories (NFS v4)  
*Data transfer and file synchronizations – ownCloud, SSH, FTP, USB*
- Python or/and C/C++ (**gcc** or **clang**)
- V-REP robotic simulator  
<http://www.coppeliarobotics.com/>
- Open Motion Planning Library (OMPL)  
<http://ompl.kavrakilab.org/>
- Sources and libraries provided by **Computational Robotics Laboratory**
- Any other open source libraries
- Gitlab FEL – <https://gitlab.fel.cvut.cz/>
- FEL Google Account – access to Google Apps for Education  
See <http://google-apps.fel.cvut.cz/>
- Information resources (IEEE Xplore, ACM, Science Direct, Springer Link)
  - *IEEE Robotics and Automation Letters (RA-L), IEEE Transactions on Robotics (T-RO), International Journal of Robotics Research (IJRR), Journal of Field Robotics (JFR), Robotics and Autonomous Robots (RAS), Autonomous Robots (AuRo), etc.*

## Course Evaluation

Points	Maximum Points	Required Minimum Points
Lab tasks	20	10
Homeworks	30	20
Exam test	30	15
Exam	20	10
<b>Total</b>	<b>100 points</b>	<b>55 points is E!</b>

- **30** points from the semester are required for awarding ungraded assessment
- The course can be passed with **ungraded assessment** and **exam**
- All homeworks must be submitted and pass the evaluation

## Homeworks

- TBD

## Grading Scale

Grade	Points	Mark	Evaluation
<b>A</b>	$\geq 90$	1	Excellent
<b>B</b>	80–89	1,5	Very Good
<b>C</b>	70–79	2	Good
<b>D</b>	60–69	2,5	Satisfactory
<b>E</b>	50–59	3	Sufficient
<b>F</b>	$<50$	4	Fail

## Overview of the Lectures

1. Course information, Introduction to (AI) Robotics and Robotic Paradigms
2. Navigation and path planning
3. Path Planning - Grid based methods
4. Path Planning - Grid based methods
5. Motion Planning - Sampling-based methods
6. Motion Planning - Randomized Sampling-based methods
7. Robotic information gathering and data collection planning
8. Data collection planning and multi-goal path planning problems
9. Robotic exploration and multi-robot exploration
10. Data collection planning with curvature-constrained vehicles (DTSP(N) and DOP(N))
11. Game Theory in Robotics
12. Game Theory in Robotics
13. Game Theory in Robotics

## What is Understood as Robot?

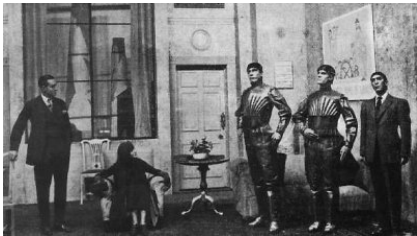

*Rossum's Universal Robots (R.U.R)*



*Industrial robots*



*Cyberdyne T-800*

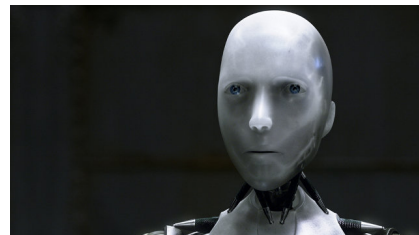

*NS-5 (Sonny)*

*Artificial Intelligence (AI) is probably most typical understand as intelligent robot*

## Part II

### Part 2 – Introduction to Robotics

## Intelligent Robots

- React to the environment – sensing
  - Adapt to the current conditions
  - Make decision and new goals
- E.g., in robotic exploration*
- Even though they are autonomous systems, the behaviour is relatively well defined
  - Adaptation and ability to solve complex problems are implemented as algorithms and techniques of **Artificial Intelligence**

*In addition to mechanical and electrical design, robot control, sensing, etc.*

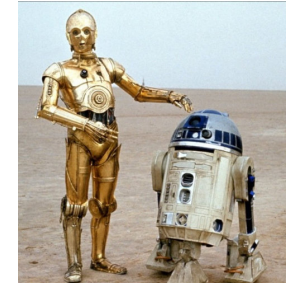



## Stationary vs Mobile Robots

- Robots can be categorized into two main groups



Stationary (industrial) robots



Mobile robots

- Stationary robots – defined (limited) working space
  - Even stationary robots need an efficient motion, and thus **motion planning tasks** can be a challenging problem
- Mobile robots – it can move, and therefore, it is necessary to address the problem of **navigation**

## Types of Mobile Robots

- Regarding the environment: ground, underground, aerial, surface, and underwater vehicles
- Based on the locomotion: wheeled, tracked, legged, modular

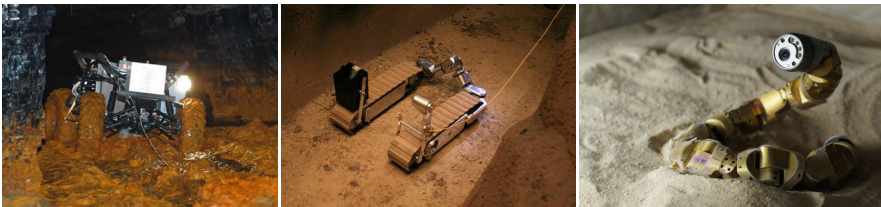

## Stationary Robots

- Conventional robots need separated and human inaccessible working space because of safety reasons
- Cooperating robots share the working space with humans

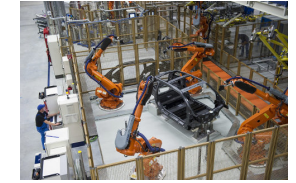

## Challenges in Robotics

- Autonomous vehicles – cars, delivers, etc
- Consumable robots – toys, vacuum cleaner, lawn mover, pool cleaner
- Robotic companions
- Search and rescue missions
- Extraterrestrial exploration
- Robotic Surgery
- Multi-robot coordination

In addition to other technological challenges, new efficient AI algorithms have to be developed to address the nowadays and future challenges

## Robotic Surgery

### ■ Evolution of Laparoscopic Surgery

Complex operations with shorter postoperative recovery

### ■ Precise robotic manipulators and teleoperated surgical robotic systems

### ■ Further step is automation of a surgical procedures

*One of the main main challenges is planning and navigation in tissue*

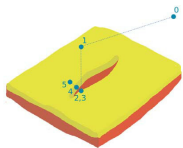
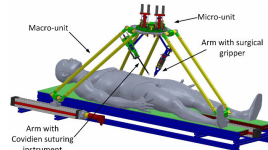
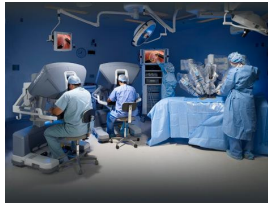

Model tkáně



Robotic Arm of the Da Vinci Surgical System



Surgical droid 2-1B

## Robotics in B4M36UIR

### ■ Fundamental problems related to motion planning and mission planning with mobile robots

### ■ The discussed motion planning methods are general and applicable also into other domains and different robotic platforms including stationary robotic arms

### ■ Robotics is interdisciplinary field

- Electrical, mechanical, control, and computer engineering
- **Computer science** such as machine learning, artificial intelligence, computational intelligence, machine perception, etc.
- Human-Robot interaction and cognitive robotics is also related to psychology, brain-robot interfaces to Neuroscience, robotic surgery to medicine, etc.

*In B4M36UIR, we will touch a small portion of the whole field, mostly related to motion planning and mission planning that can be “encapsulated” as robotic information gathering*

## Artificial Intelligence and Robotics

### ■ Artificial Intelligence (AI) field originates in 1956 with the summary that a intelligent machine needs:

- Internal models of the world
- Search through possible solutions
- Planning and reasoning to solve problems
- Symbolic representation of information
- Hierarchical system organization
- Sequential program execution

M. Mataric, Robotic Primer

### ■ AI-inspired robot – Shakey

Artificial Intelligence laboratory of Stanford Research Institute (1966–1972)

### ■ Shakey – perception, geometrical map building, planning, and acting – early AI-inspired robotics purely deliberative control

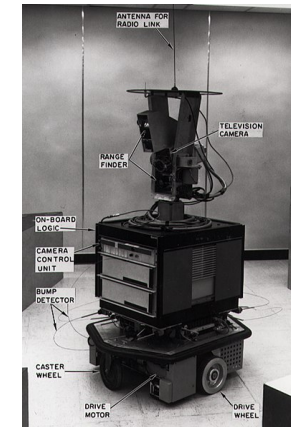

## What is a Robot?

A robot is an autonomous system which exists in the physical world, can sense its environment, and can act on it to achieve some goals

- The robot has a physical body in the physical world – **embodiment**
- The robot has **sensors** and it can **sense/perceive** its environment
- A robot has effectors and actuators – it can **act** in the environment
- A robot has **controller** which allows it to be **autonomous**

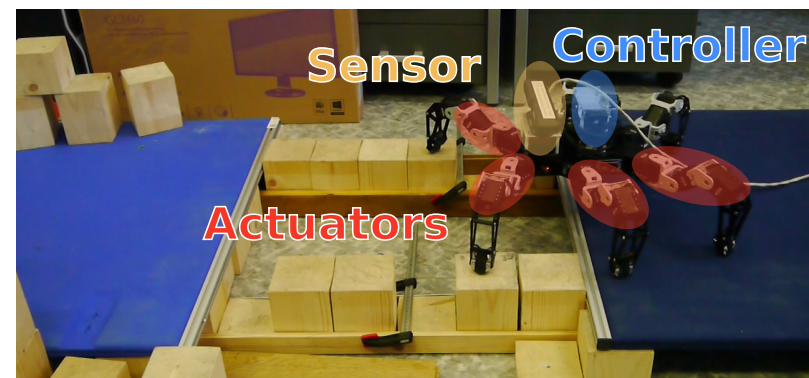



## Embodiment

- The robot body allows the robot to act in the physical world  
*E.g., to go, to move objects, etc.*
- Software agent is not a robot
- Embodied robot is under the same physical laws as other objects
  - Cannot change shape or size arbitrarily
  - It must use actuators to move
  - It needs energy
  - It takes some time to speed up and slow down
- Embodied robot has to be aware of other bodies in the world
  - Be aware of possible collisions
- The robot body influences how the robot can move  
*Notice, faster robots look smarter*

## Sensors

- **Proprioceptive sensors** – measure internal status, e.g., encoders, inclinometer, inertial navigation systems (INS), compass, but also Global Positioning System (GPS)
- **Exteroceptive (proximity) sensors** – measure objects relative to the robot
- **Contact sensors** – e.g., mechanical switches, physical contact sensors that measure the interaction forces and torques, tactile sensors etc.
- **Range sensors** – measure the distance to objects, e.g., sonars, lasers, IR, RF, time-of-flight
- **Vision sensors** – complex sensing process that involves extraction, characterization, and information interpretation from images



## Sensing / Perception

- Sensors are devices that enable a robot to perceive its physical environment to get information about itself and its surroundings
- Exteroceptive sensors and proprioceptive sensors
- Sensing allows the robot to know its **state**
- State can be **observable**, **partially observable**, or **unobservable**
  - State can be **discrete** (e.g., on/off, up/down, colors) or **continuous** (velocity)
  - **State space** consists of all possible states which the system can be
    - **space** refers to all possible values
  - **External state** – the state of the world as robot can sense it
  - **Internal state** – the state of the robot as the robot can perceive it  
*E.g., remaining battery*



## Action

- **Effectors** enables a robot to take an action
  - They use underlying mechanism such as muscles and motors called **actuators**
- Effectors and actuators provides two main types of activities
  - **Locomotion** – moving around  
*Mobile robotics – robots that move around*
  - **Manipulation** – handling objects  
*Robotic arms*
- Locomotion mechanisms – wheels, legs, modular robots, but also propellers etc.



*With more and more complex robots, a separation between mobile and manipulator robots is less strict and robots combine mobility and manipulation*



## Effectors and Actuators

- **Effector** – any device on a robot that has an effect on the environment
- **Actuator** – a mechanisms that allows the effector to execute an action or movement, e.g., motors, pneumatics, chemically reactive materials, etc.
- Electric motors – Direct-Current (DC) motors, gears,
  - **Servo motors** – can turn their shaft to a specific position  
DC motor + gear reduction + position sensor + electronic circuit to control the motor

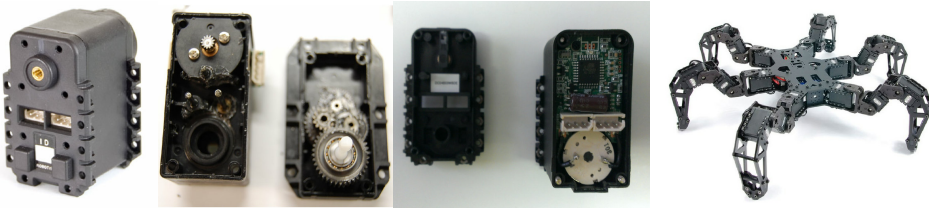

Hexapod with 3 servo motors (joints) per each leg has 18 servo motors in total

## DOF vs CDOF

- If a vehicle moves on a surface, e.g., a car, it actually moves in 2D
- The body is at the position  $(x, y) \in \mathbb{R}^2$  with an orientation  $\theta \in \mathbb{S}^1$
- A car in a plane has  $\text{DOF} = 3, (x, y, \theta)$  but  $\text{CDOF}=2, (v, \varphi)$

*Only forward/reverse direction and steering angle can be controlled*

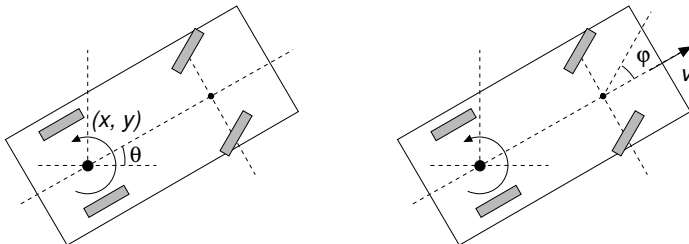

*That is why a parallel parking is difficult*

- A car cannot move in an arbitrary direction, but 2 CDOF can get car to any position and orientation in 2D
- To get to a position, the car follows a **continuous trajectory (path)**, but with **discontinuous velocity**

*Uncontrollable DOF makes the movement more complicated*

## Degrees of Freedom (DOF)

- **Degree of Freedom (DOF)** is the minimal required number of independent parameters to completely specify the motion of a mechanical system  
*It defines how the robot can move*

In 3D space, a body has usually 6 DOF (by convention)

- **Translational DOF** –  $x, y, z$
- **Rotational DOF** – roll, pitch, and yaw

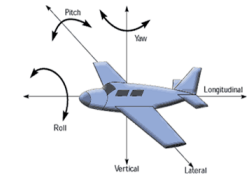

- **Controllable DOF (CDOF)** – the number of the DOF that are controllable, i.e., a robot has an actuator for such a DOF

## Ratio of CDOF to the Total DOF

- The ratio of Controllable DOF (CDOF) to the Total DOF (TDOF) represents how easy is to control the robot movement
- **Holonomic** (CDOF=TDOF, the ratio is 1) – holonomic robot can control all of its DOF  
*E.g., Multirotor aerial vehicle can control each DOF*
- **Nonholonomic** (CDOF<TDOF, the ratio < 1) – a nonholonomic robot has more DOF that it can control  
*E.g., a car*
- **Redundant** (CDOF>TDOF, the ratio > 1) – a redundant robot has more ways of control

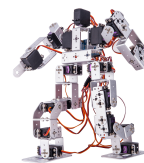

17 CDOF



6 DOF Hexapod



24 TDOF, 18 CDOF Hexapod

## Locomotion

- **Locomotion** refers how the robot body moves from one location to another location  
*From the Latin Locus (place) and motion*
- The most typical effectors and actuators for ground robots are **wheels** and **legs**
- Most of the robots need to be **stable** to work properly
  - **Static stability** – a robot can stand, it can be static and stable  
*Biped robots are not statically stable, more legs make it easier. Most of the wheeled robots are stable.*
  - **Statically stable walking** – the robot is stable all the times  
*E.g., hexapod with tripod gait*
  - **Dynamic stability** – the body must actively balance or move to remain stable, the robots are called dynamically stable  
*E.g., inverse pendulum*

## Locomotion – Legged Robots (Gaits)

- **Gait** is a way how a legged robot moves
- A gait defines the order how the individual legs lift and lower and also places of the foot tip on the ground
- Properties of gaits are: stability, speed, energy efficiency, robustness (how the gait can recover from some failures), simplicity (how complex is to generate the gait)
- A typical gait for hexapod walking robot is **tripod** which is stable as all the times at least three legs are on the ground

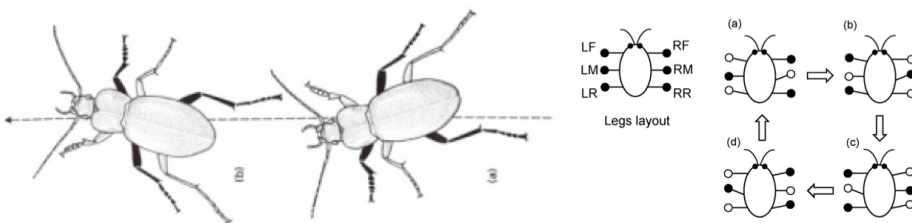

## Locomotion – Wheel Robots

- One of the most simple wheeled robots is **differential drive** robot
  - It has two driven wheels on a common axis
  - It uses castor wheels for stability
  - It is a nonholonomic robot  
*Omnidirectional robot is holonomic robot*

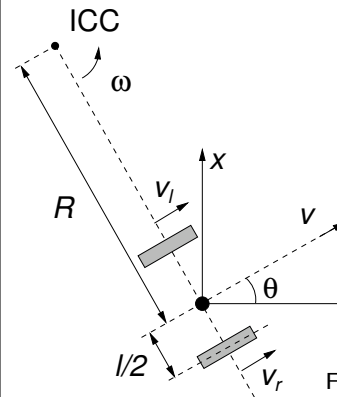

- $v_l$  and  $v_r$  are velocities along the ground of the left and right wheels, respectively
  - $\omega = \frac{v_r - v_l}{l}$ ,  $R = \frac{l}{2} \frac{v_l + v_r}{v_r - v_l}$
  - For  $v_l = v_r$ , the robot moves straight ahead  
*R is infinite*
  - For  $v_l = -v_r$ , the robot rotates in a place  
*R is zero*
  - Simple motion control can be realized in a turn-move like schema
- Further motion control using path following or trajectory following approaches with feedback controller based on the position of the robot to the path / trajectory

## Locomotion of Hexapod Walking Robot

- Let's have a hexapod robot with six identical legs, each with 3 DOF
- Each leg consists of three parts called **Coxa**, **Femur**, and **Tibia**



- The movement is a coordination of the **stance** and **swing** phases of the legs defined by the gait, e.g., tripod
- A **stride** is a combination of the leg movement with the foot tip on the ground (during the **stance phase**) and the leg movement in a particular direction (in the **swing phase**) within one **gait cycle**
- Various gaits can be created by different sequences of stance and swing phases
- $T_{Stance}$ ,  $T_{Swing}$ ,  $T_{Stride} = T_{Stance} + T_{Swing}$  defines the **duty factor**  
 $\beta = T_{Stance} / T_{Stride}$

Triod  $\beta = 0.5$

## Central Pattern Generator (CPG)

- **Central Pattern Generators (CPGs)** – are neural circuits to produce rhythmic patterns for various activities, i.e., locomotor rhythms to control a periodic movement of a particular body parts
- Salamander CPG with 20 amplitude-controlled phase oscillators

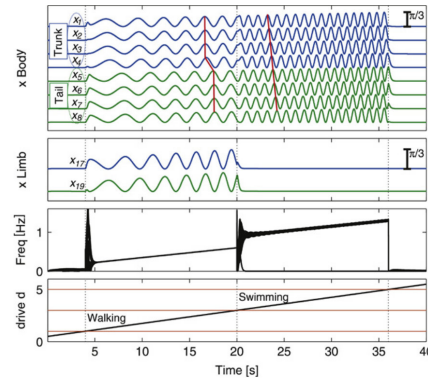
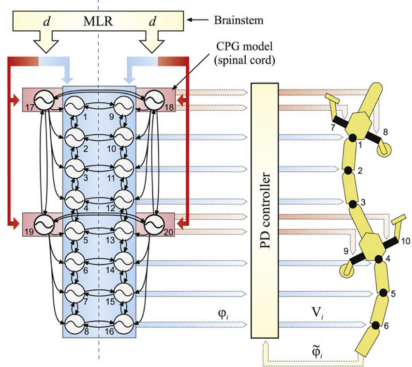

Auke Jan Ijspeert, Neural Networks, 2008

## Control Architectures

- A single control rule may provide simple robot behaviour
  - Notice, controller can be feed-forward (open-loop) or feedback controller as in the previous example with vision based sensing
- Robots should do more than just avoiding obstacles
- The question is “How to combine multiple controller together?”
- **Control architecture** is a set of guiding principles and constraints for organizing the robot control system
  - Guidelines to develop the robotic system to behave as desired
    - It is not necessary to know control architectures for simple robotic demos and tasks. But it is highly desirable to be aware of architectures for complex robots

## Example of Rhythmic Pattern Oscillator

- One of the widely used oscillators is the Matsuoka oscillator model
- It is based on biological concepts of the extensor and flexor muscles
- The rhythmic patterns defined the trajectory of the leg end point (foot tip)
- The coordinates of the foot tip can be utilized to compute the joint angles using the **Inverse Kinematics**

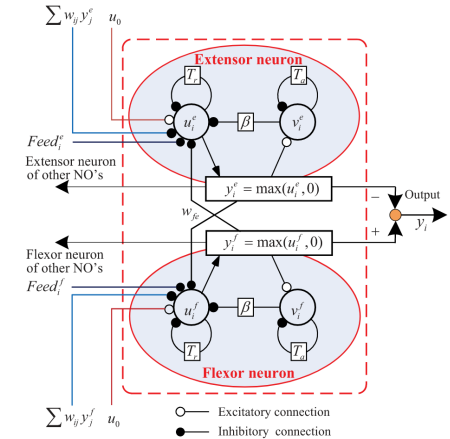

Matsuoka, K. (1985). Sustained oscillations generated by mutually inhibiting neurons with adaptation. *Biological Cybernetics* 52, 367–376

An example of simple CPG to control hexapod walking robot will be addressed during the labs

## Summary of the Lecture

## Topics Discussed

- Information about the Course
- Overview of robots, robotics, and challenges
  - Robot – Embodied software agent
  - Sensor, Controller, Actuators
  - Degrees of Freedom (DOF) and Controllable DOF
  - Mobile Robot Locomotion
  - Locomotion Gaits for Legged Robots
  - Central Pattern Generator
  
- Next: Robotic Paradigms and Control Architectures