

Colors in images

Color spaces, perception, mixing, printing, manipulating . . .

Tomáš Svoboda

Czech Technical University, Faculty of Electrical Engineering
Center for Machine Perception, Prague, Czech Republic

`svoboda@cmp.felk.cvut.cz`

`http://cmp.felk.cvut.cz/~svoboda`

Warning

- ◆ rather an overview lecture
- ◆ pictorial, math kept on minimum
- ◆ knowing keywords you may dig deeper

Thanks [Wikipedia](#) for many images.

Color Spectrum

Color is a human interpretation of a mixture of light with different wavelength λ (projected into a retina or camera photoreceptors).

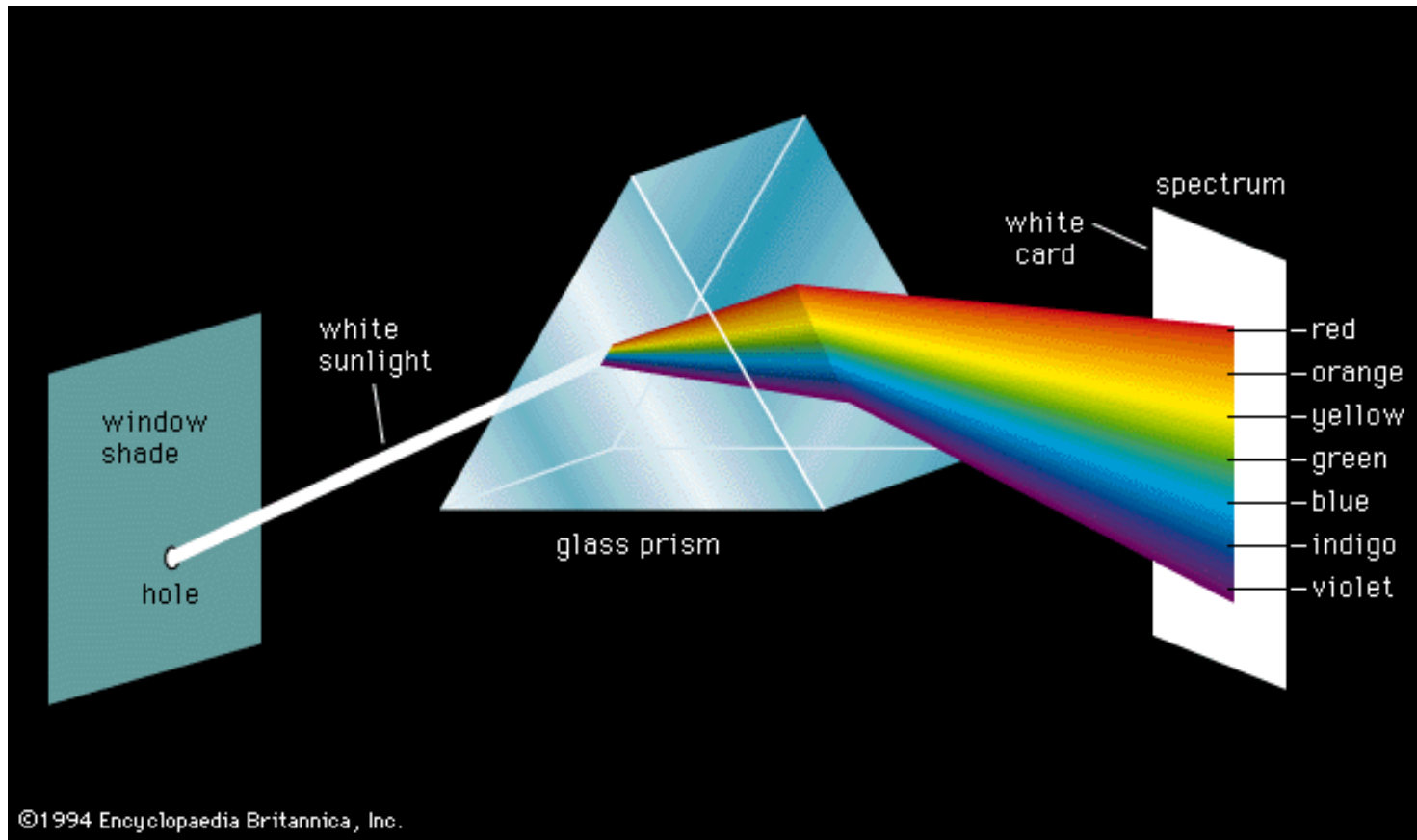

Isaac Newton's experiment (1666).

Perception of Light

- ◆ Human eye contains three types color receptor cells, or **cones**.
- ◆ Their sensitivity is a function of wavelength.
- ◆ Three peaks may be approximately identified in **BLUE**, **GREEN**, **RED**.
- ◆ Combination of the responses give us our color perception. **tristimulus model** of color vision.

Marking according to wavelengths

- ◆ **S** — short
- ◆ **M** — medium
- ◆ **L** — long

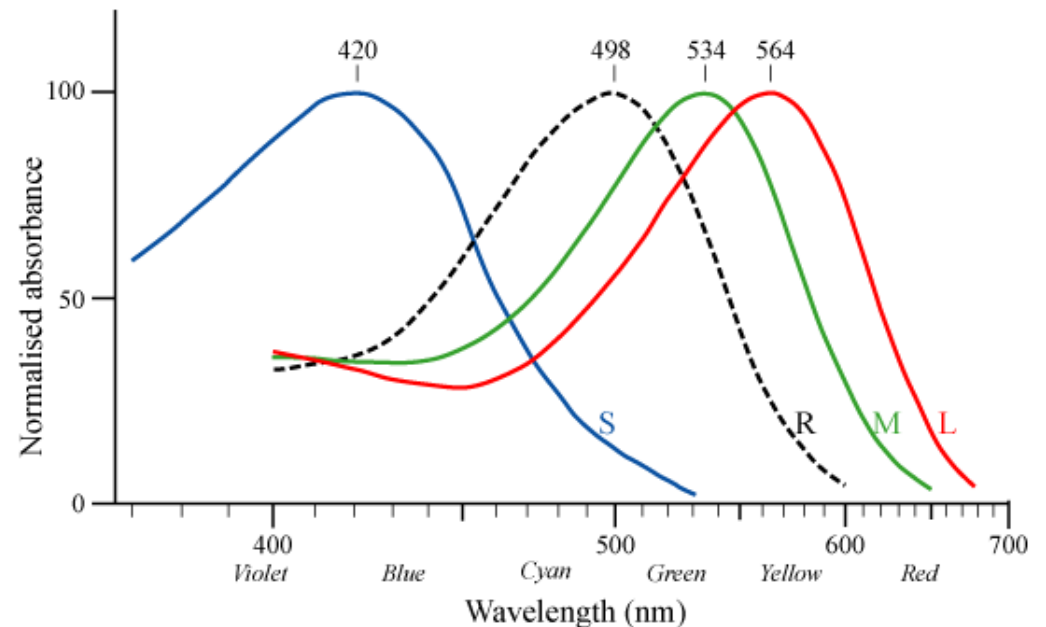

RGB color model

- ◆ A color point is represented by three numbers $[R, G, B]$
- ◆ $[R, G, B]$ have typically range 0 . . . 255 for most common 8-bit images

RGB color model

- ◆ A color point is represented by three numbers $[R, G, B]$
- ◆ $[R, G, B]$ have typically range 0. . . 255 for most common 8-bit images

red



RGB color model

- ◆ A color point is represented by three numbers $[R, G, B]$
- ◆ $[R, G, B]$ have typically range 0. . . 255 for most common 8-bit images

red



green



RGB color model

- ◆ A color point is represented by three numbers $[R, G, B]$
- ◆ $[R, G, B]$ have typically range 0. . . 255 for most common 8-bit images

red

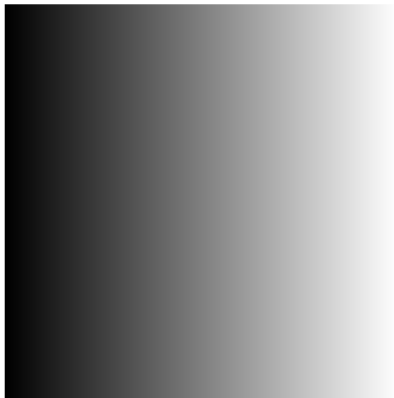

green



blue



RGB color model

- ◆ A color point is represented by three numbers $[R, G, B]$
- ◆ $[R, G, B]$ have typically range 0. . . 255 for most common 8-bit images



RG only, B zero

red



green



rg

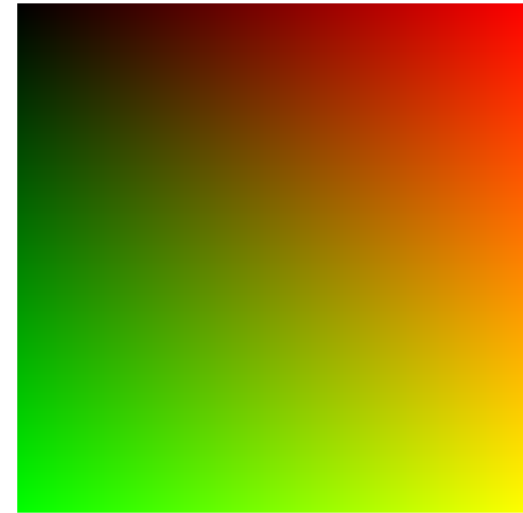

RB only, G zero

red



blue

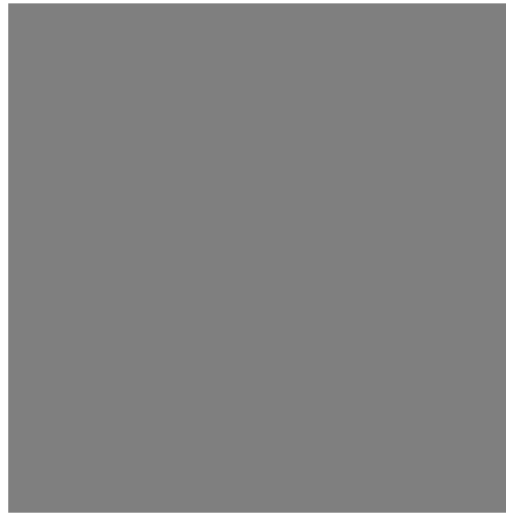

rb



GB only, R zero

green



blue



gb



Additive mixing

- ◆ computer screens, TV, projectors
- ◆ **Primary** colors: ones used to define other colors, [R,G,B]
- ◆ **Secondary** colors: pairwise combination of primaries, [C,M,Y] (Cyan, Magenta, Yellow)

Additive mixing

- ◆ computer screens, TV, projectors
- ◆ **Primary** colors: ones used to define other colors, [R,G,B]
- ◆ **Secondary** colors: pairwise combination of primaries, [C,M,Y] (Cyan, Magenta, Yellow)

red

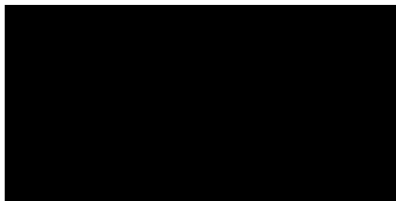

Additive mixing

- ◆ computer screens, TV, projectors
- ◆ **Primary** colors: ones used to define other colors, [R,G,B]
- ◆ **Secondary** colors: pairwise combination of primaries, [C,M,Y] (Cyan, Magenta, Yellow)

red

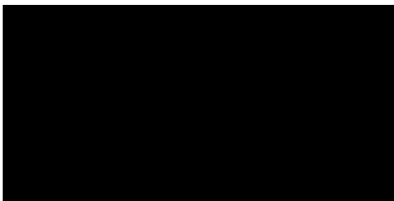

green

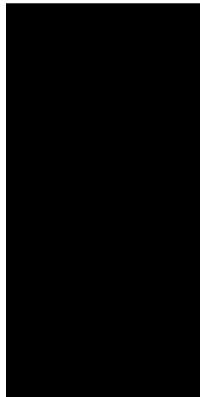

Additive mixing

- ◆ computer screens, TV, projectors
- ◆ **Primary** colors: ones used to define other colors, [R,G,B]
- ◆ **Secondary** colors: pairwise combination of primaries, [C,M,Y] (Cyan, Magenta, Yellow)

red

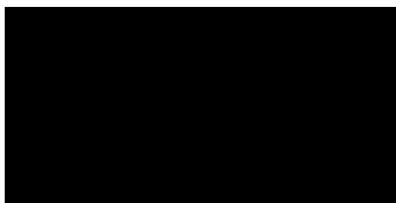

green

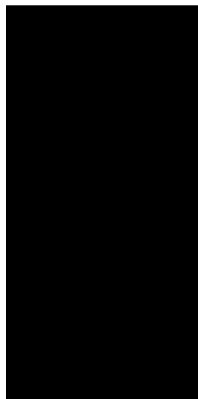

blue

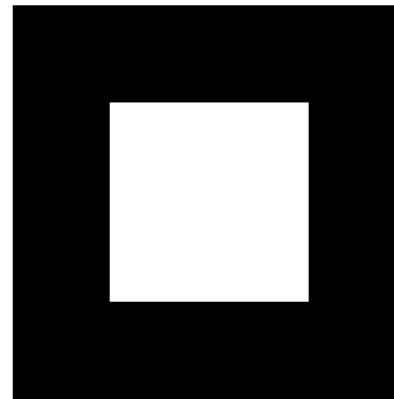

Additive mixing

- ◆ computer screens, TV, projectors
- ◆ **Primary** colors: ones used to define other colors, [R,G,B]
- ◆ **Secondary** colors: pairwise combination of primaries, [C,M,Y] (Cyan, Magenta, Yellow)

red

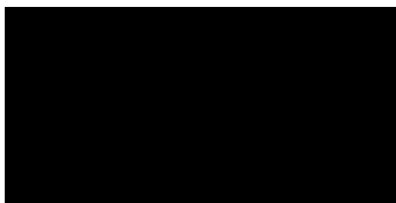

green

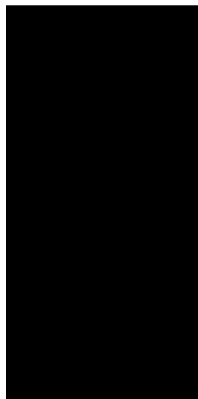

blue

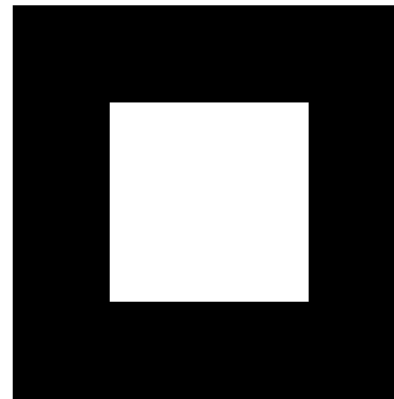

rgb

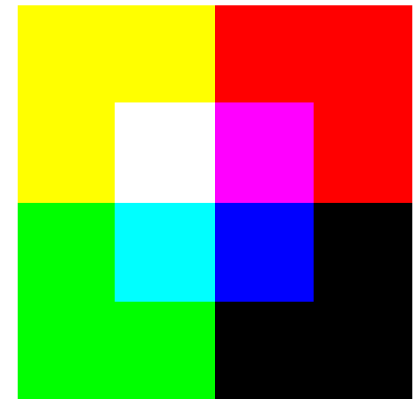

RG only, B zero

red

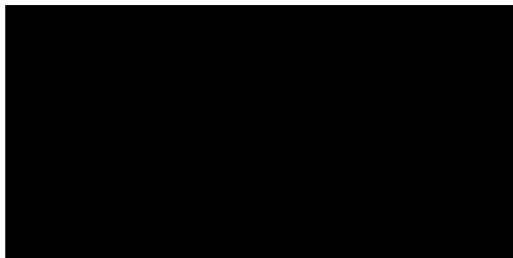

green

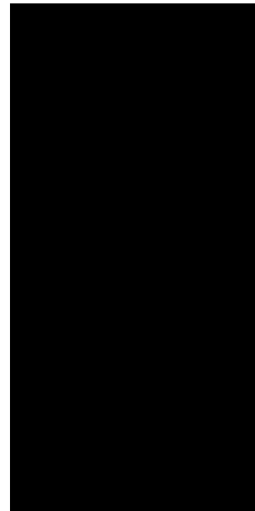

rg

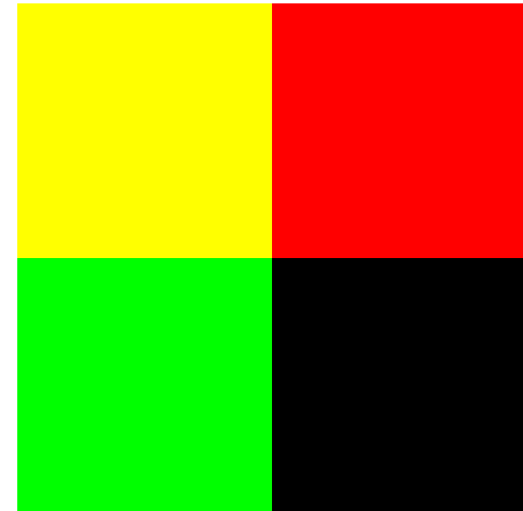

RB only, G zero

red

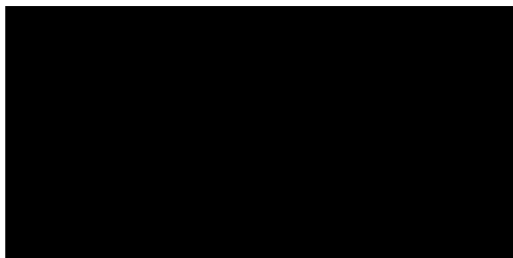

blue

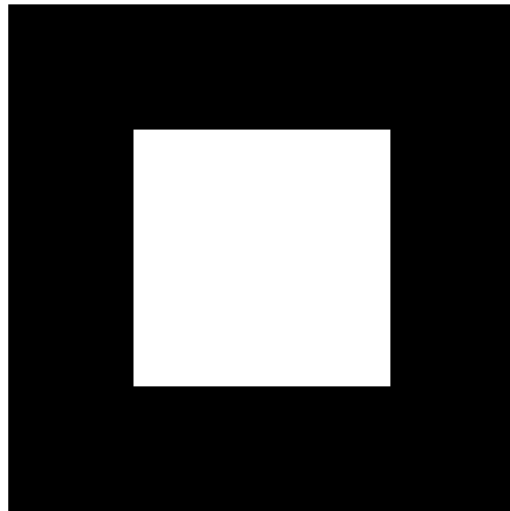

rb

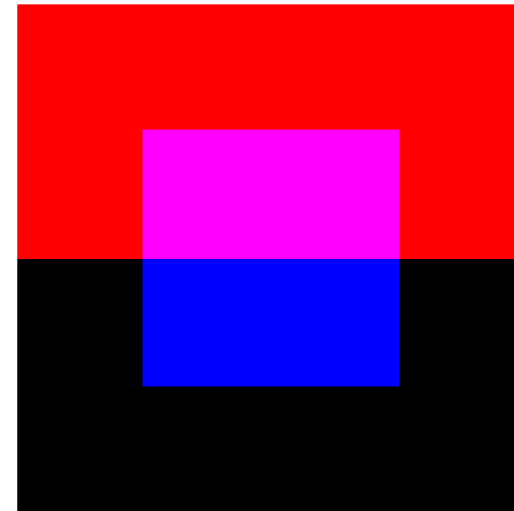

GB only, R zero

green



blue

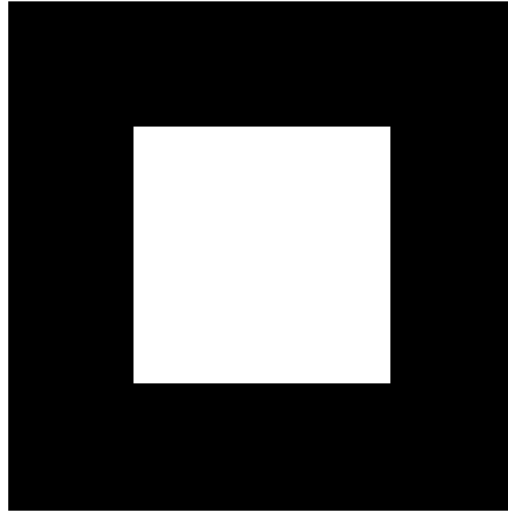

gb

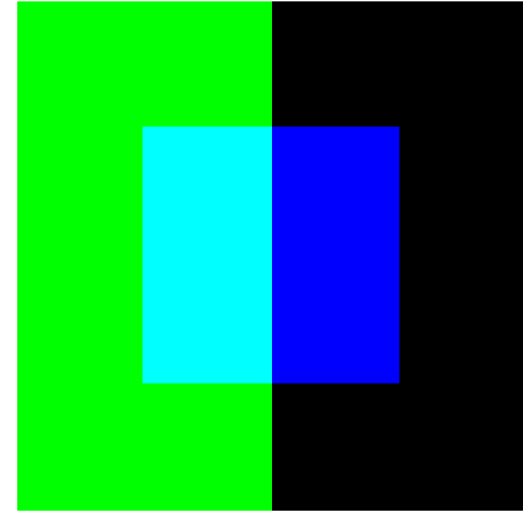

Subtractive mixing

- ◆ it works through **light absorption**
- ◆ the colors that are seen are from the part of light that is not absorbed
- ◆ paintings, printing, . . .
- ◆ **Primary** colors: ones used to define other colors [C,M,Y]
- ◆ **Secondary** colors: pairwise combination of primaries [R,G,B]

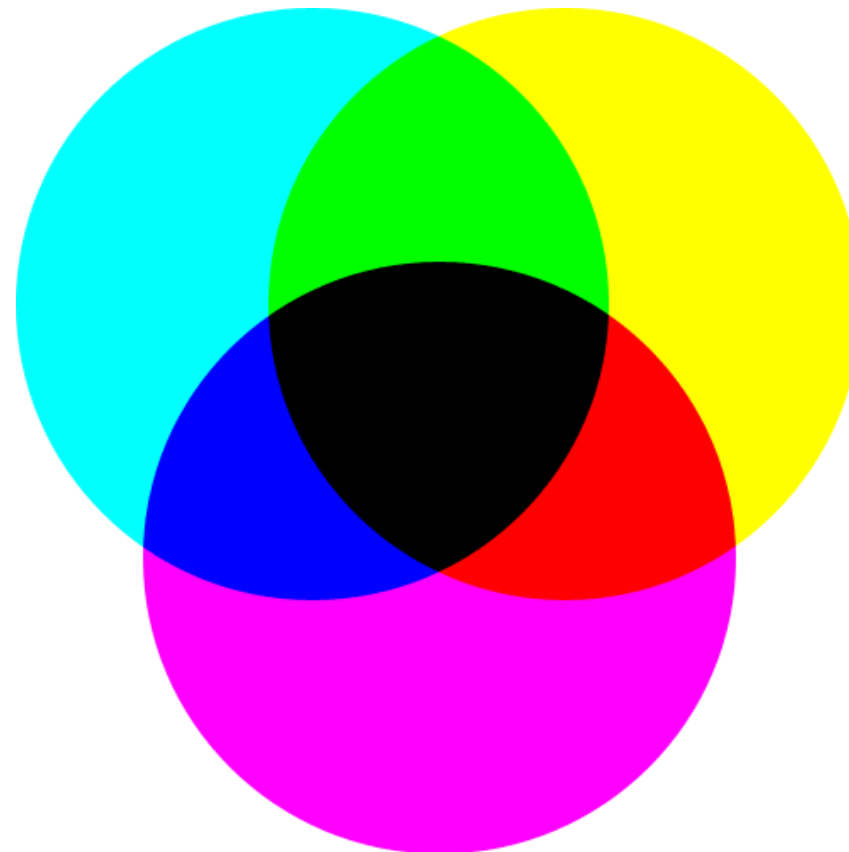
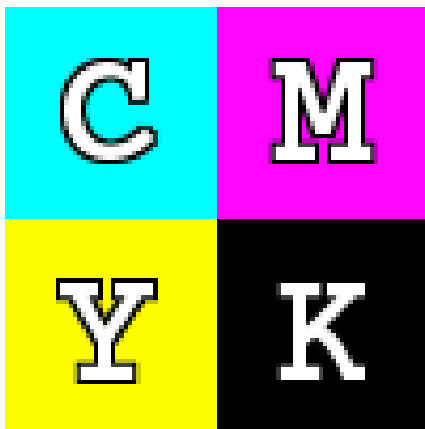

CMYK model

- ◆ color primaries [C,M,Y] should result black when all mixed together
- ◆ in practice, such black is not dense enough
- ◆ K = key (black) is added to the model

CMYK model

- ◆ color primaries [C,M,Y] should result black when all mixed together
- ◆ in practice, such black is not dense enough
- ◆ K = key (black) is added to the model

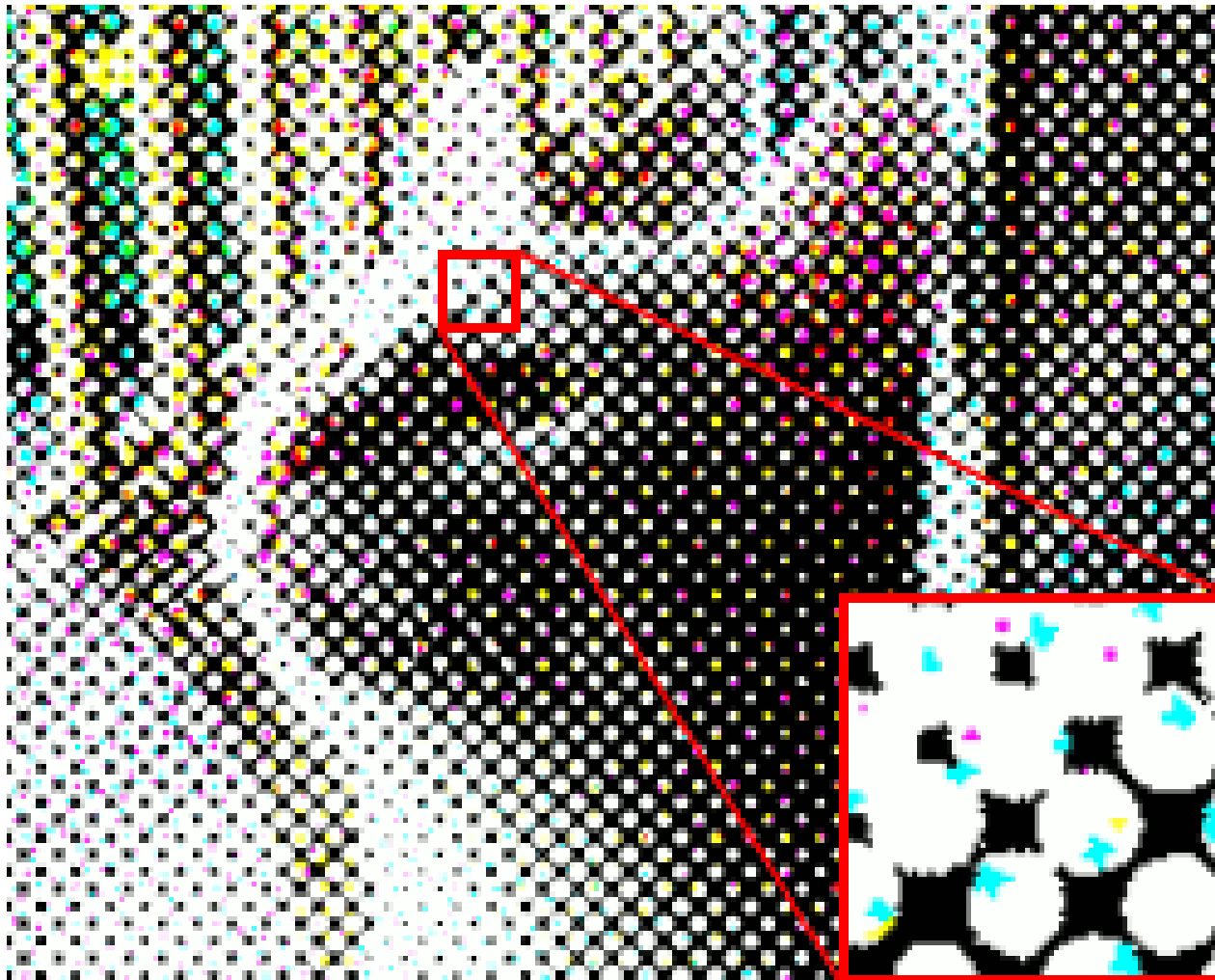

Capturing RGB values

- ◆ We know how to display, print color
- ◆ How to capture?
- ◆ CCD generates output proportionally to amount of energy

Capturing RGB values

- ◆ We know how to display, print color . . .
- ◆ How to capture?
- ◆ CCD generates output proportionally to amount of energy

3CCD camera with separating dichroic beam splitter

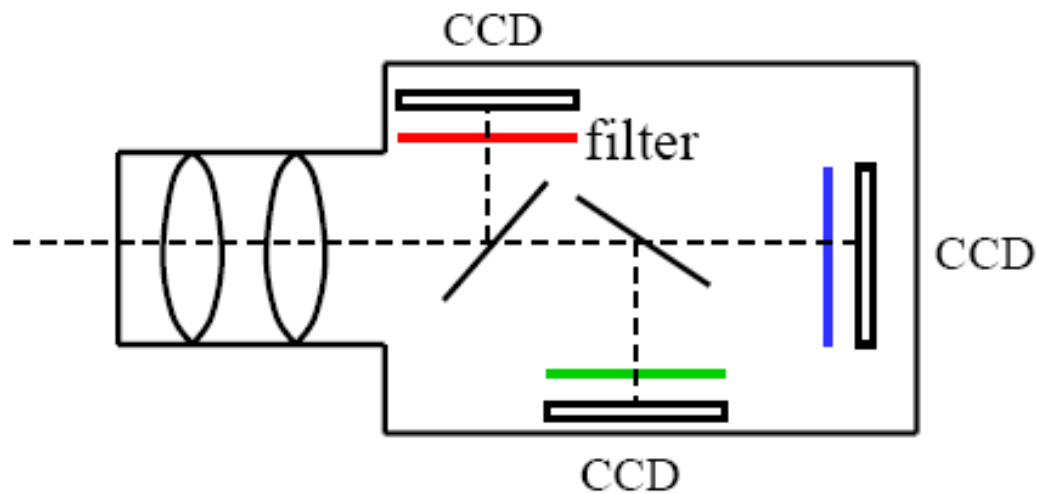

3CCD chip camera

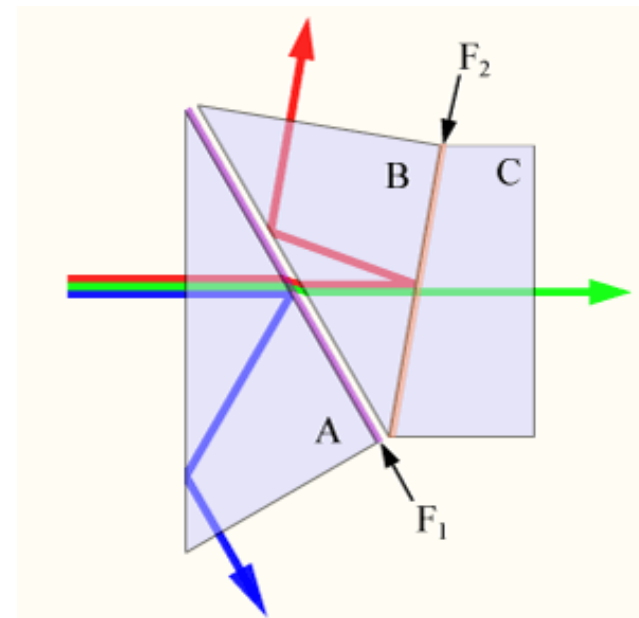

dichroic prism

Capturing RGB values

- ◆ We know how to display, print color . . .
- ◆ How to capture?
- ◆ CCD generates output proportionally to amount of energy

3CCD camera with separating dichroic beam splitter

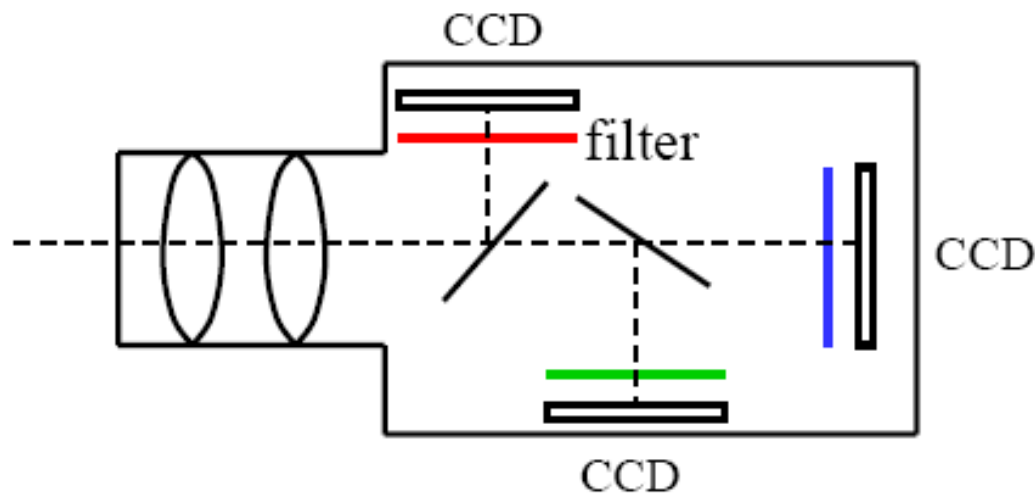

3CCD chip camera

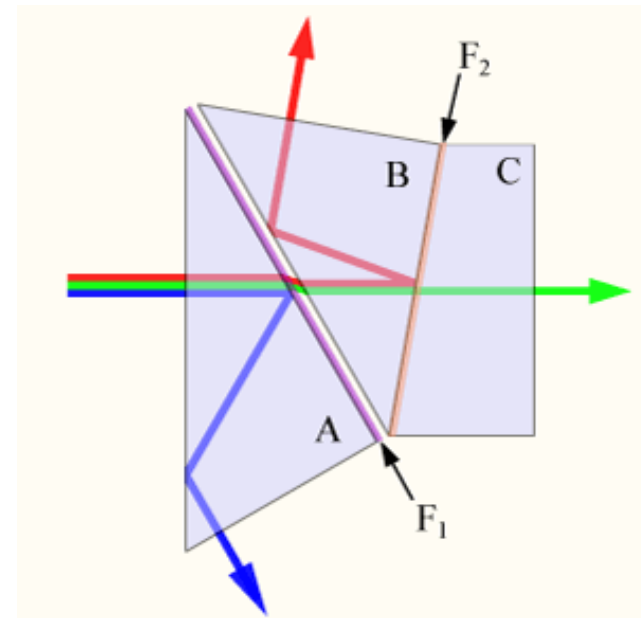

dichroic prism

Good: Color quality, Problem: price . . .

1CCD camera with Bayer filter

- ◆ use one chip
- ◆ place a selective filter in front of it
- ◆ 2:1:1, 2 to green, human eye is most sensitive to it
- ◆ combine values to make RGB image
Demosaicking
- ◆ cheap but the image quality suffers
- ◆ this is, among other things, what makes difference between digital photo cameras

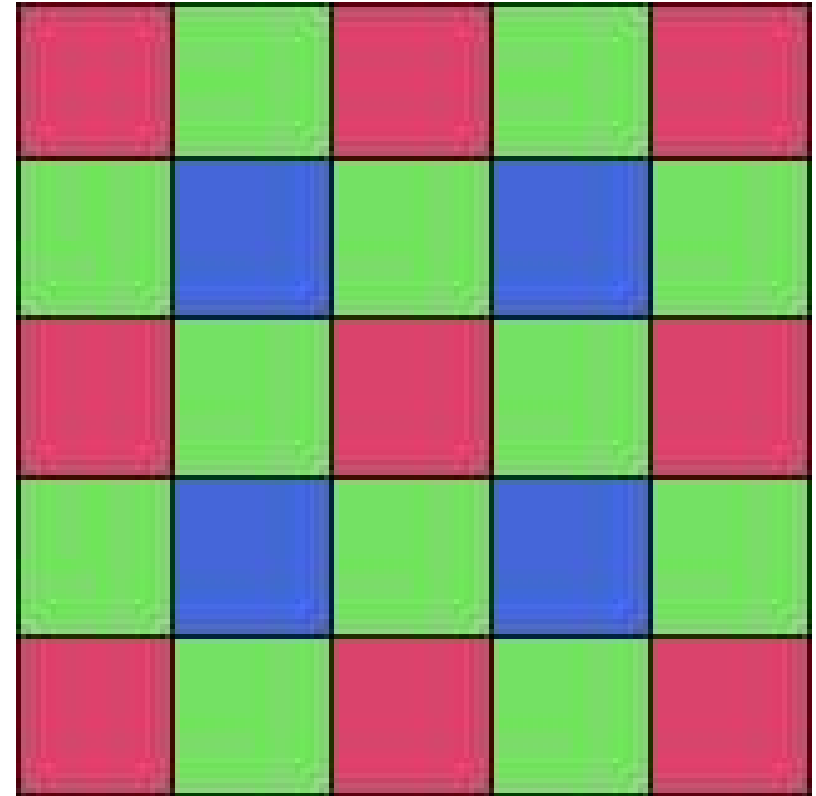

Demosaicking in images



Demosaicking in images

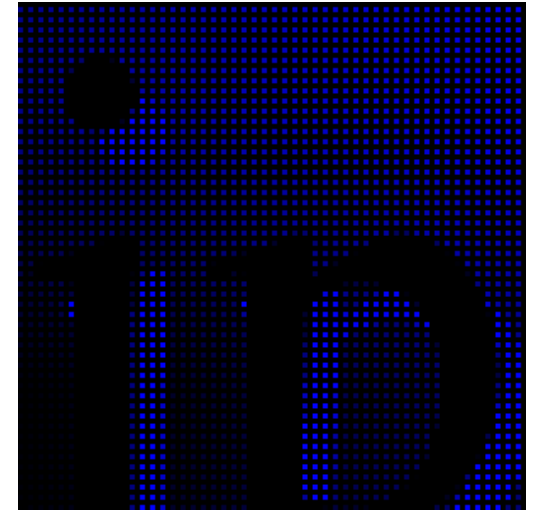
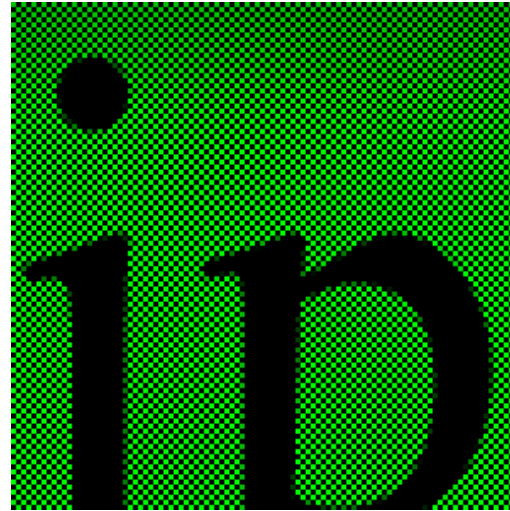
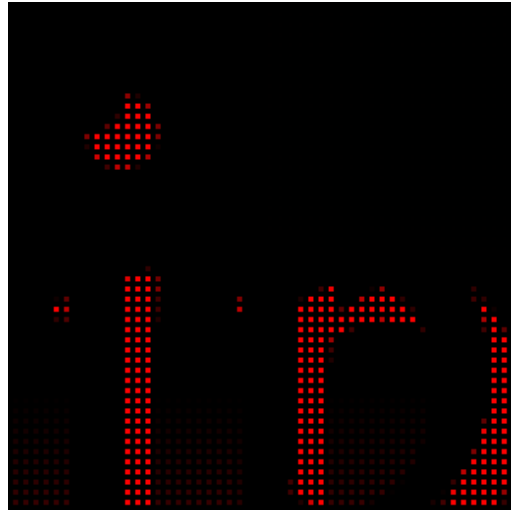

Demosaicking result



Many demosaicking method exist. 1CCD with a filter is still prevailing solution. Few expensive DV cameras in consumer level. A company Foveon found yet another way . . .

Color from “depths”

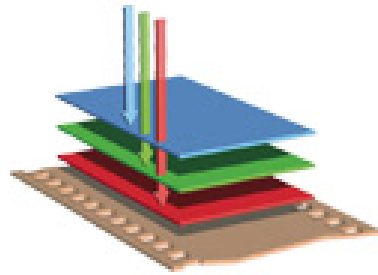

First came film.

COLOR FILM contains three layers of emulsion which directly record red, green, and blue light.

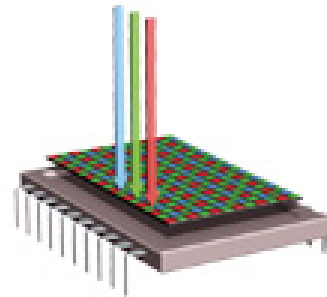

Then came digital.

TYPICAL DIGITAL SENSORS have just one layer of pixels and capture only part of the color.

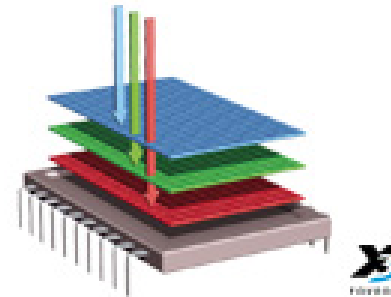

Now there's Foveon X3.

FOVEON X3 direct image sensors have three layers of pixels which directly capture all of the color.

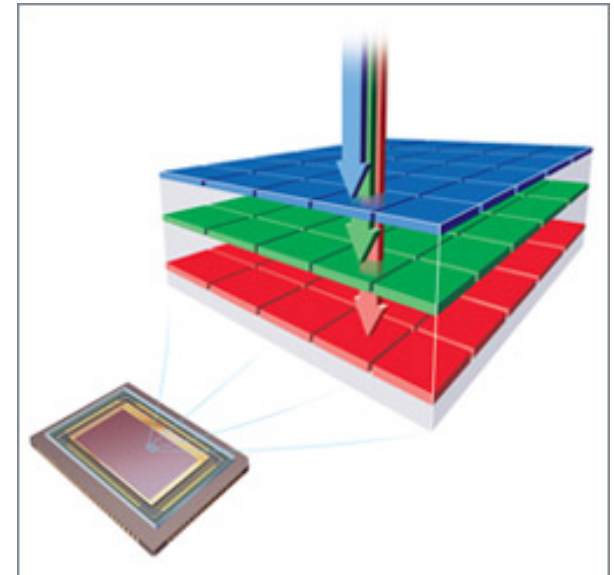

Capturing color — revisited

- ◆ Many demosaicking methods exist.
- ◆ 1CCD with a filter is still the prevailing solution.
- ◆ Few expensive DV cameras are at the consumer level.
- ◆ A company called Foveon found yet another way . . .

HSV color space

- ◆ Problem in RGB space: How would you create a color according to your design?
- ◆ RGB values do not correspond to human thinking about colors
- ◆ We are saying: pure red, deep purple, sky blue . . .

HSV color space

- ◆ Problem in RGB space: How would you create a color according to your design?
- ◆ RGB values do not correspond to human thinking about colors
- ◆ We are saying: pure red, deep purple, sky blue . . .

HSV Hue, Saturation, Value color space

- ◆ **Hue** is the color type (red, yellow, . . .)
- ◆ **Saturation** refers to color purity or vibrancy
- ◆ **Value** is the brightness of the color

HSV cone

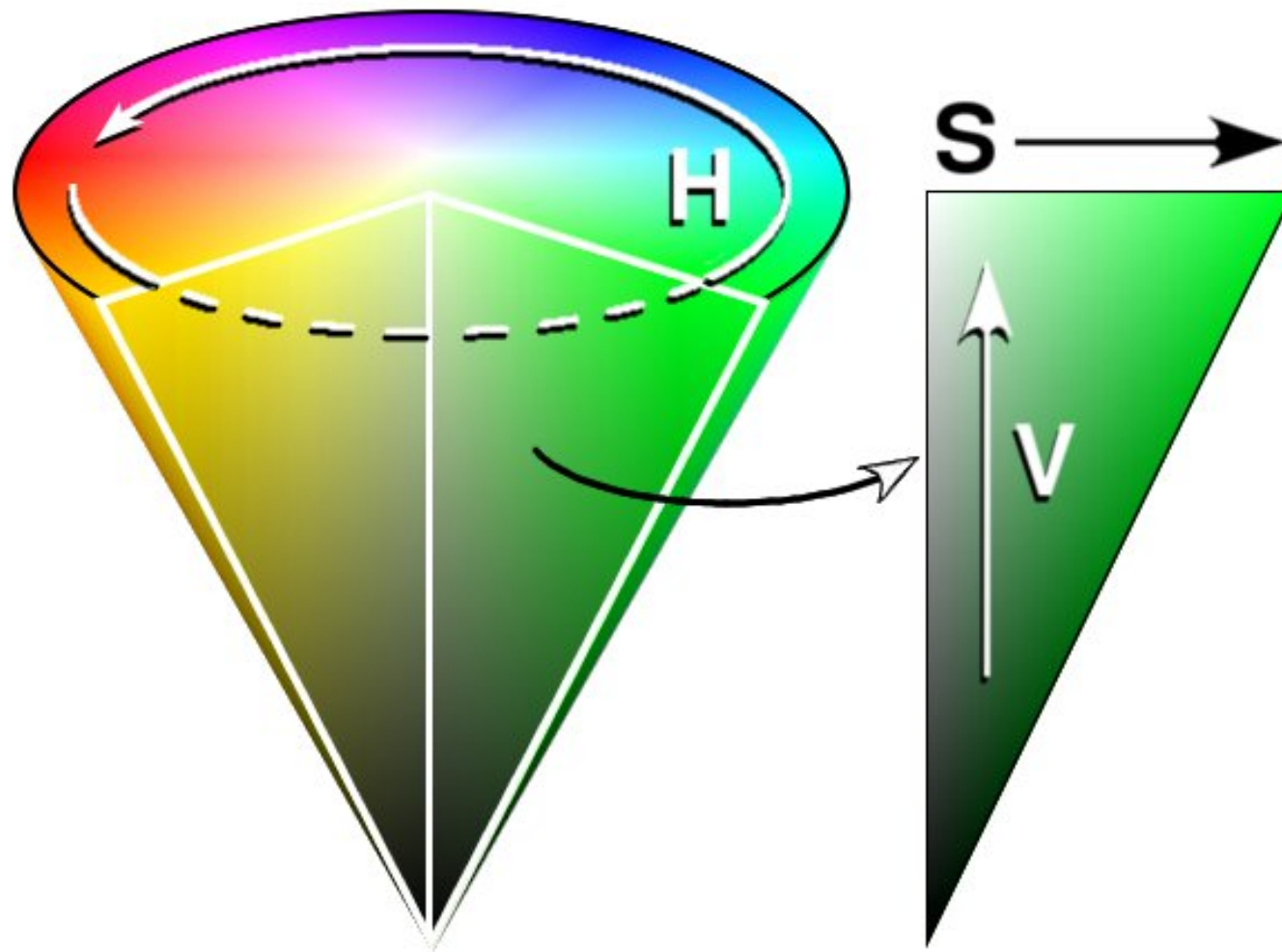

Playing with saturation



original image



what a nice autumn!

Playing with saturation



original image



what a sad gray autumn!

Additive mixing — revisited

- ◆ Can we, assuming properly chosen $[R,G,B]$, mix any color?

Additive mixing — revisited

- ◆ Can we, assuming properly chosen $[R,G,B]$, mix any color?
- ◆ Well, almost any.

What is wrong?

Additive mixing — revisited

- ◆ Can we, assuming properly chosen $[R,G,B]$, mix any color?
- ◆ Well, almost any.

What is wrong?

- ◆ Blue and Green makes Cyan.
- ◆ But how to make monochromatic Cyan?
- ◆ $\text{blue} + \text{green} - (\text{little red}) = \text{monochromatic cyan}$
- ◆ but how to make negative values on screens?

What do you need to match any color?

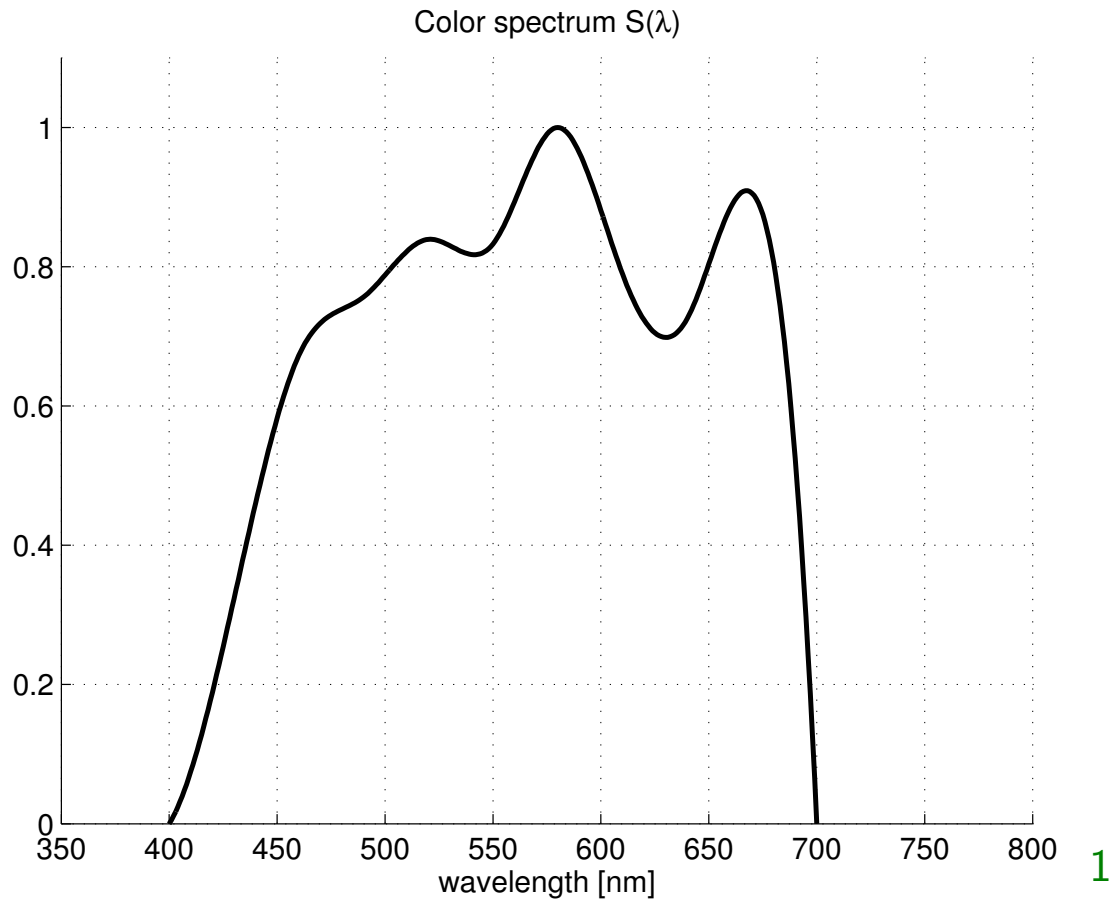

- ◆ Table of $S(\lambda)$ in predefined λ
- ◆ $S(\lambda) = P_1 \int f_1(\lambda)S(\lambda)d\lambda + P_2 \int f_2(\lambda)S(\lambda)d\lambda + P_3 \int f_3(\lambda)S(\lambda)d\lambda$
which gives us $[P_1, P_2, P_3]$ representation.

¹Data tables can be downloaded from <http://www.cvrl.org>

What *RGB* do you need to match any color?

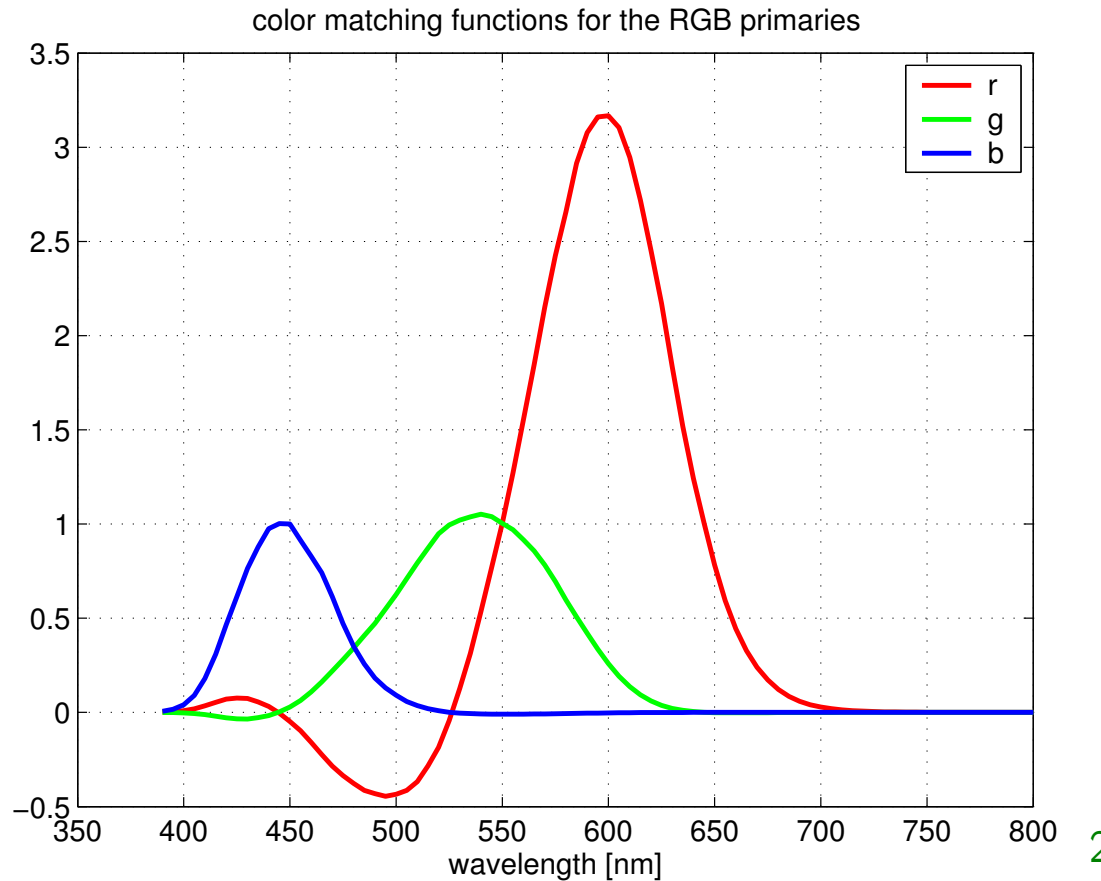

$$S(\lambda) = R \int r(\lambda) S(\lambda) d\lambda + G \int g(\lambda) S(\lambda) d\lambda + B \int b(\lambda) S(\lambda) d\lambda$$

Problem: How to realize devices with negative matching functions?

²Data tables can be downloaded from <http://www.cvrl.org>

A way out — new primary “colors” CIE XYZ

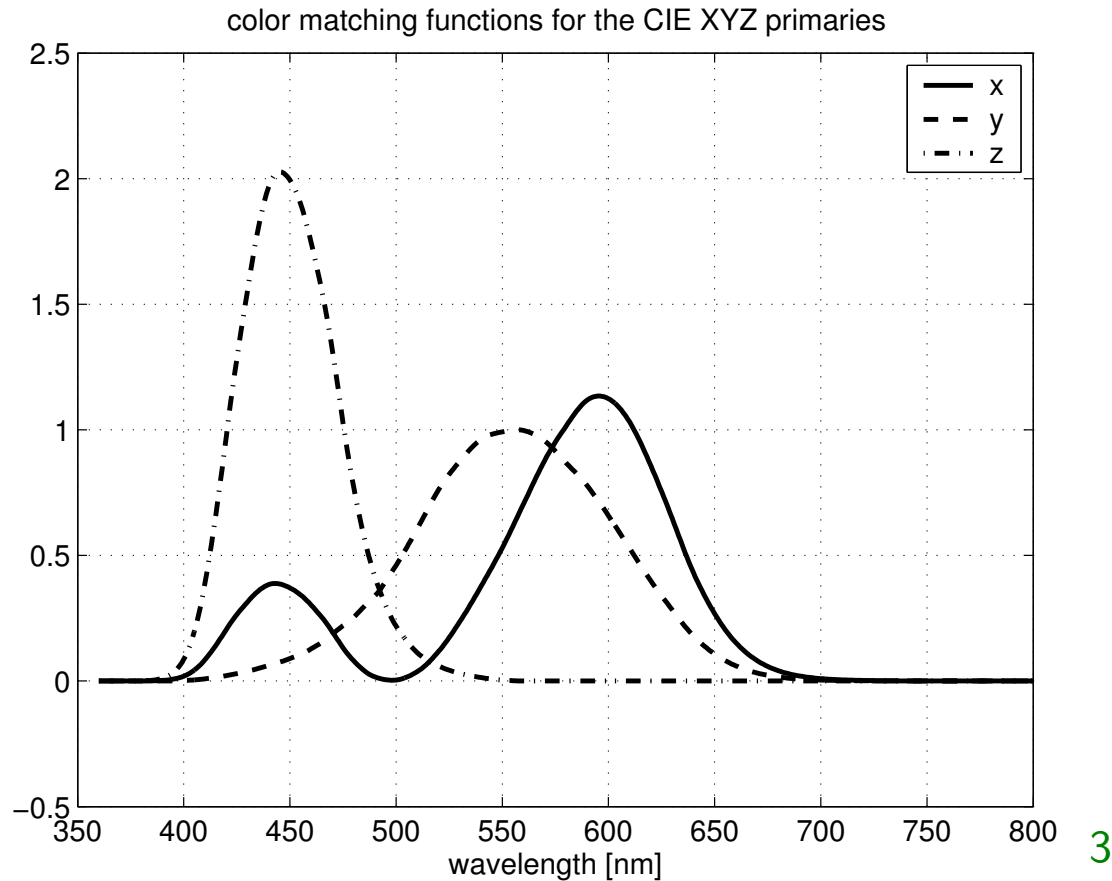

$$S(\lambda) = X \int x(\lambda) S(\lambda) d\lambda + Y \int y(\lambda) S(\lambda) d\lambda + Z \int z(\lambda) S(\lambda) d\lambda$$

³Data tables can be downloaded from <http://www.cvrl.org>

CIE chromaticity diagram

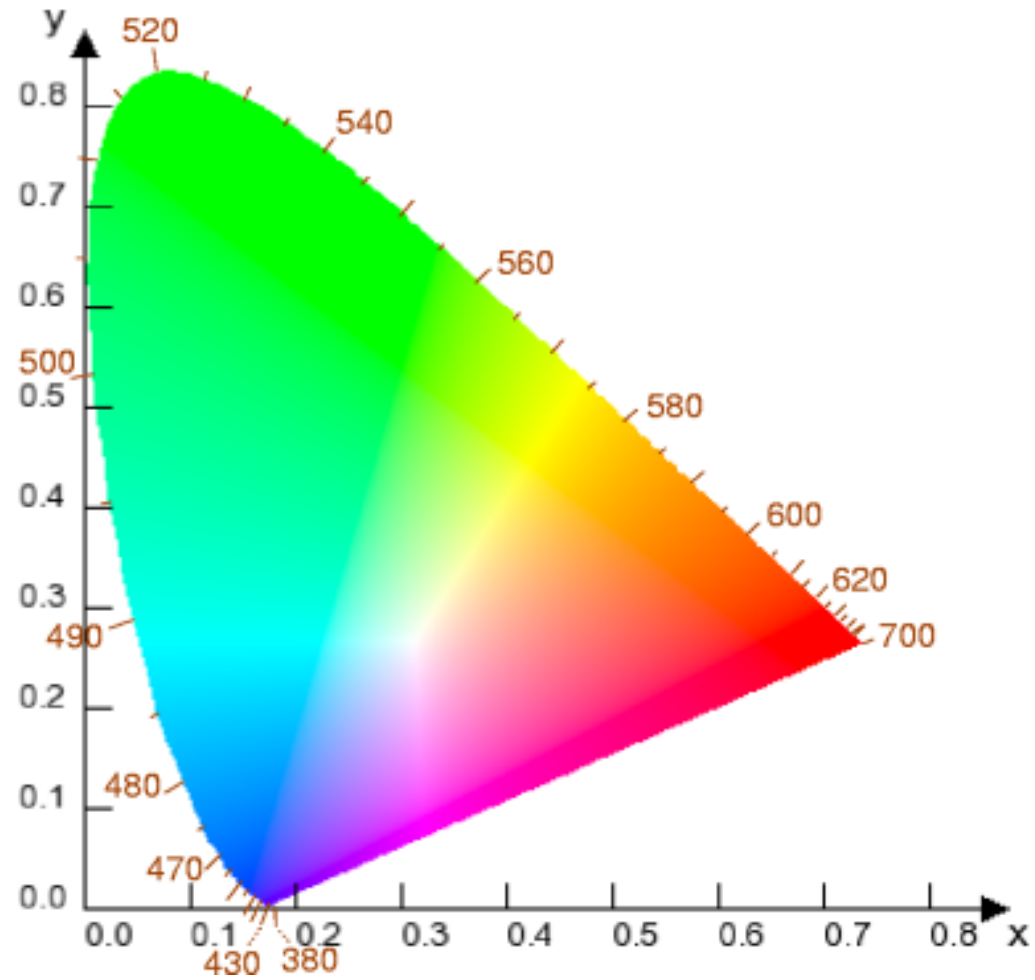

$$[x, y] = \left[\frac{X}{X + Y + Z}, \frac{Y}{X + Y + Z} \right]$$

Do we see all colors on the screen?

Do we see all colors on the screen?

No!

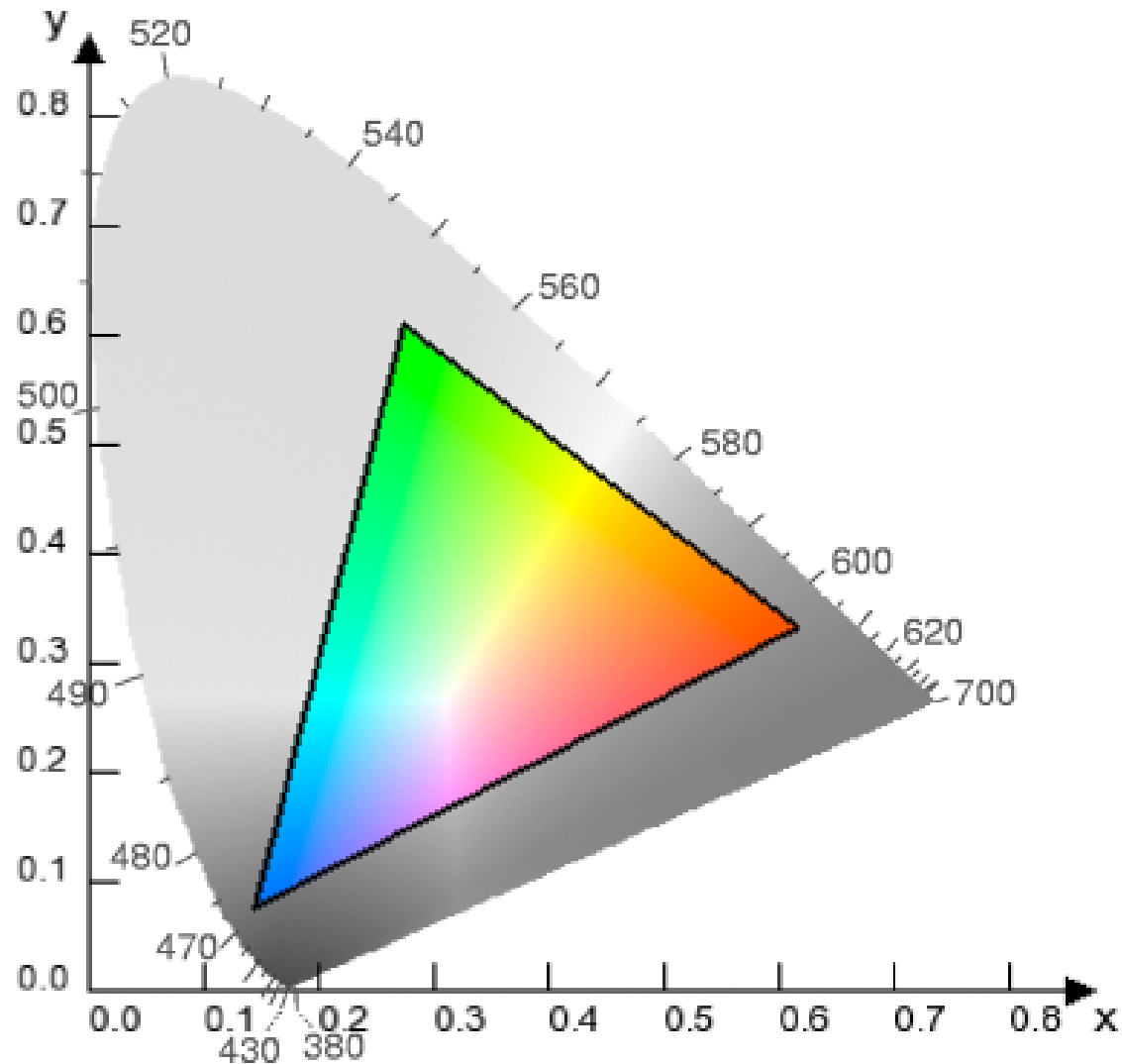

Typical **gamut** of a CRT monitor

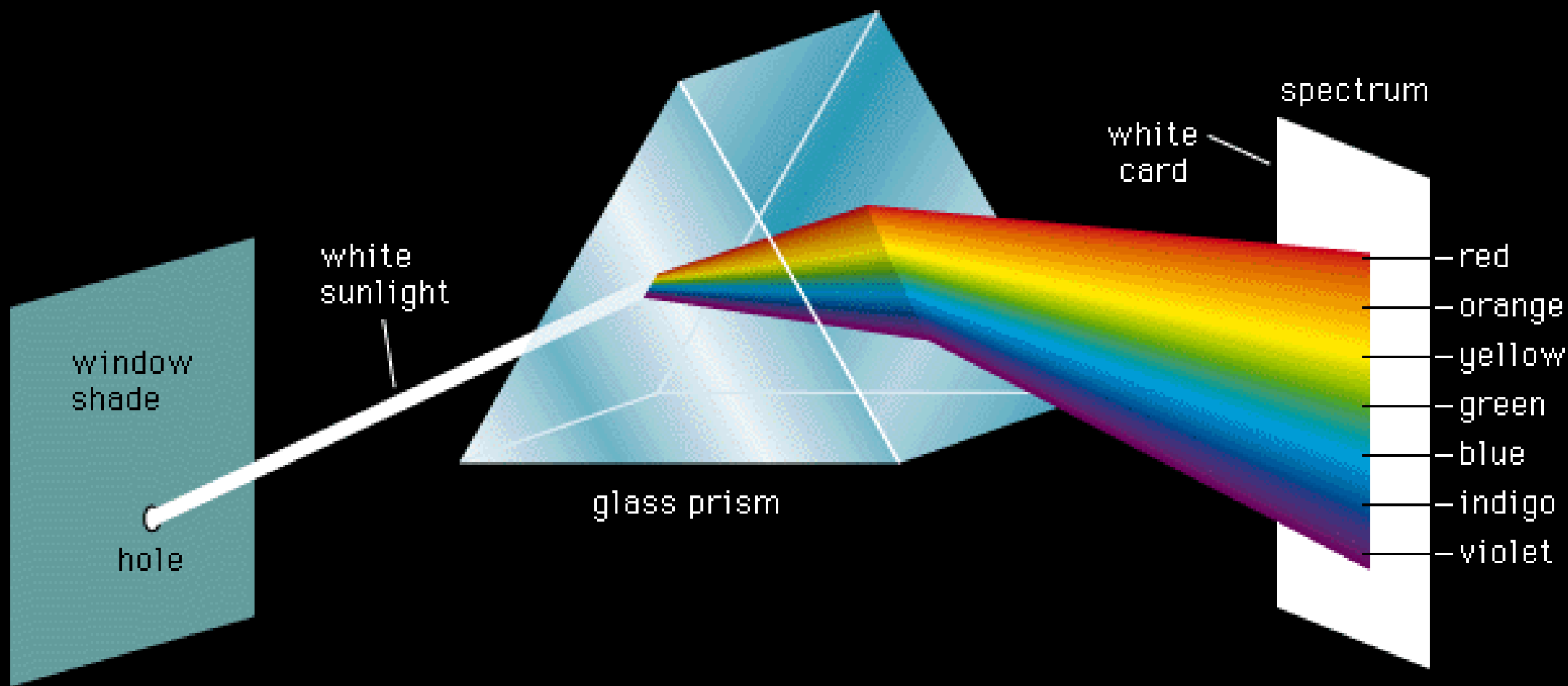

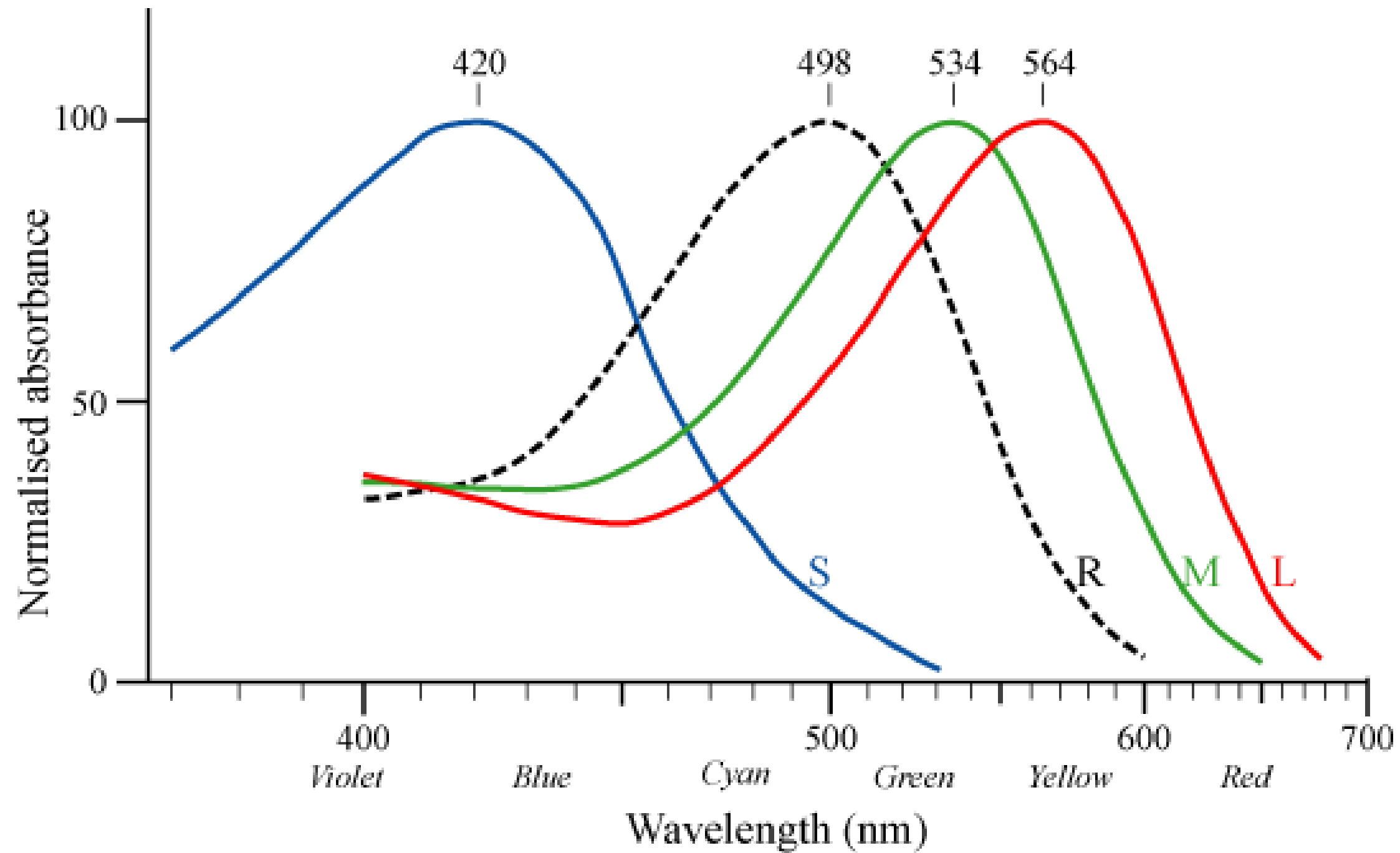

red



green



blue

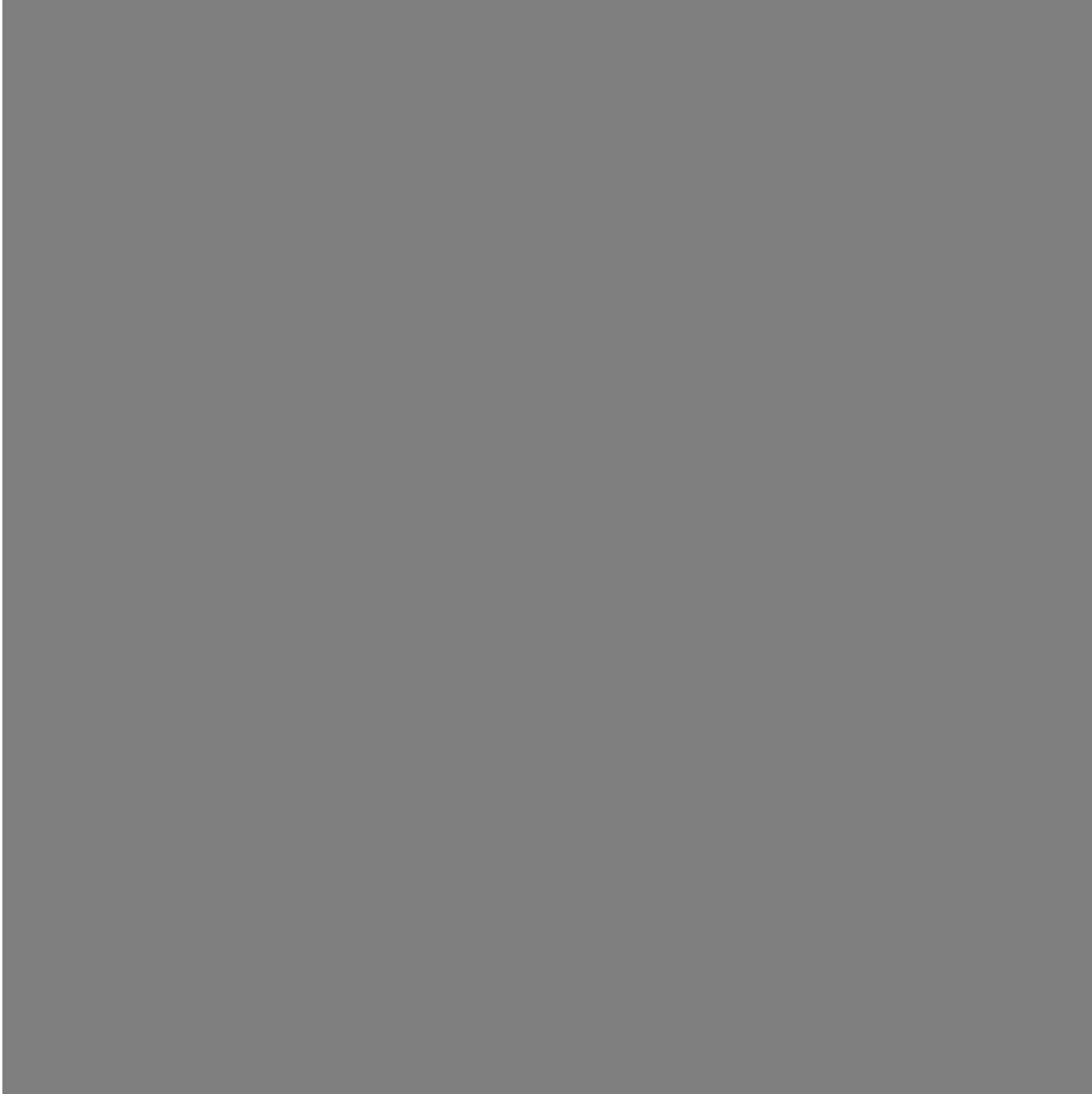

rgb



red



green



blue



rgb



red



green



blue

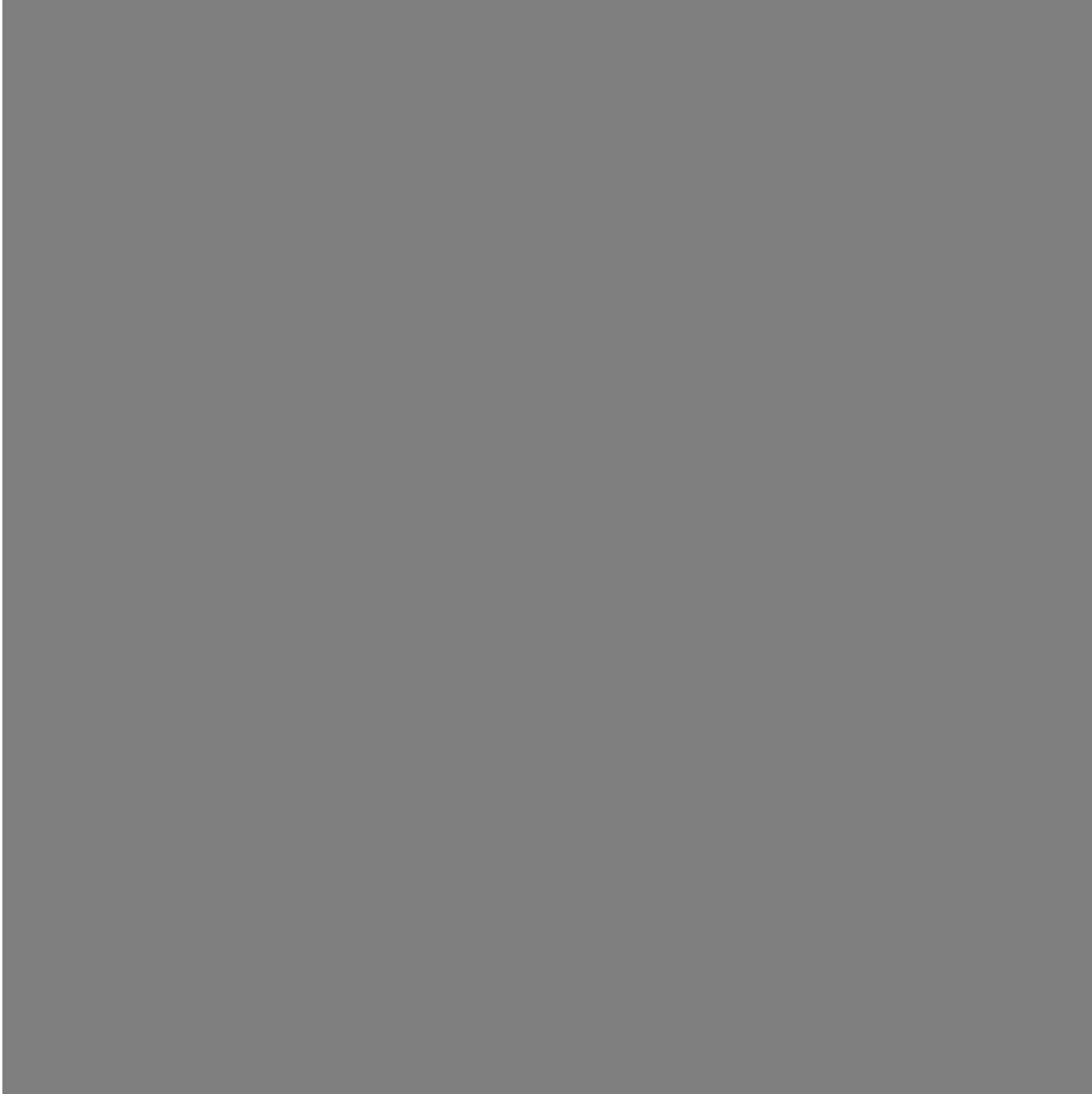

rgb



red



green



blue



rgb



red



green



blue

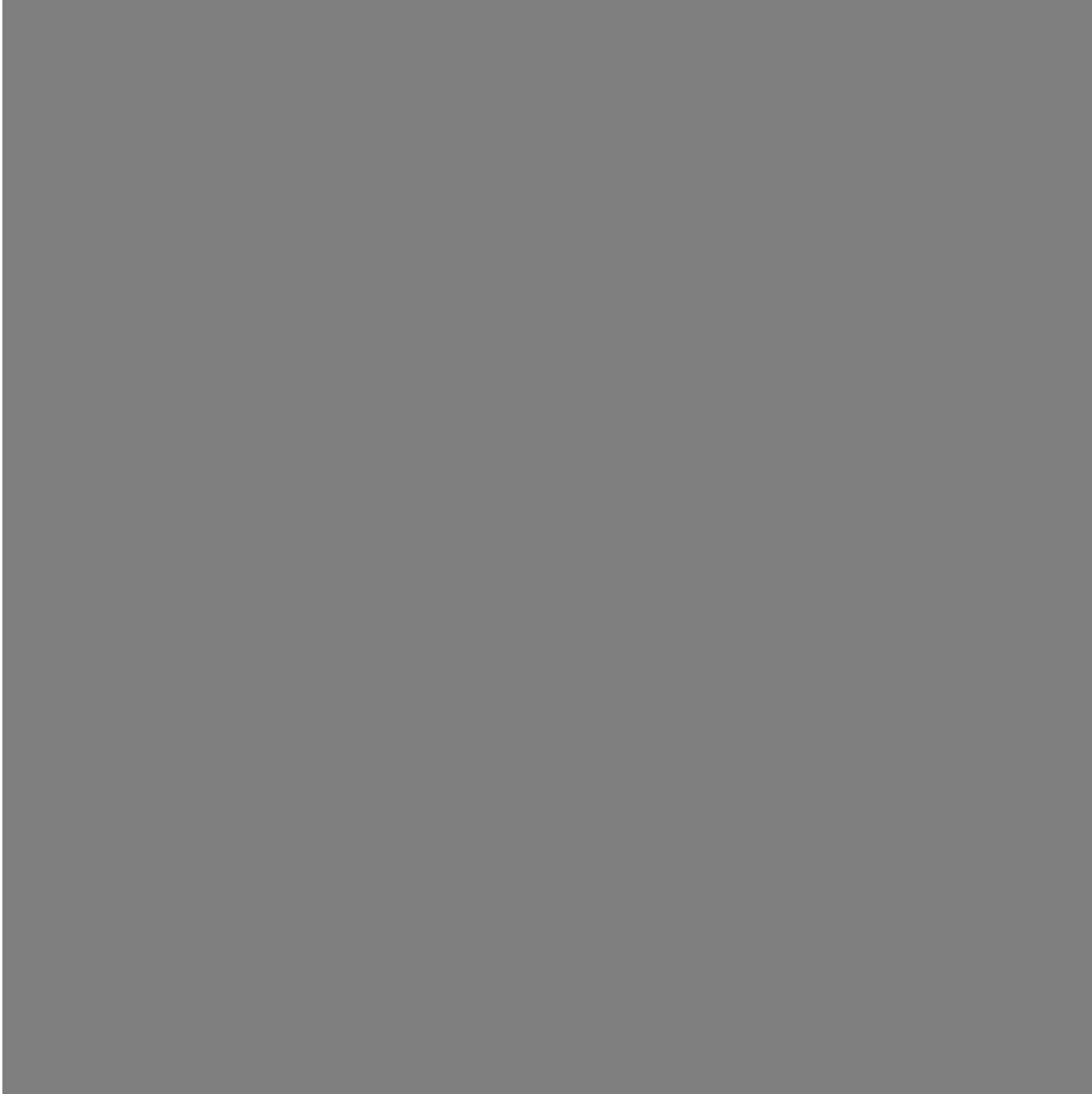

rgb



red

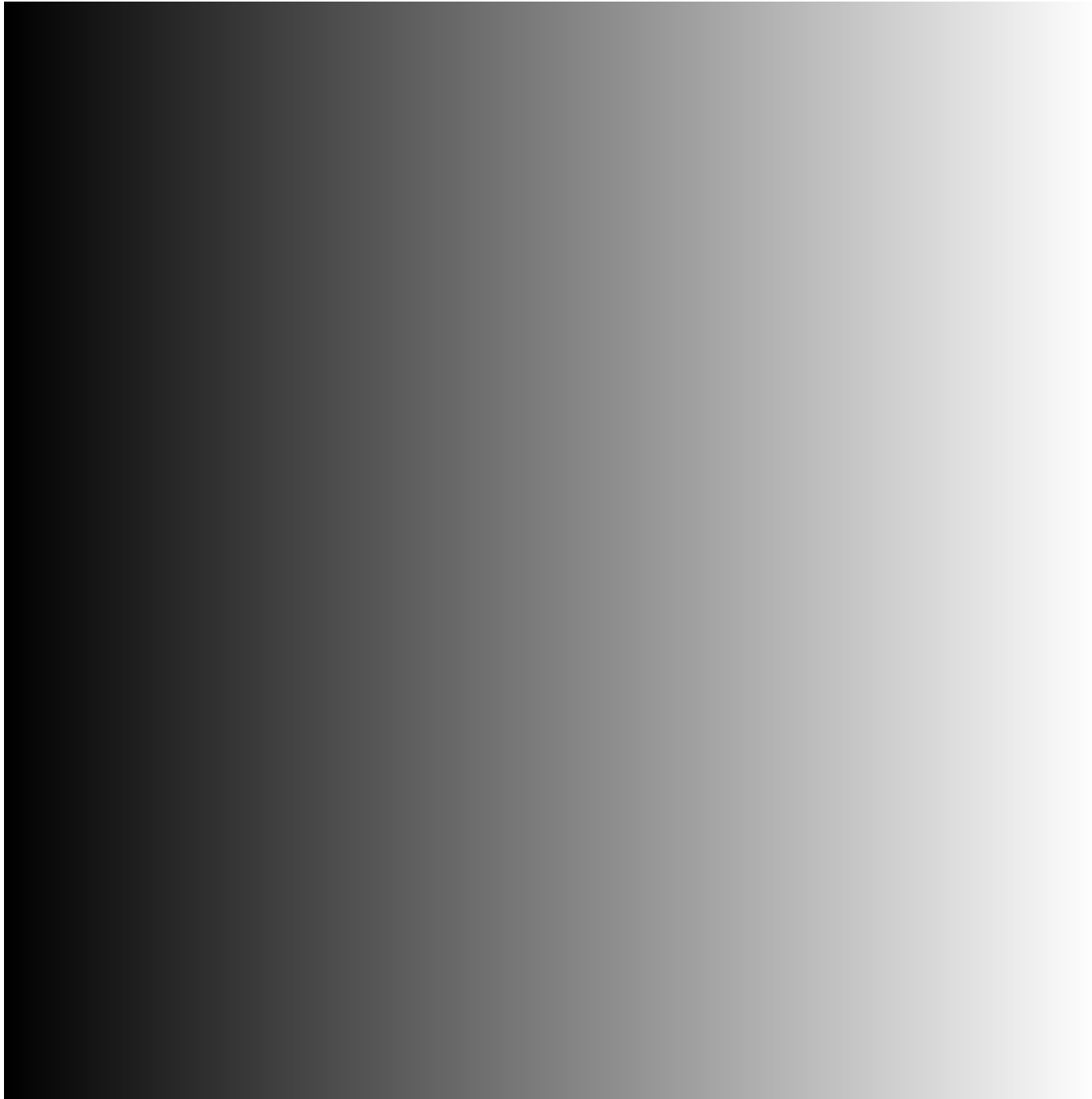

green



blue



rgb



red



green



rg

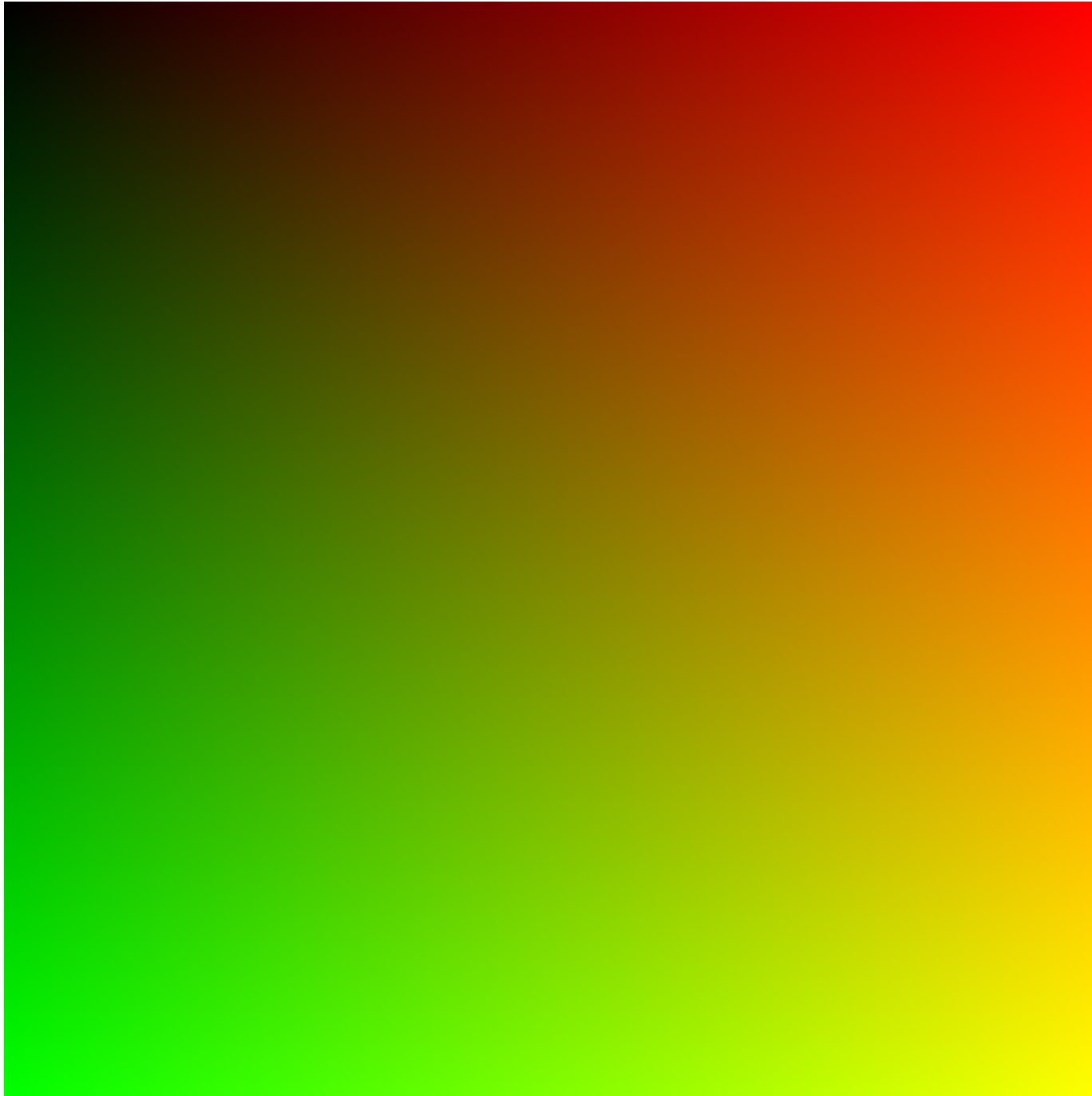

red



blue



rb



green



blue



gb



red

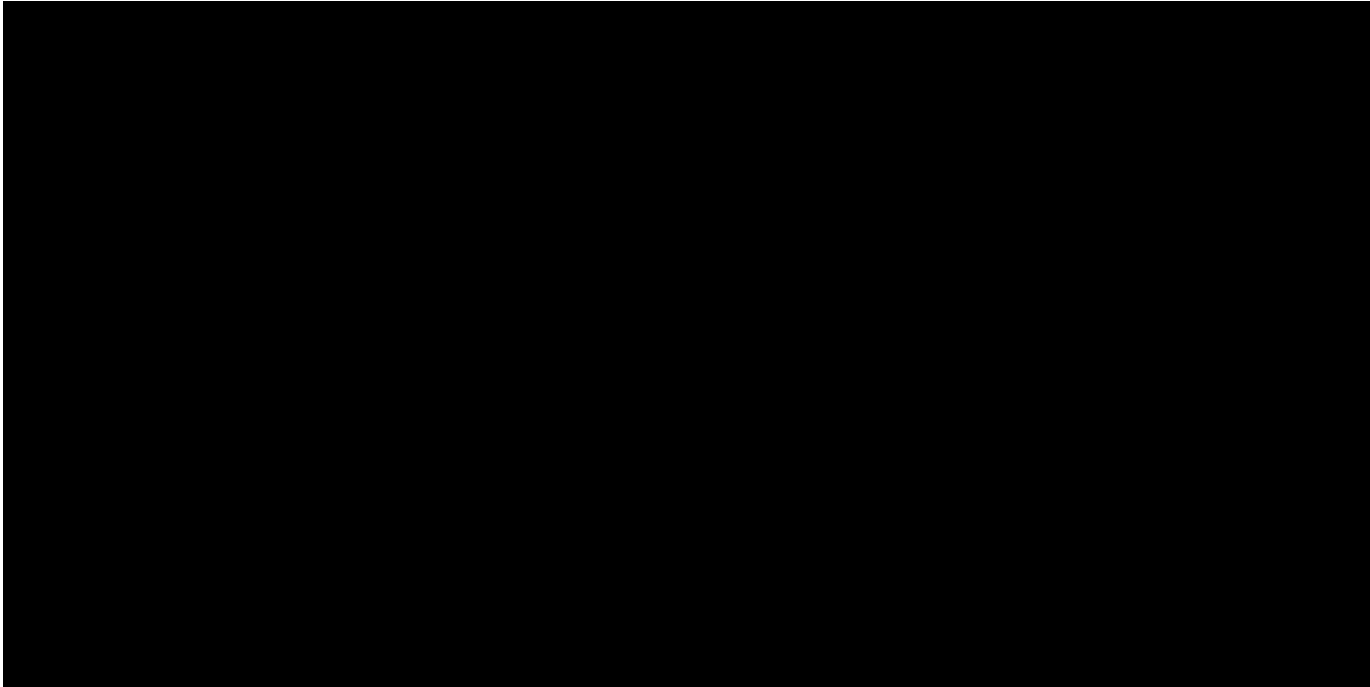

green



blue

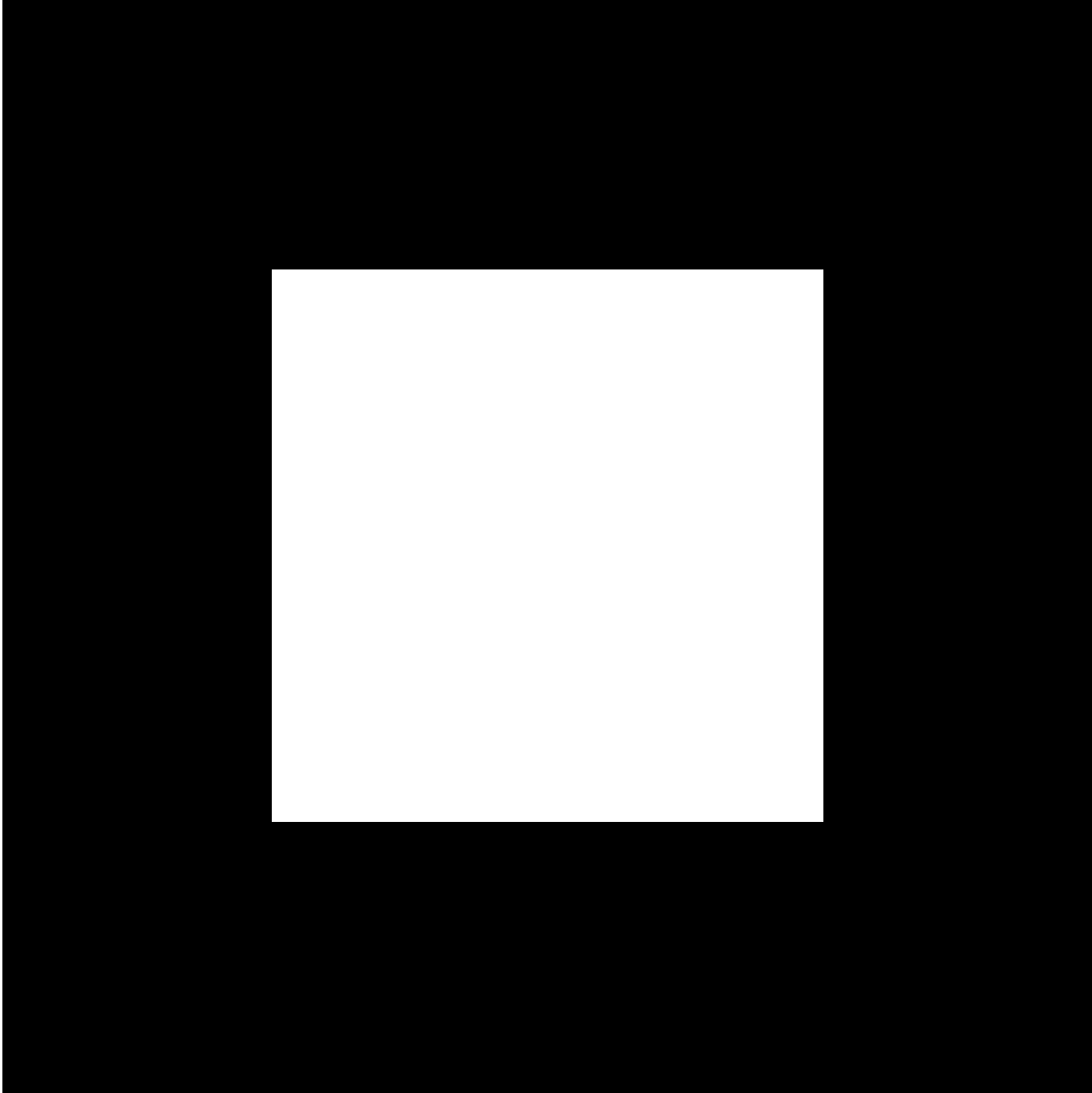

rgb

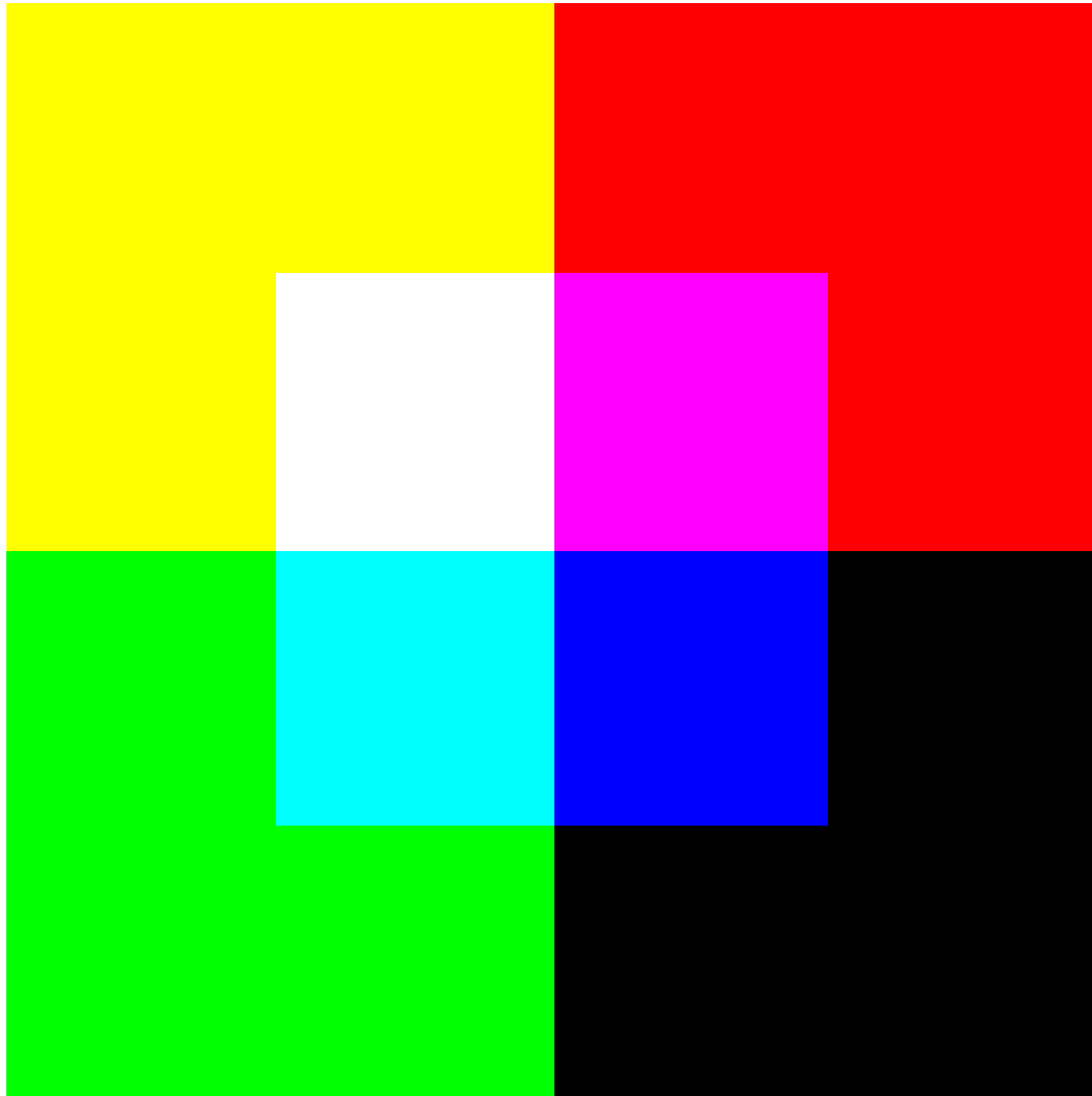

red

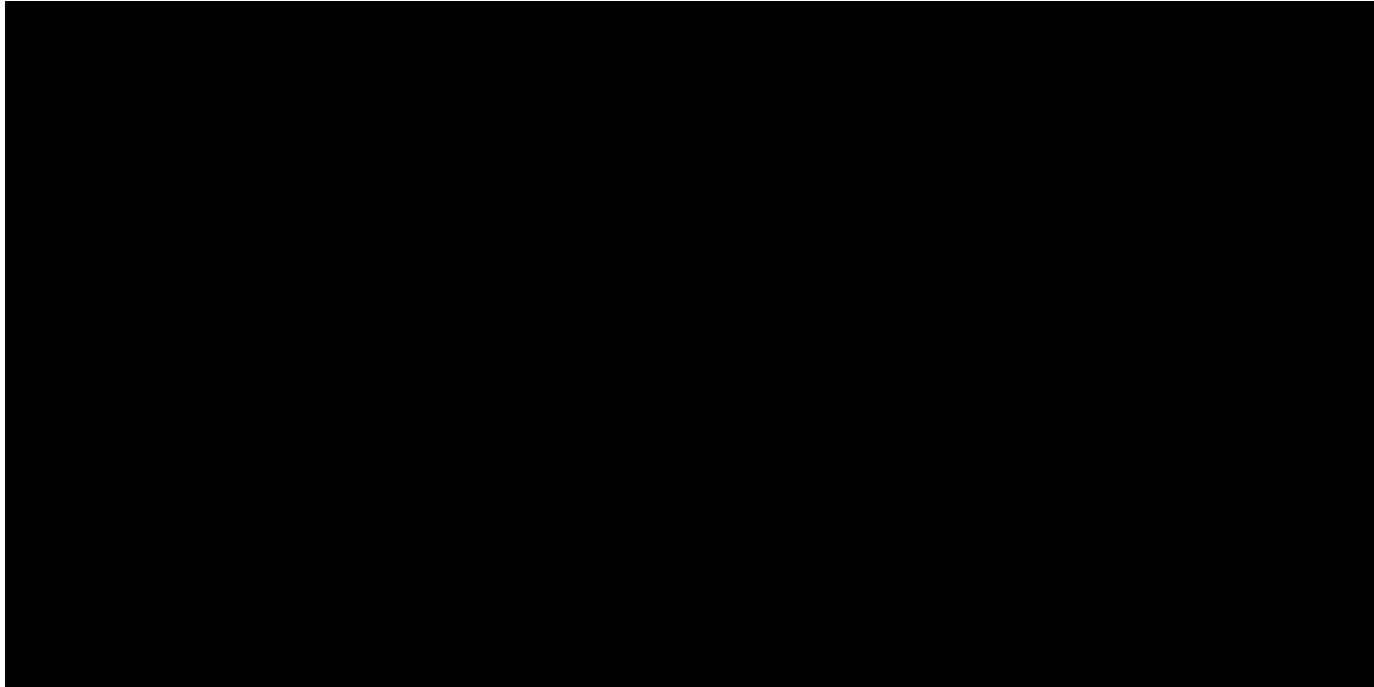

green



blue

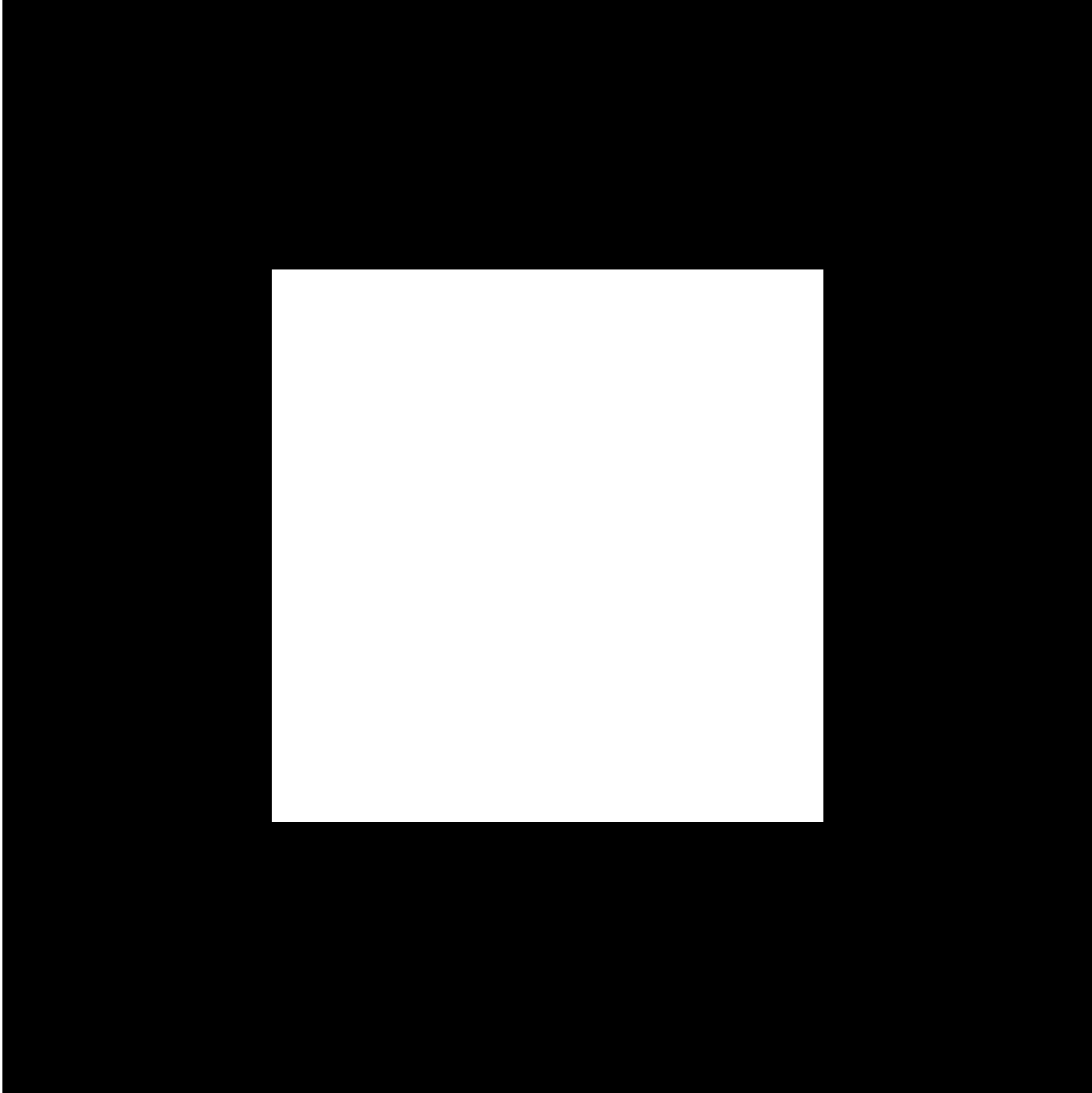

rgb

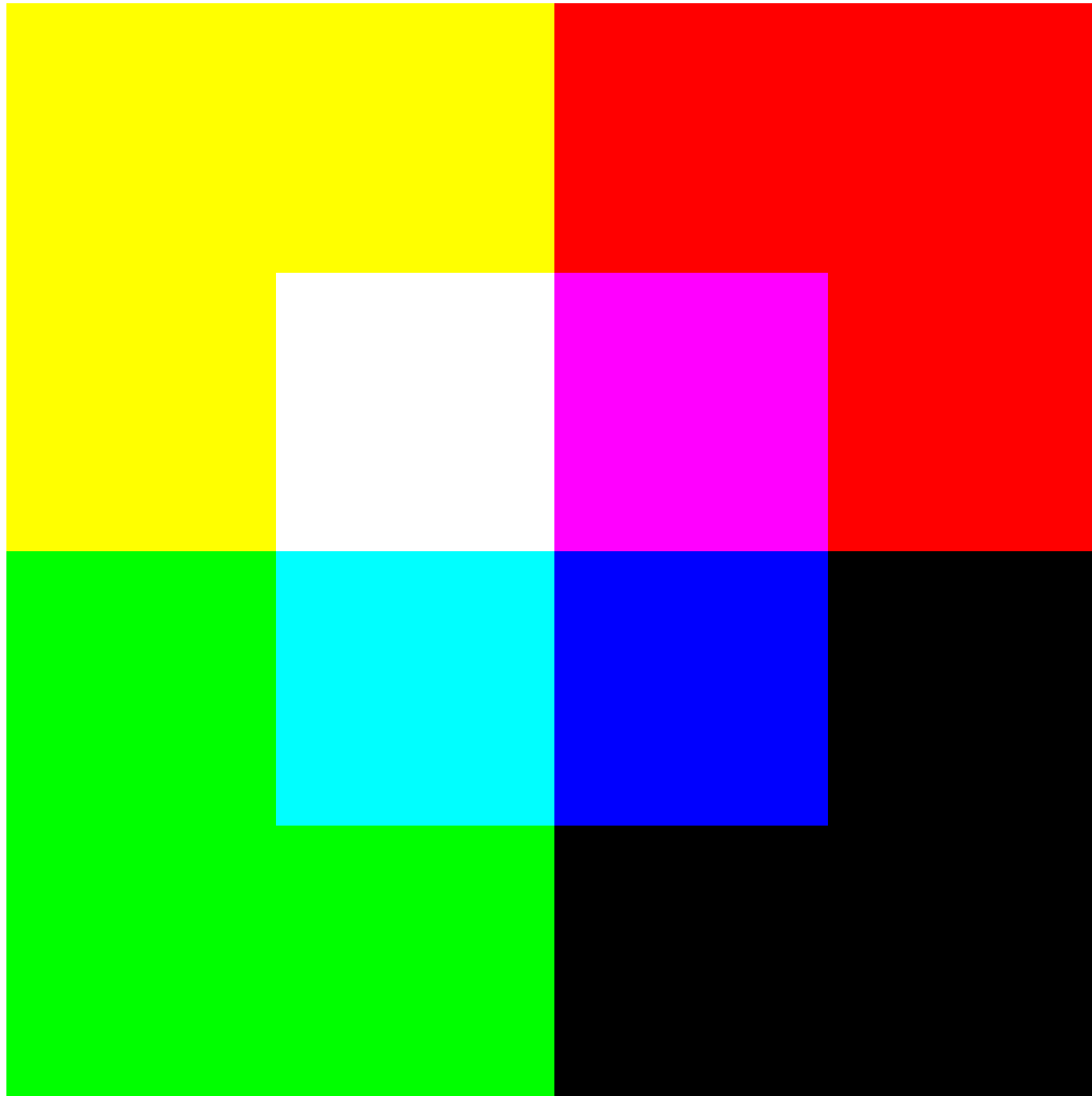

red

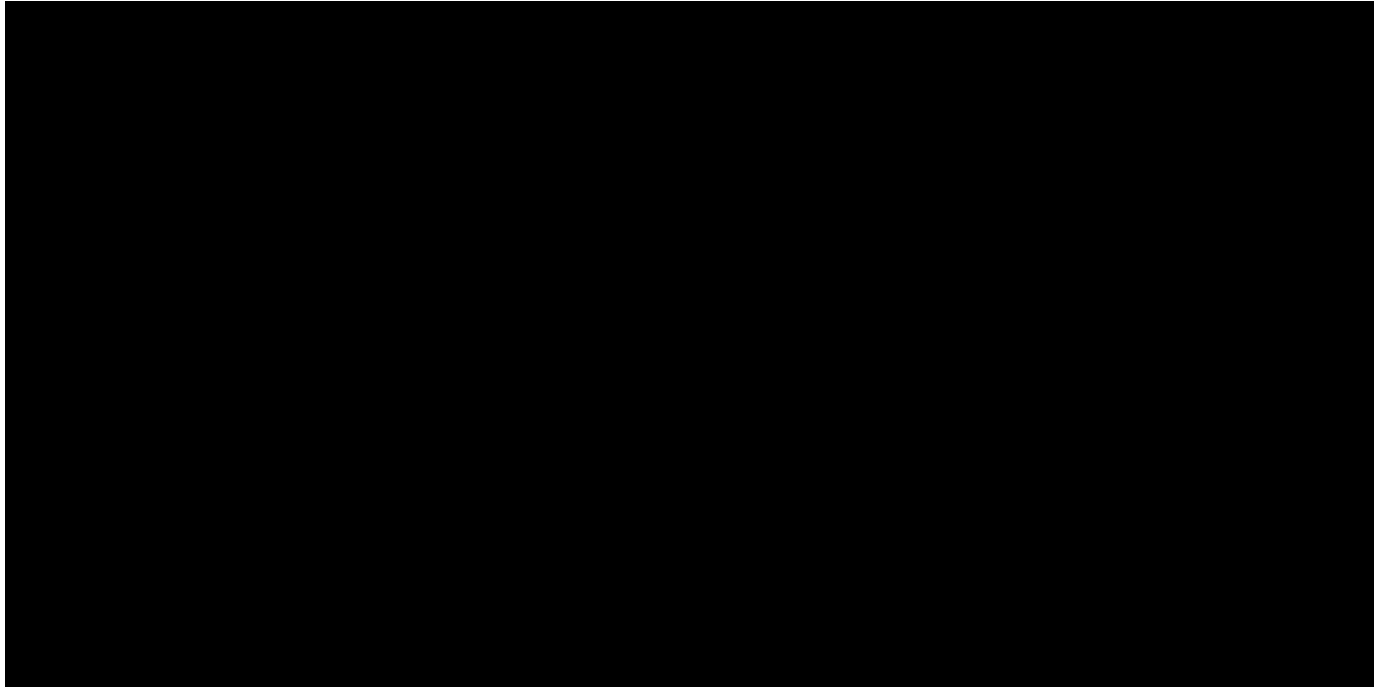

green



blue

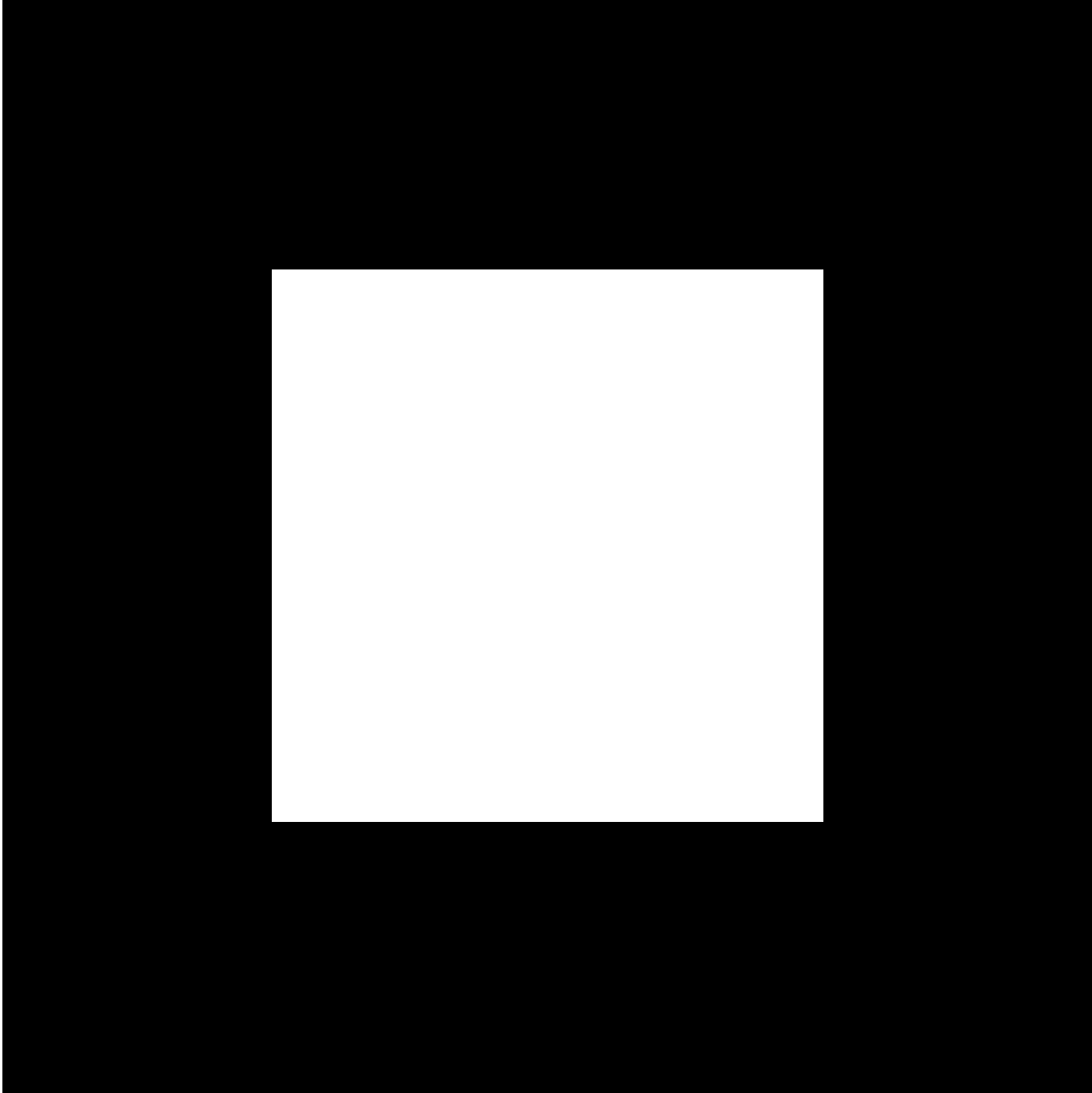

rgb

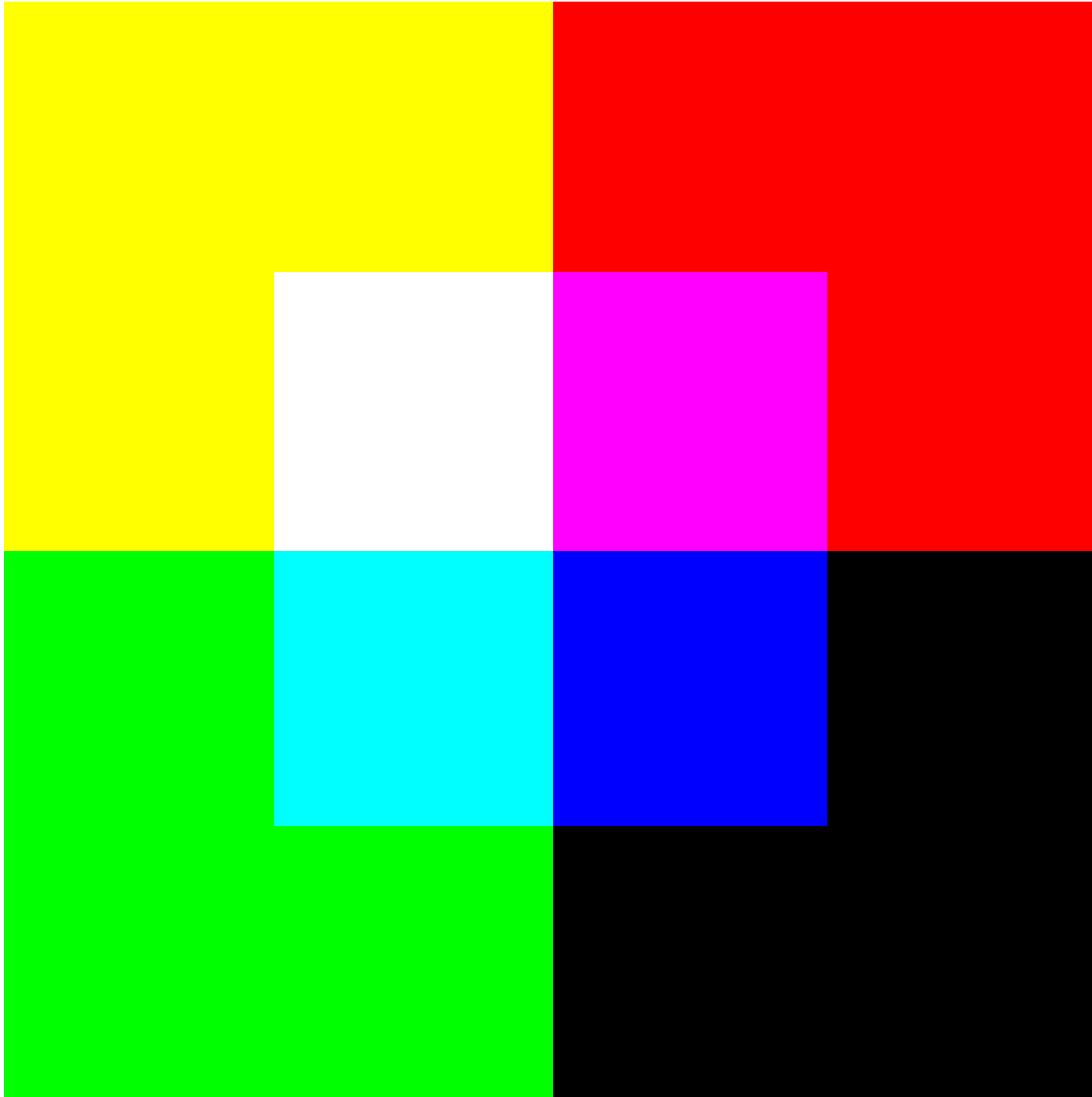

red

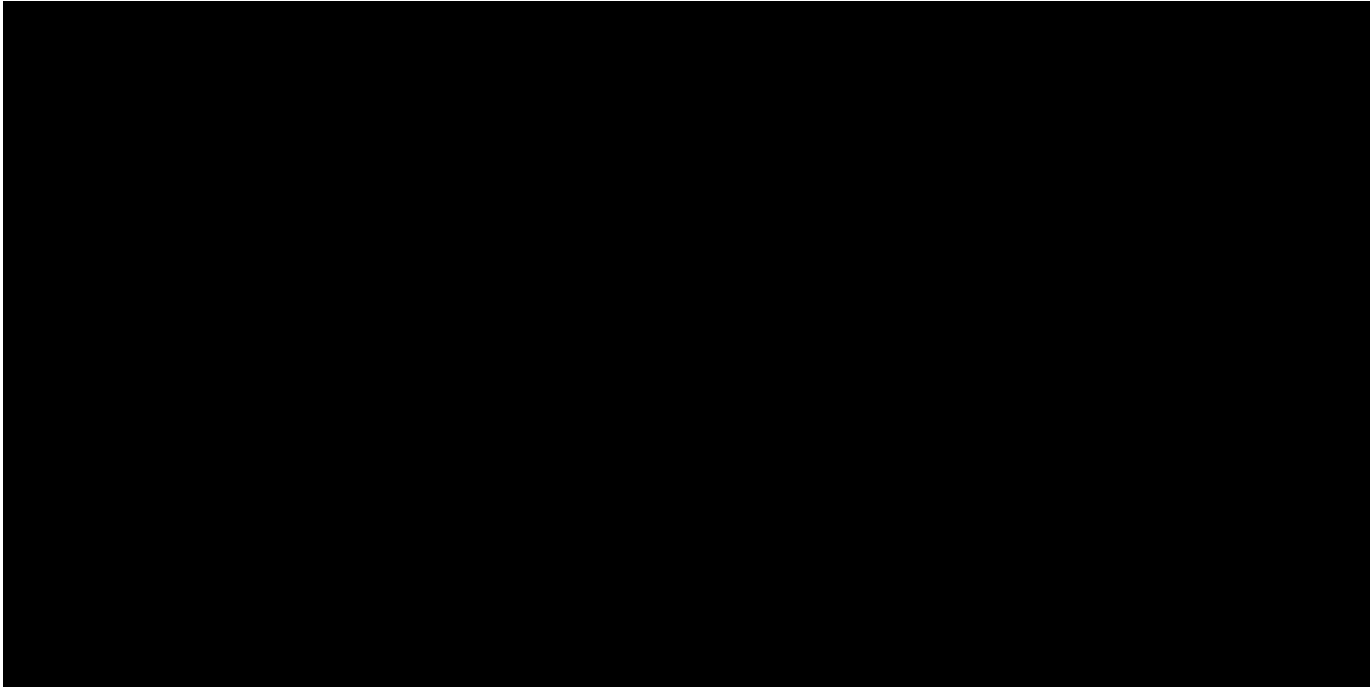

green



blue

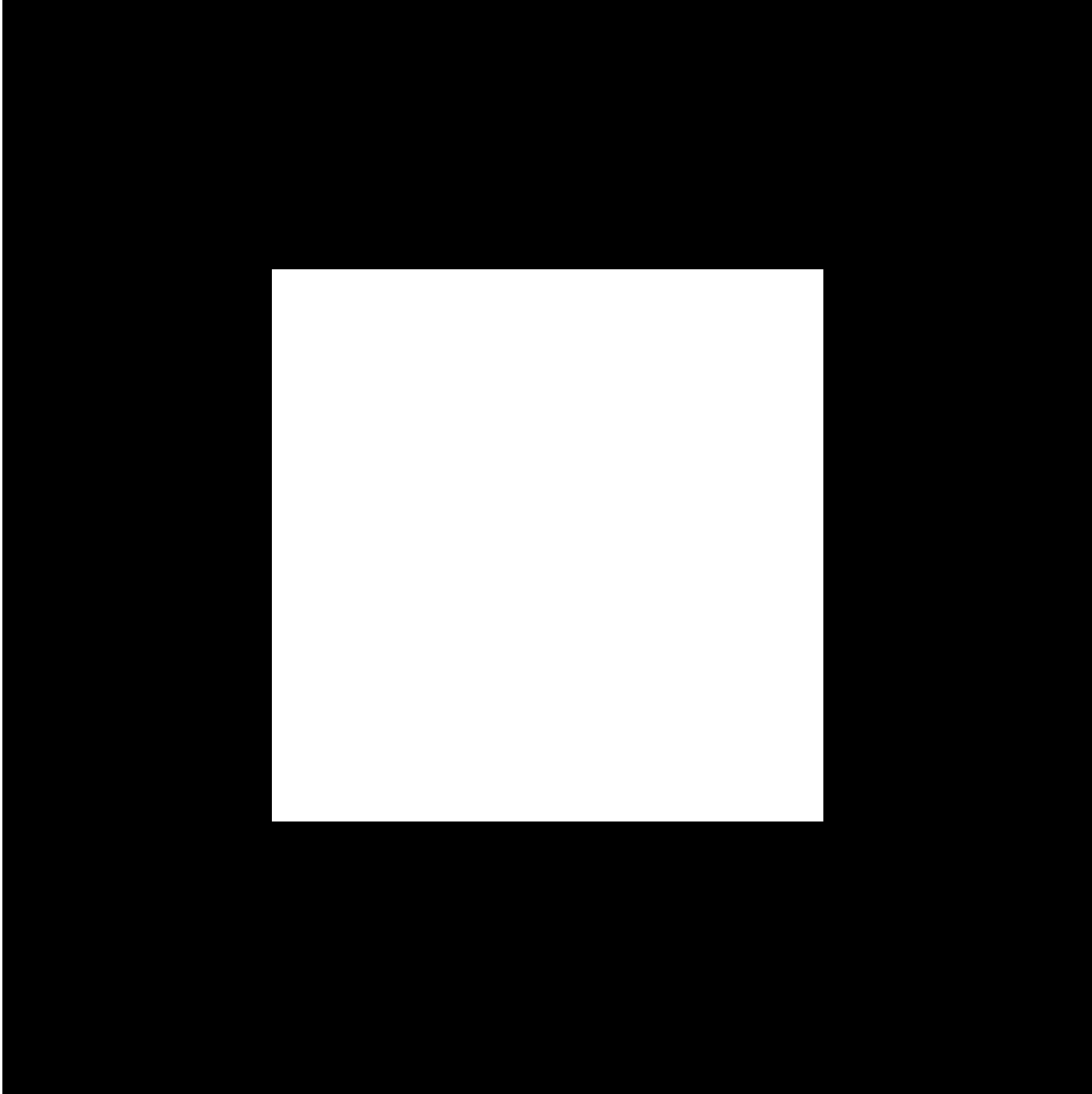

rgb

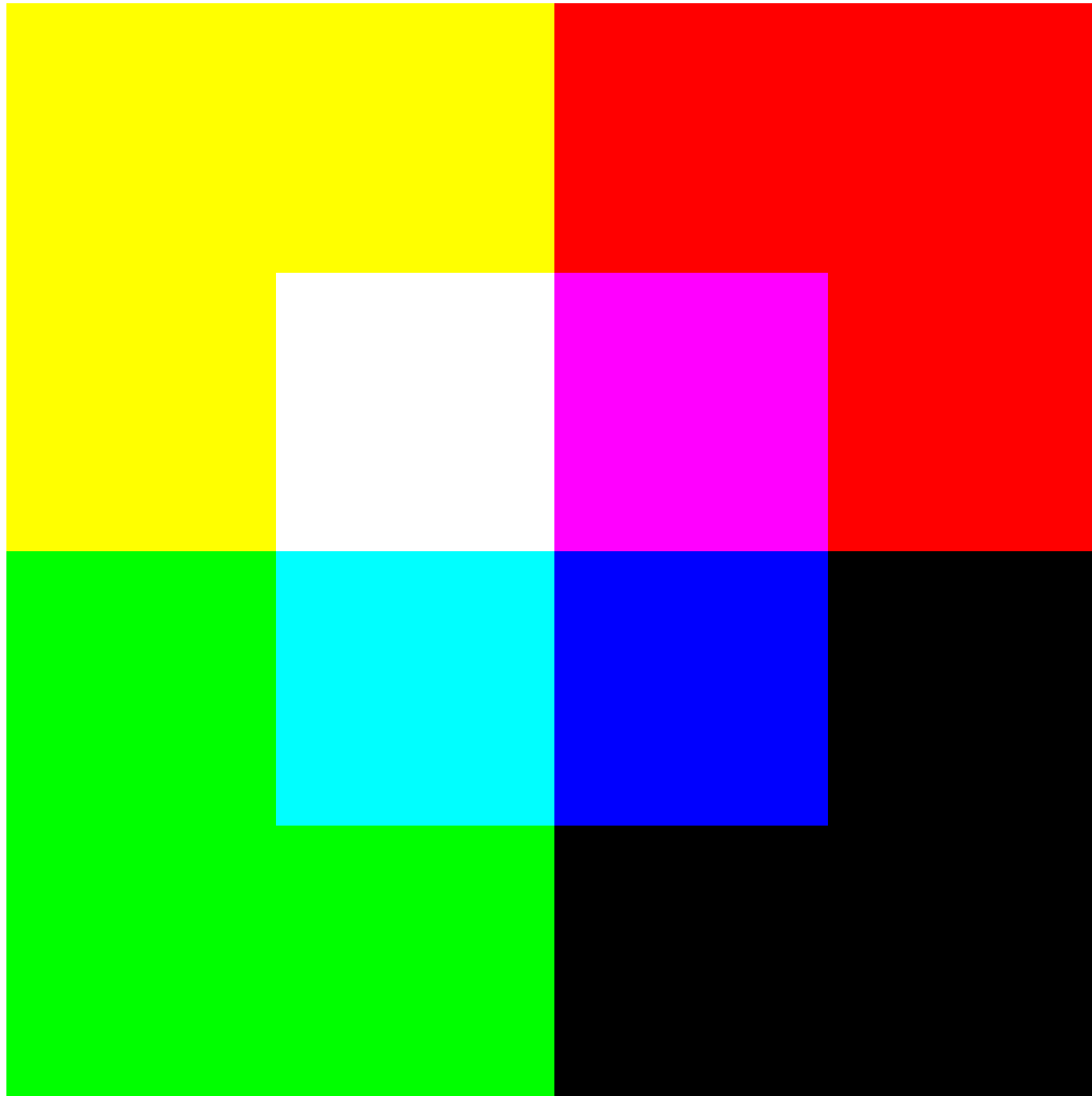

red

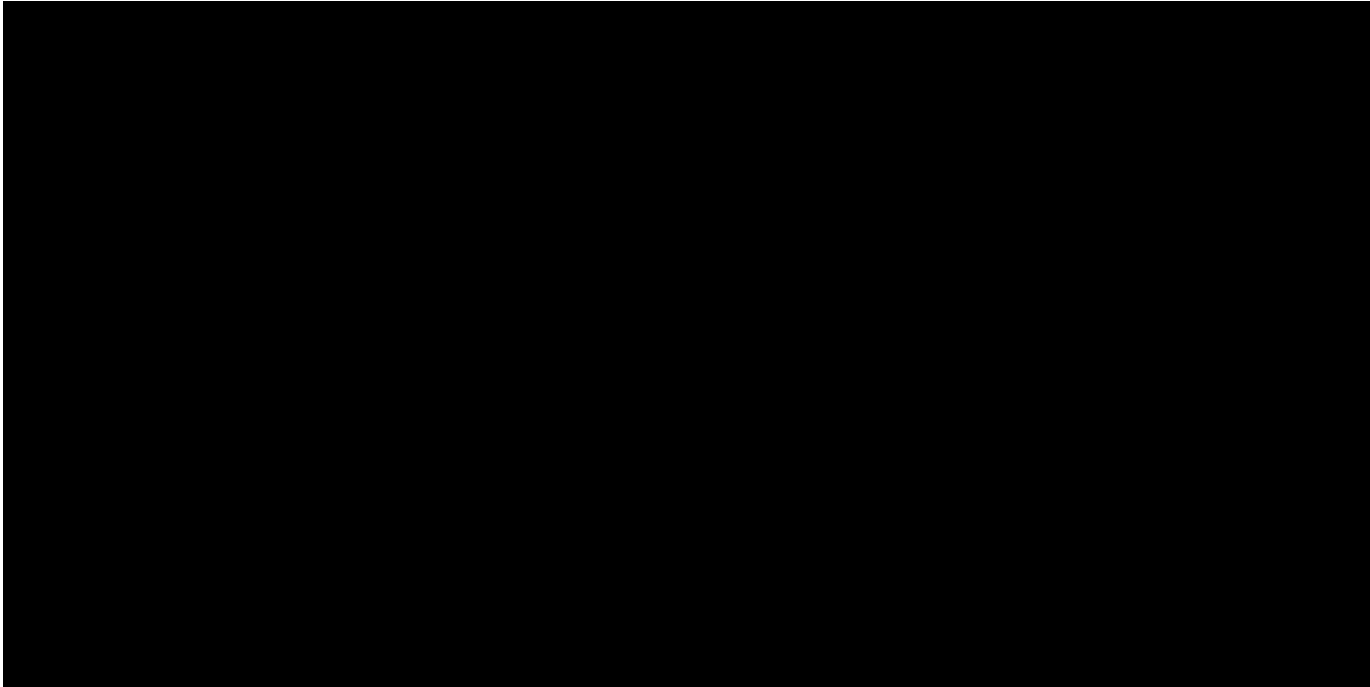

green



blue

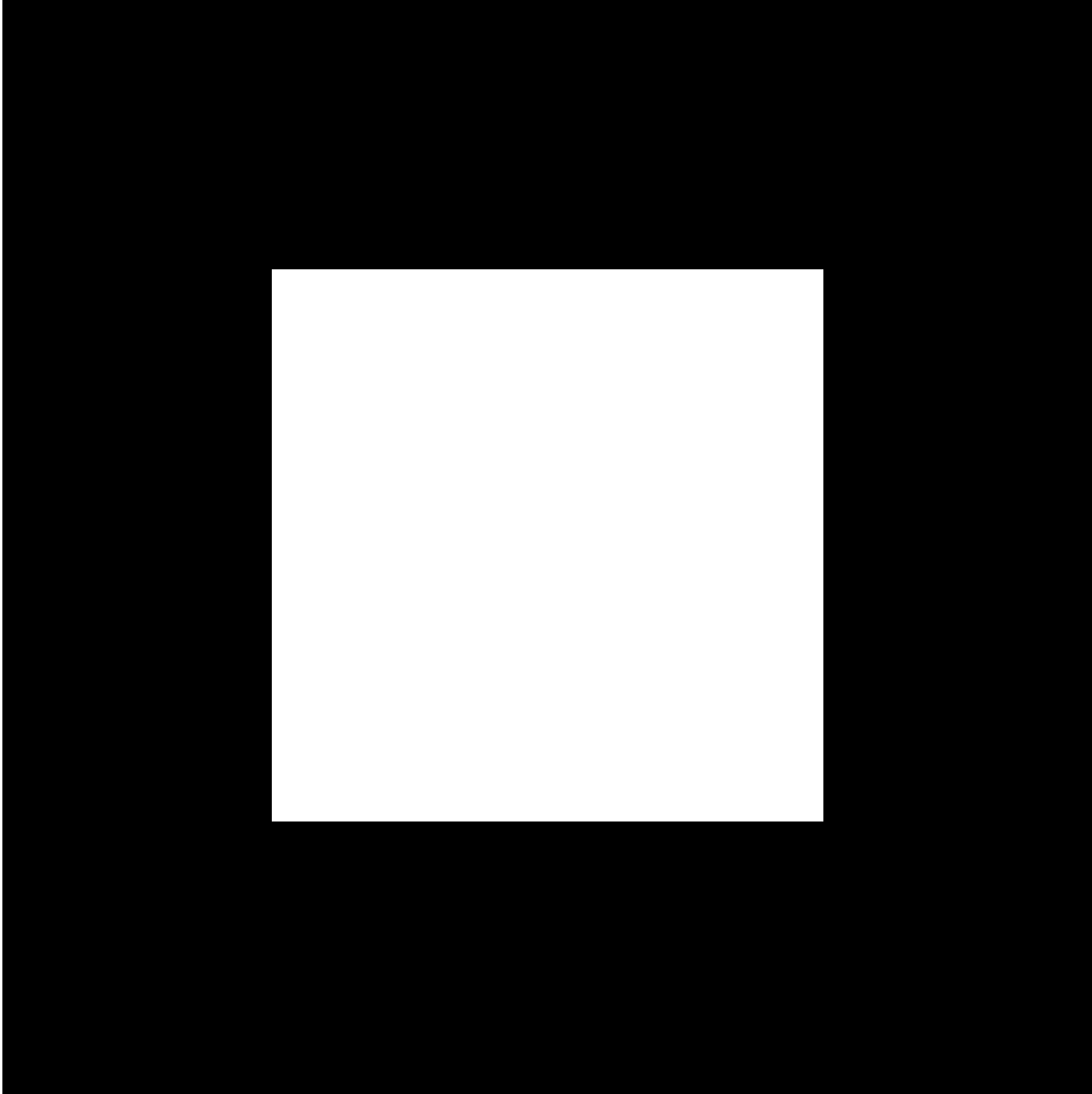

rgb

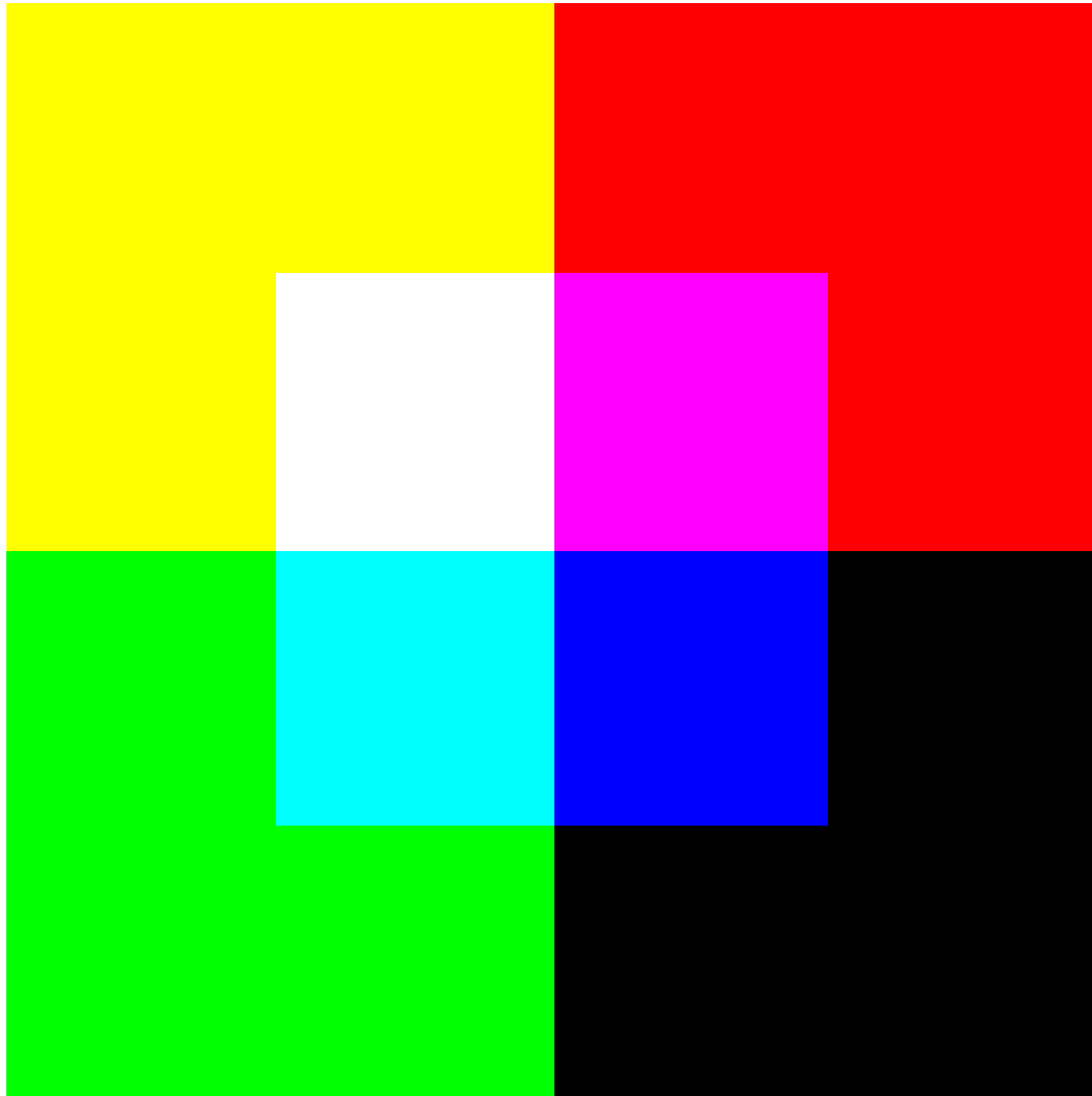

red

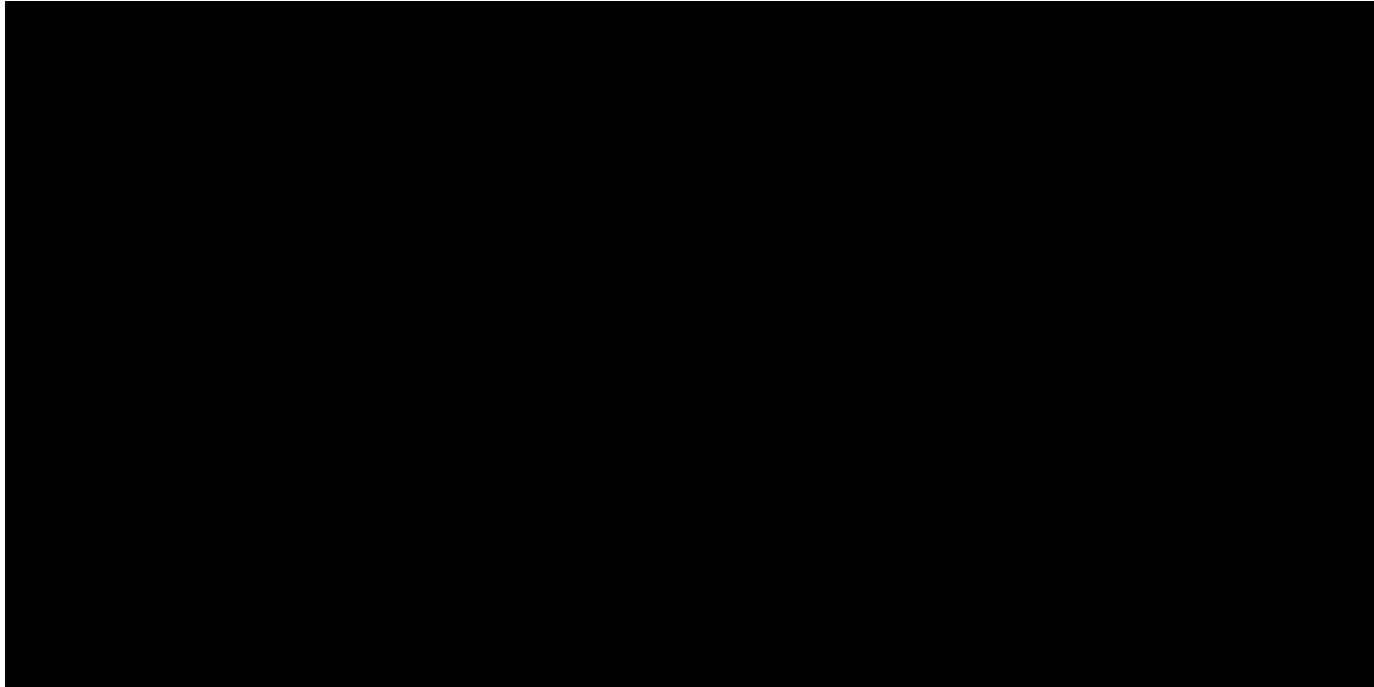

green



blue

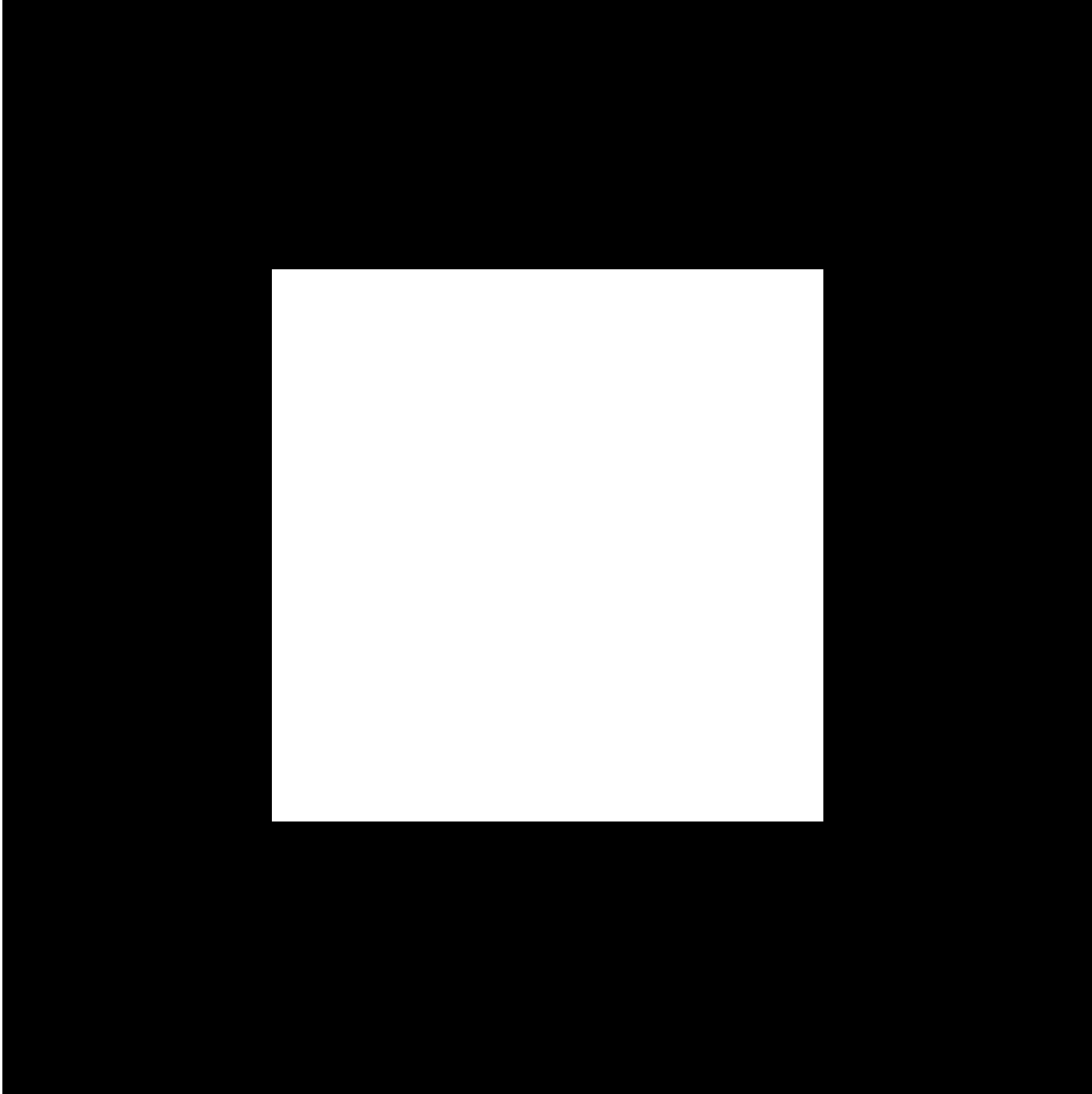

rgb

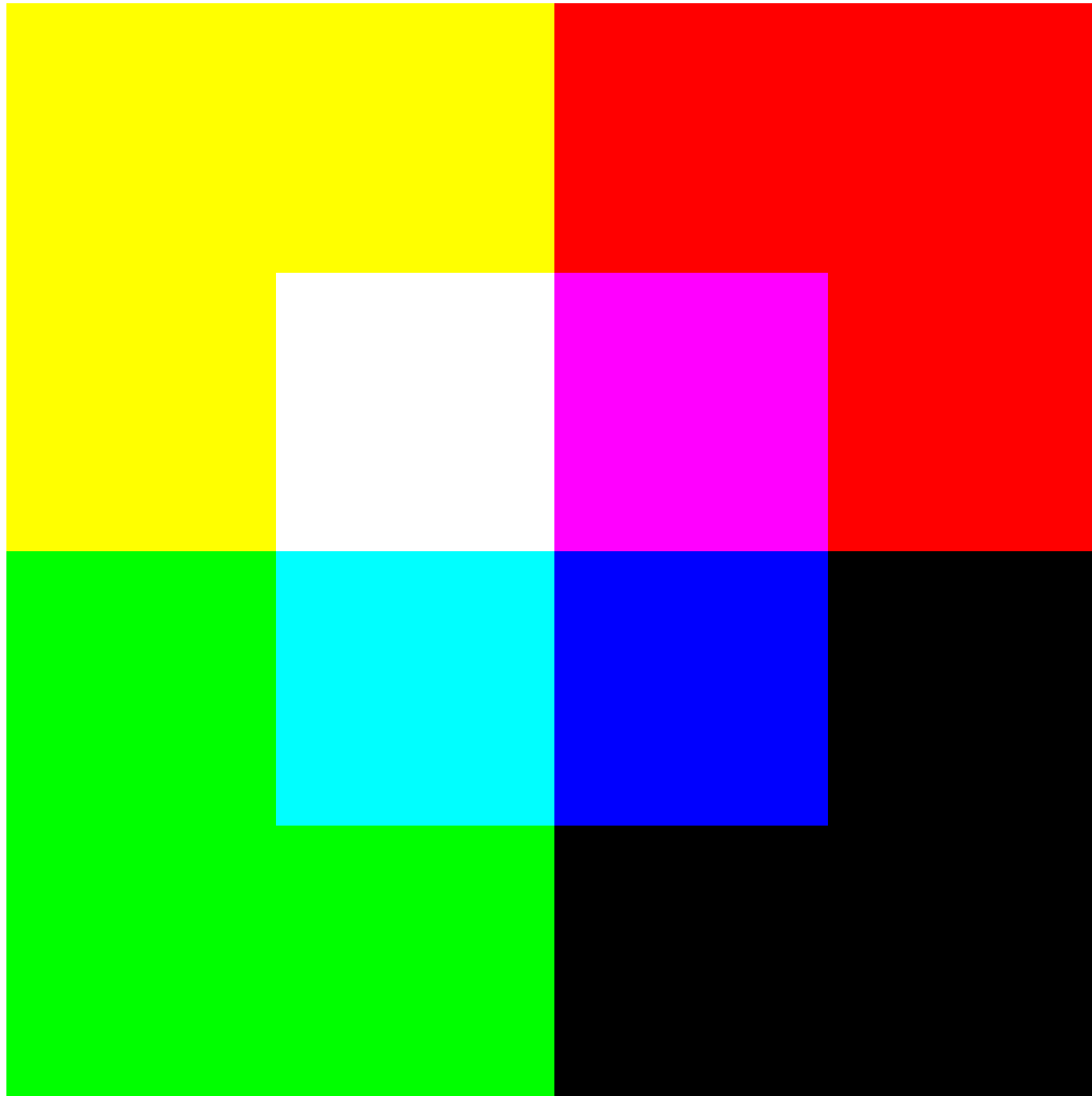

red

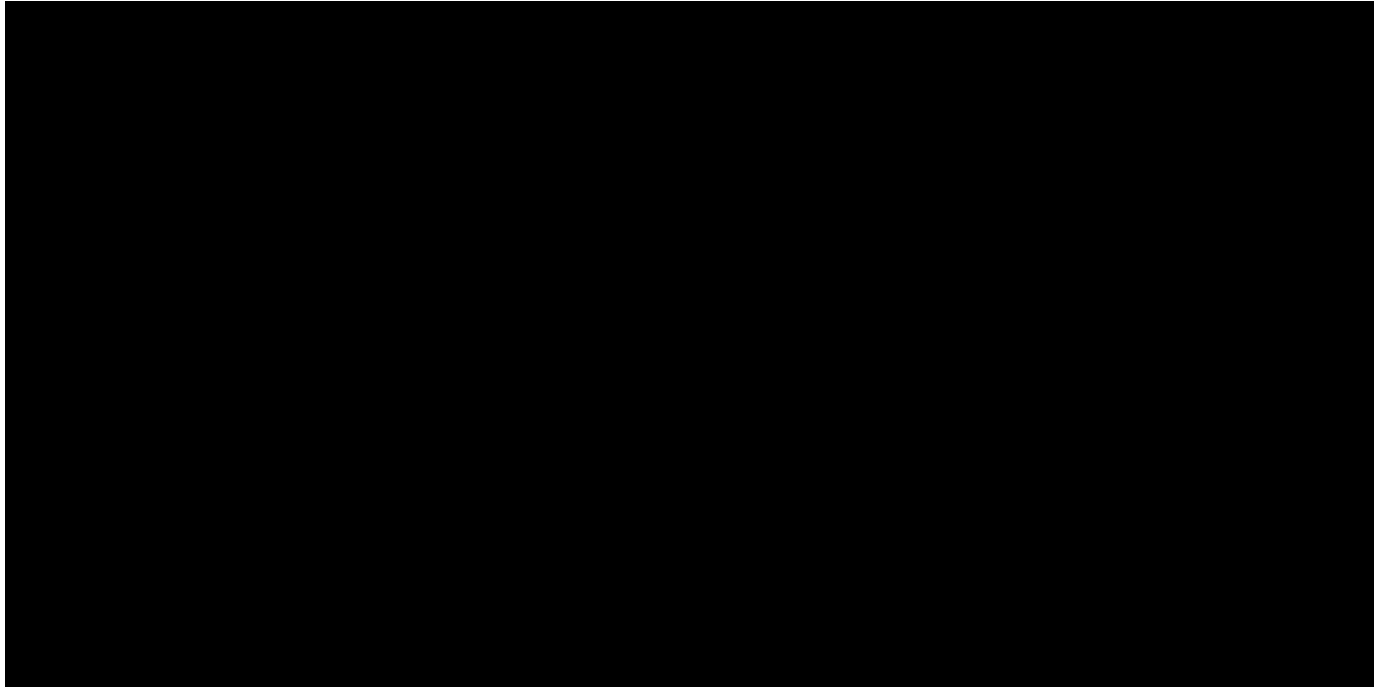

green



rg

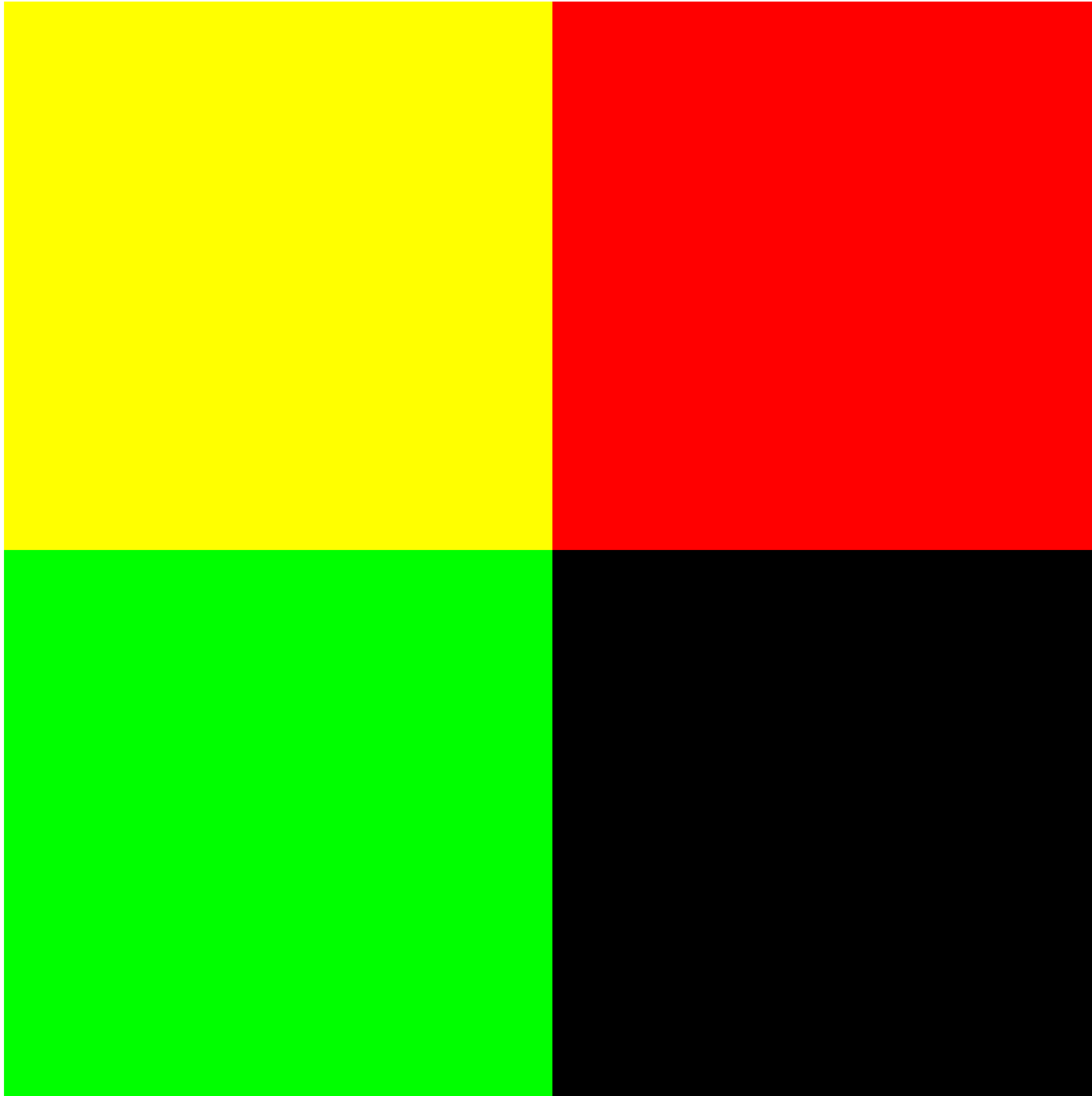

red

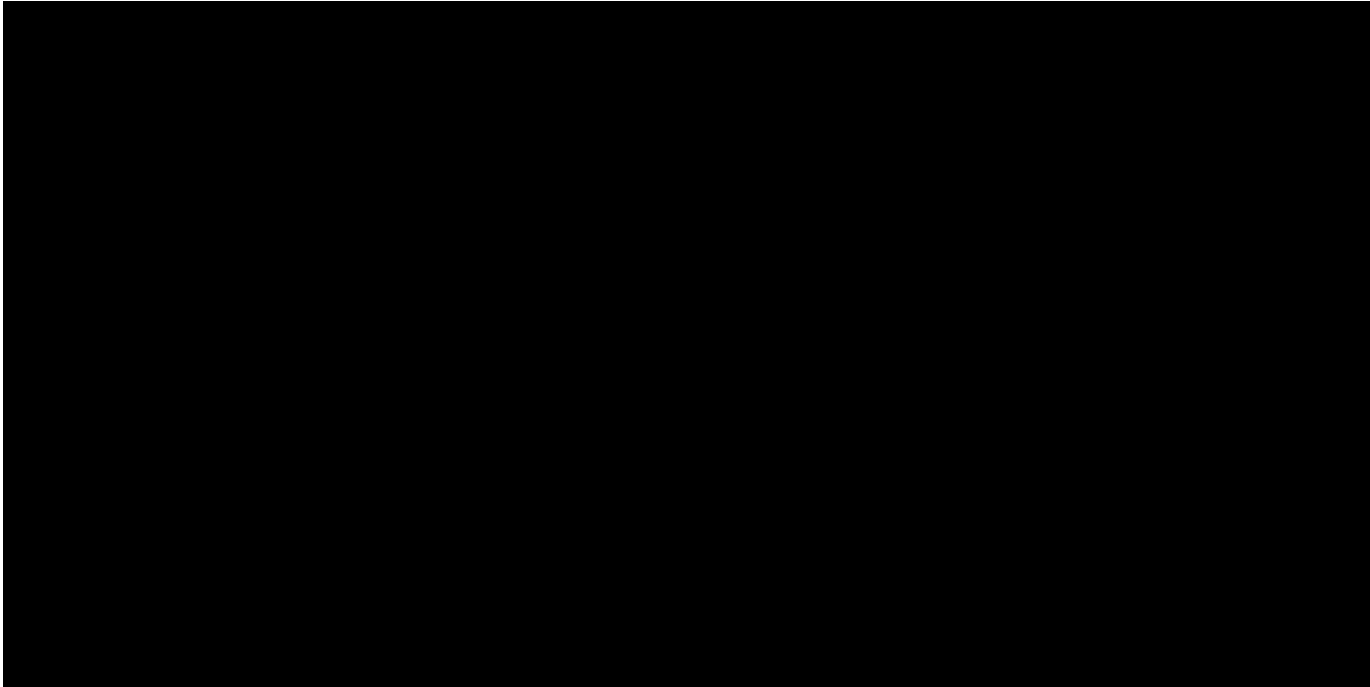

blue

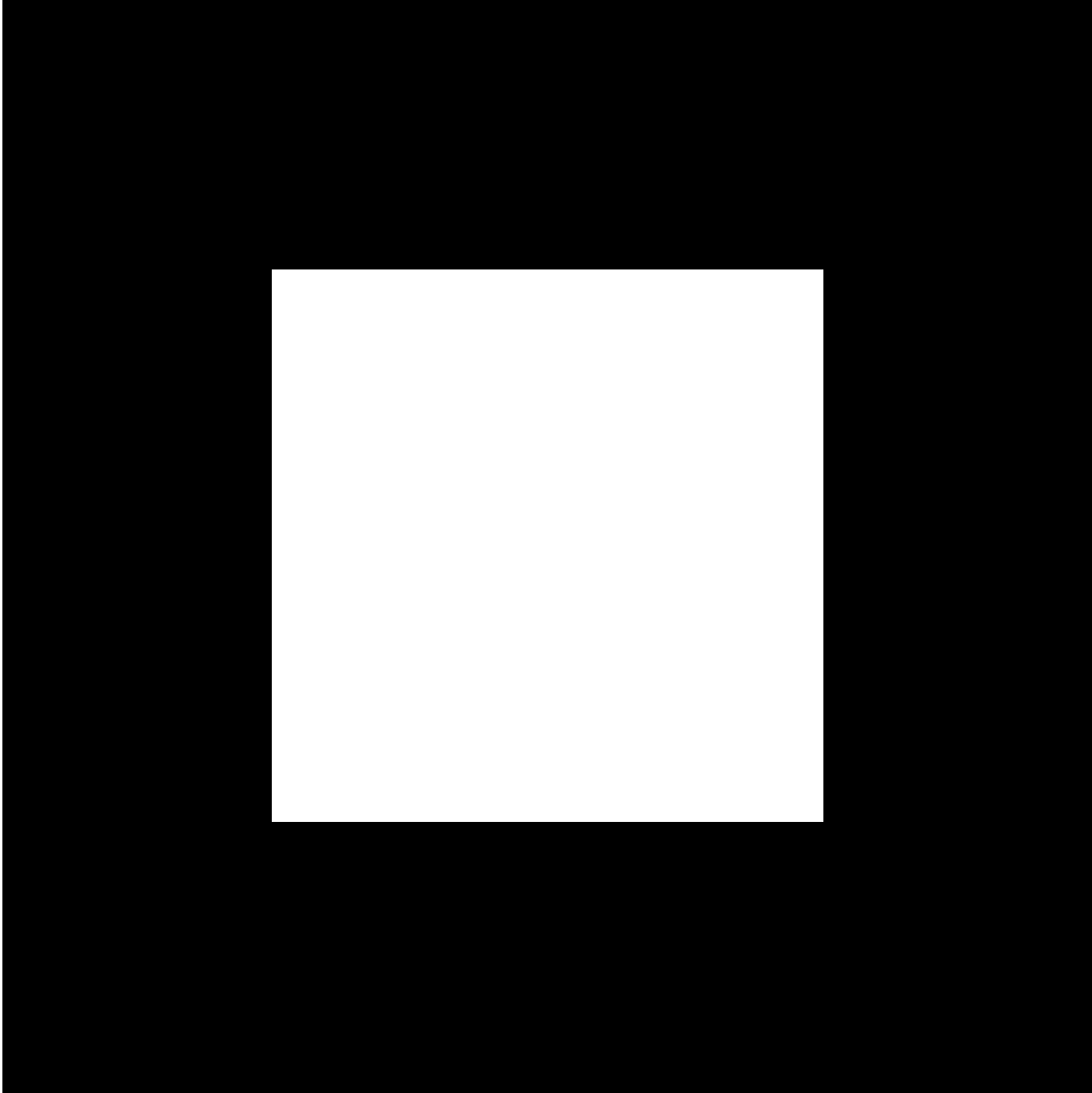

rb

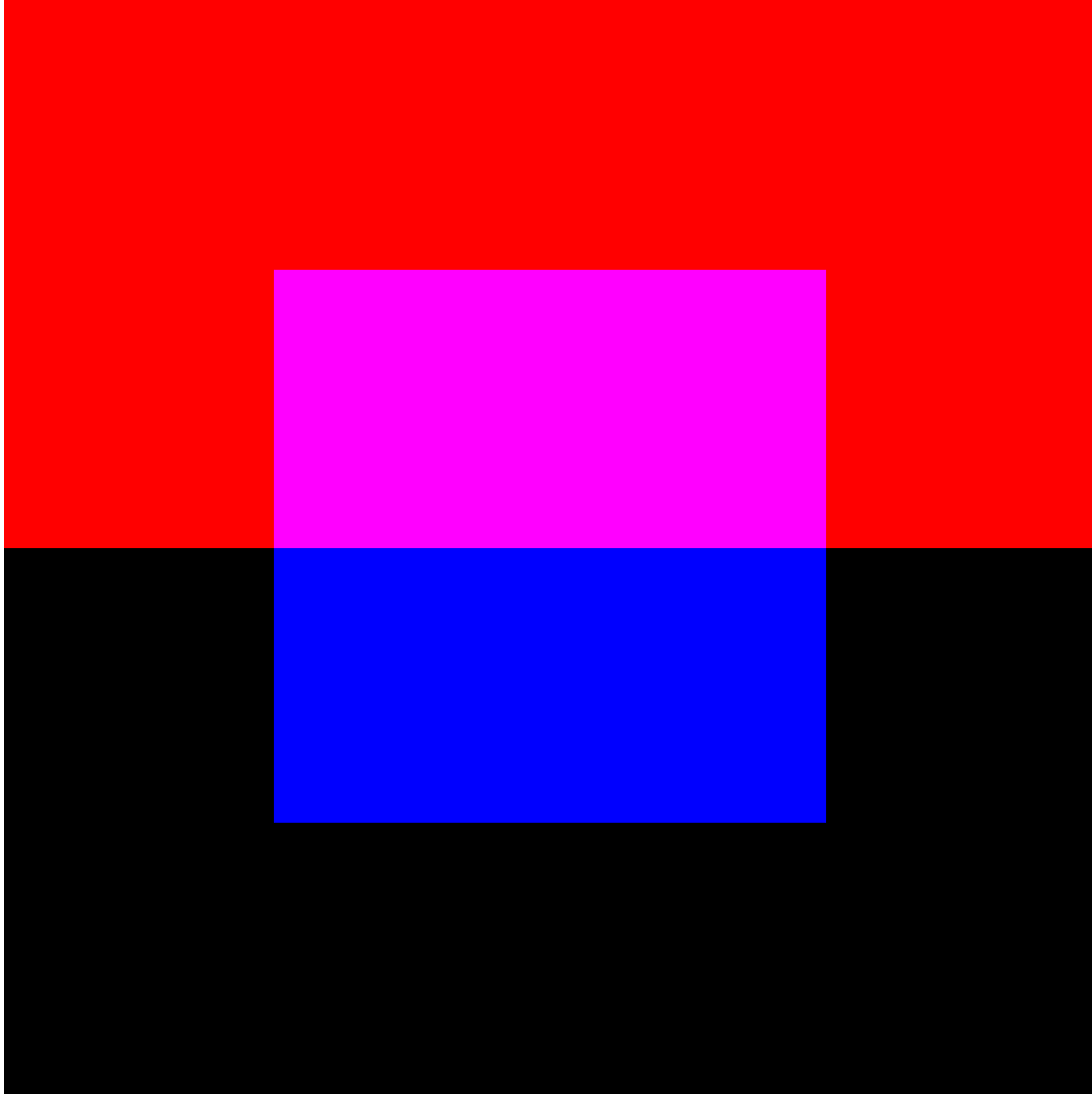

green

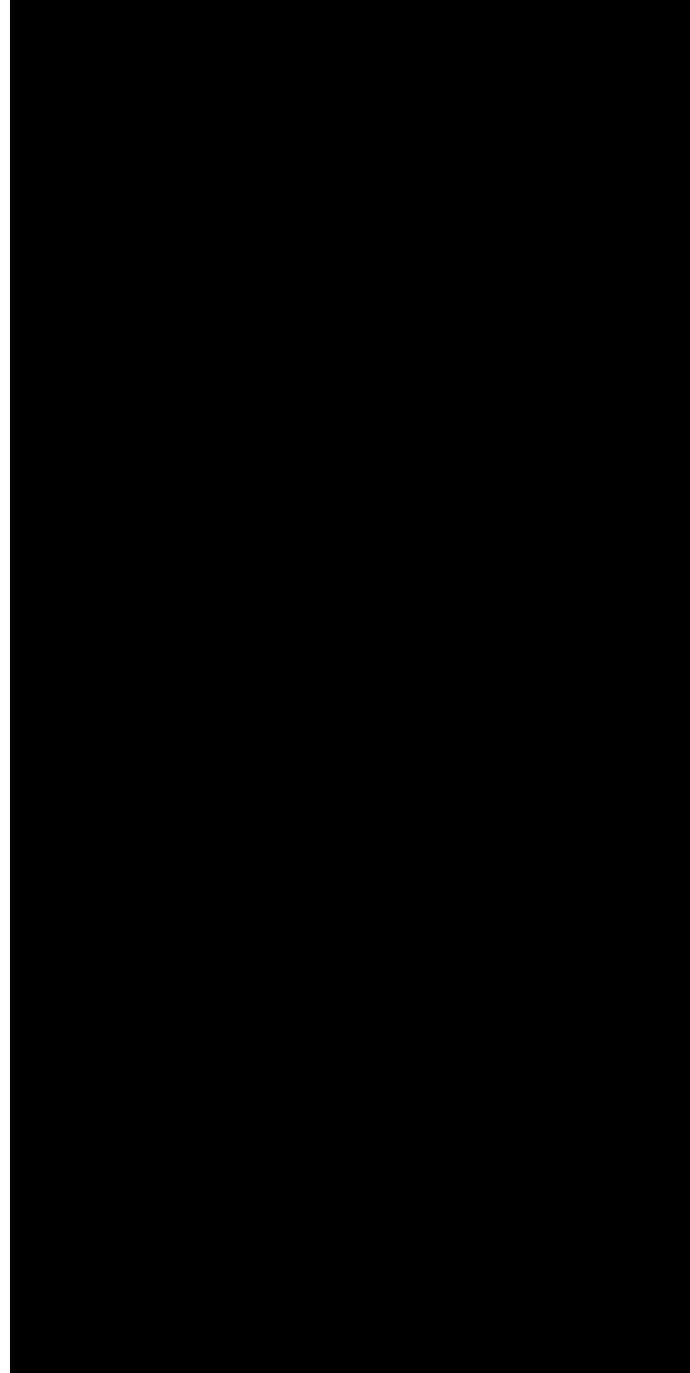

blue

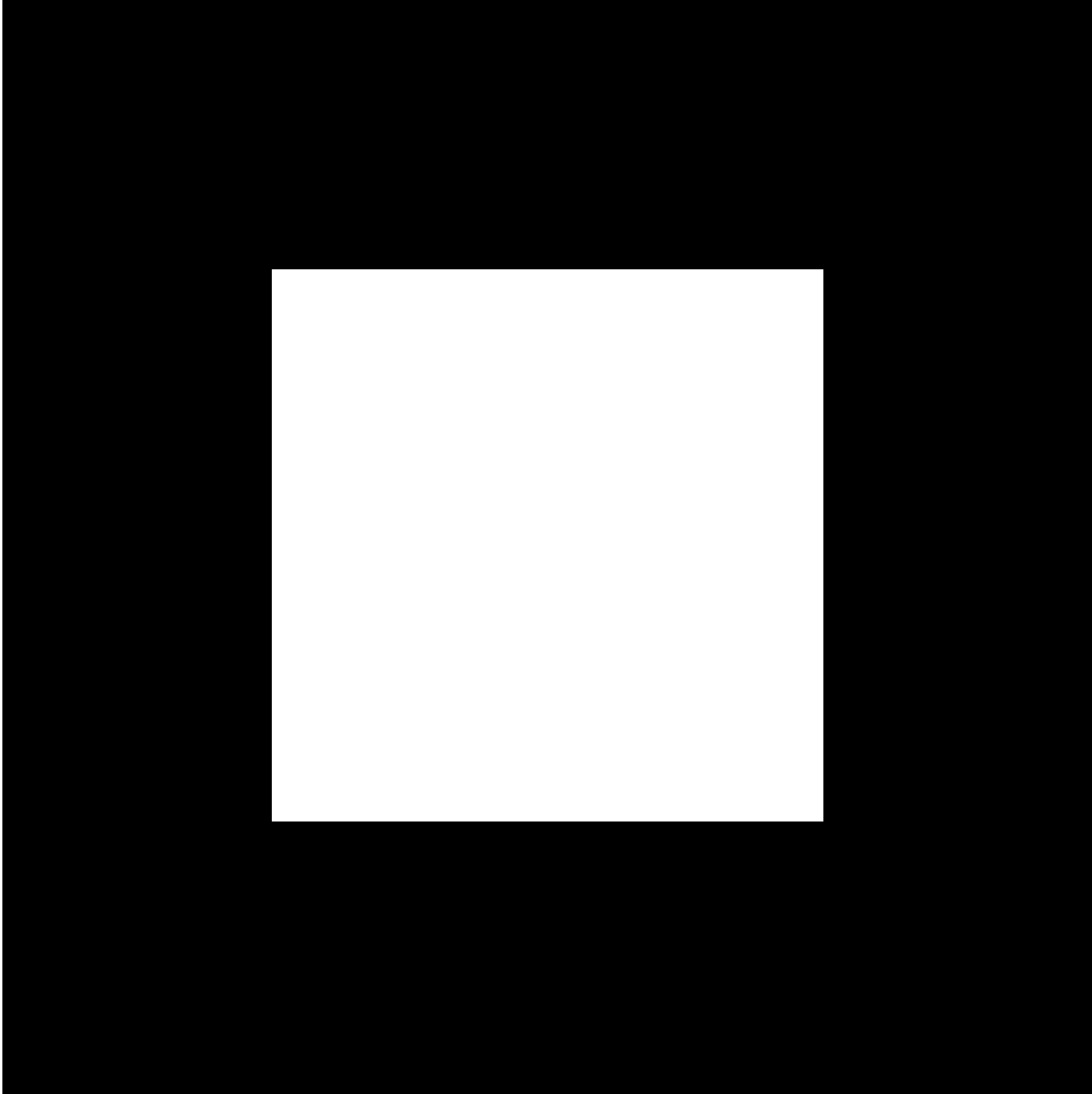

gb

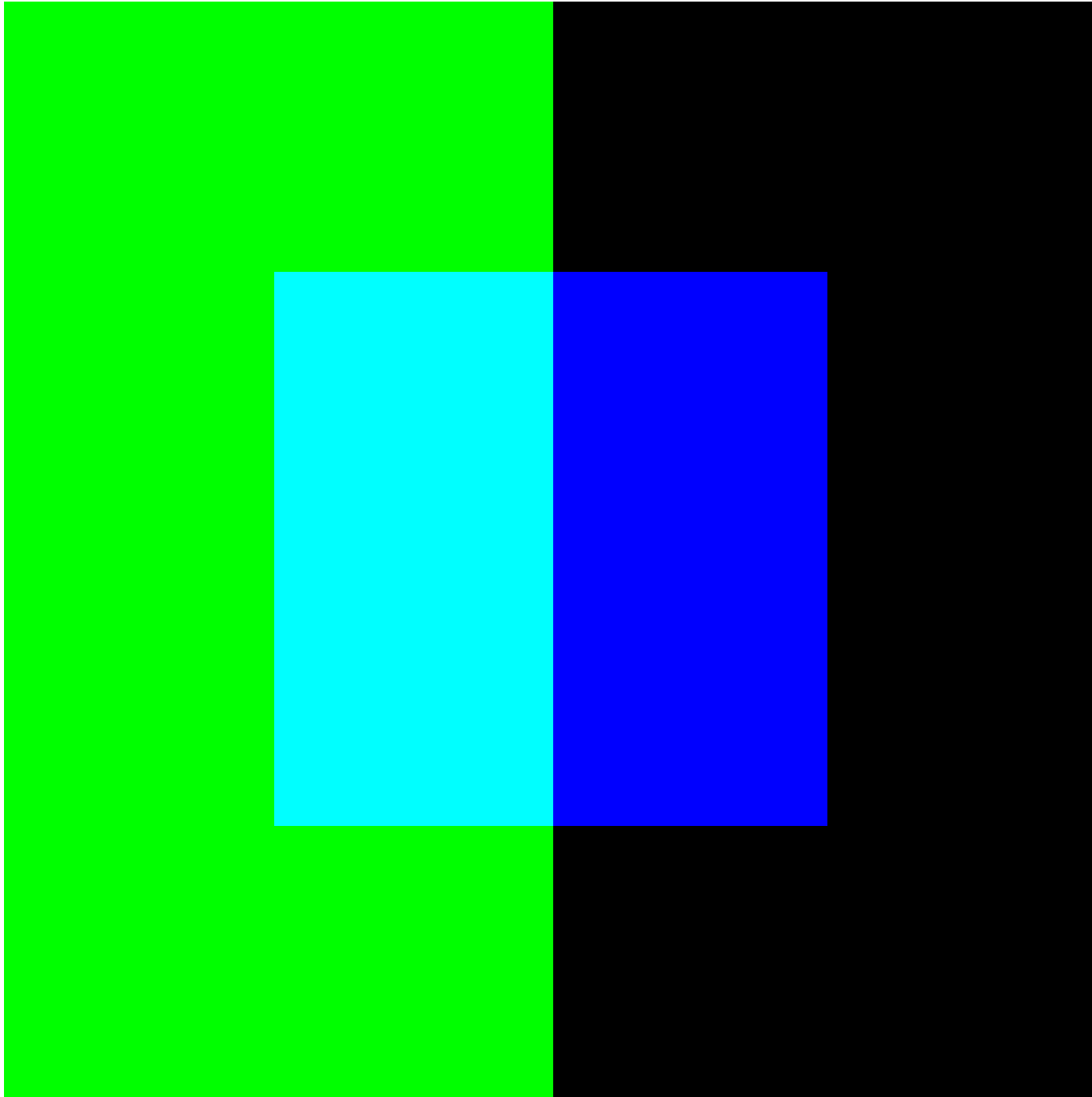

C

M

Y

K

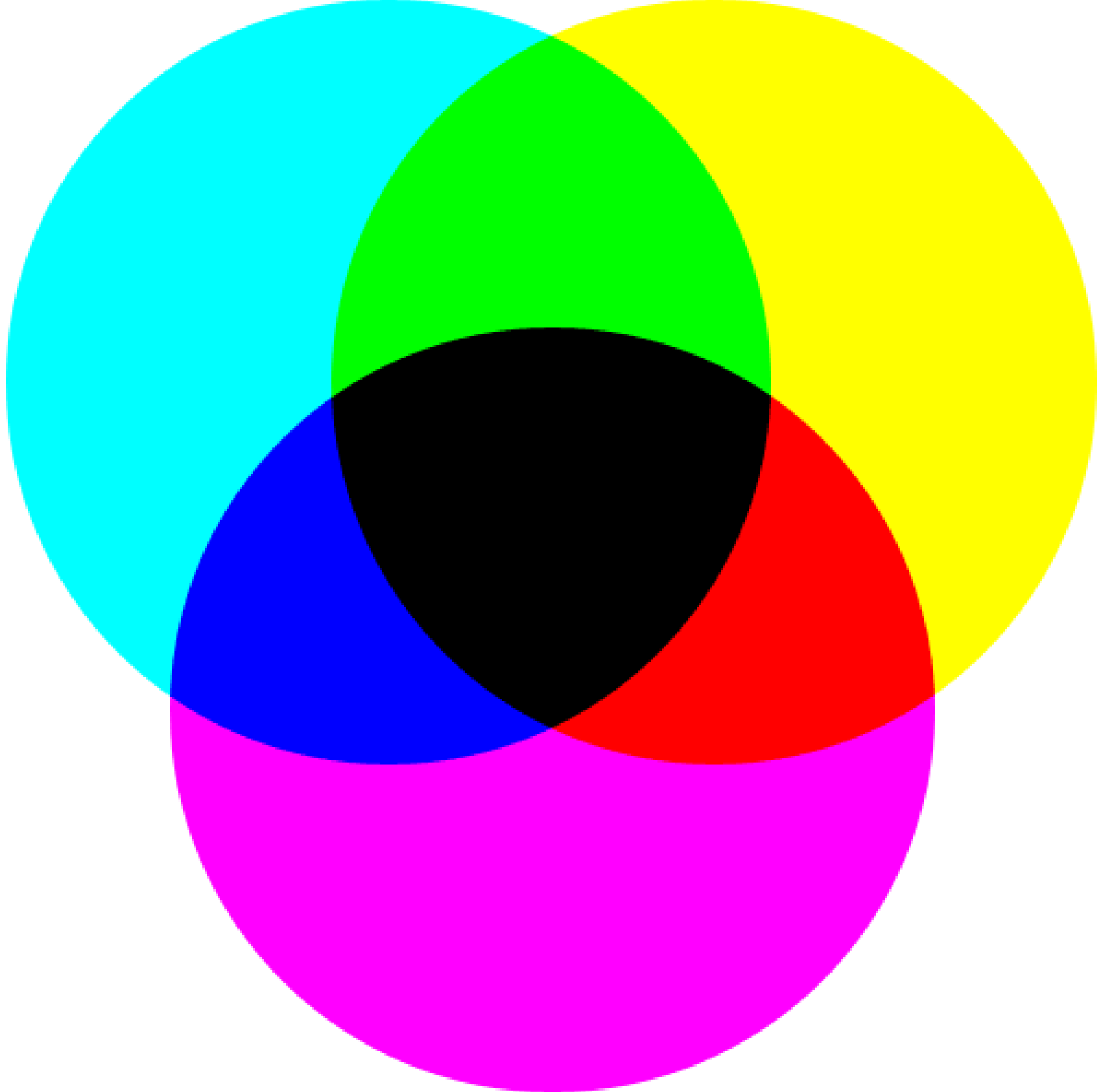

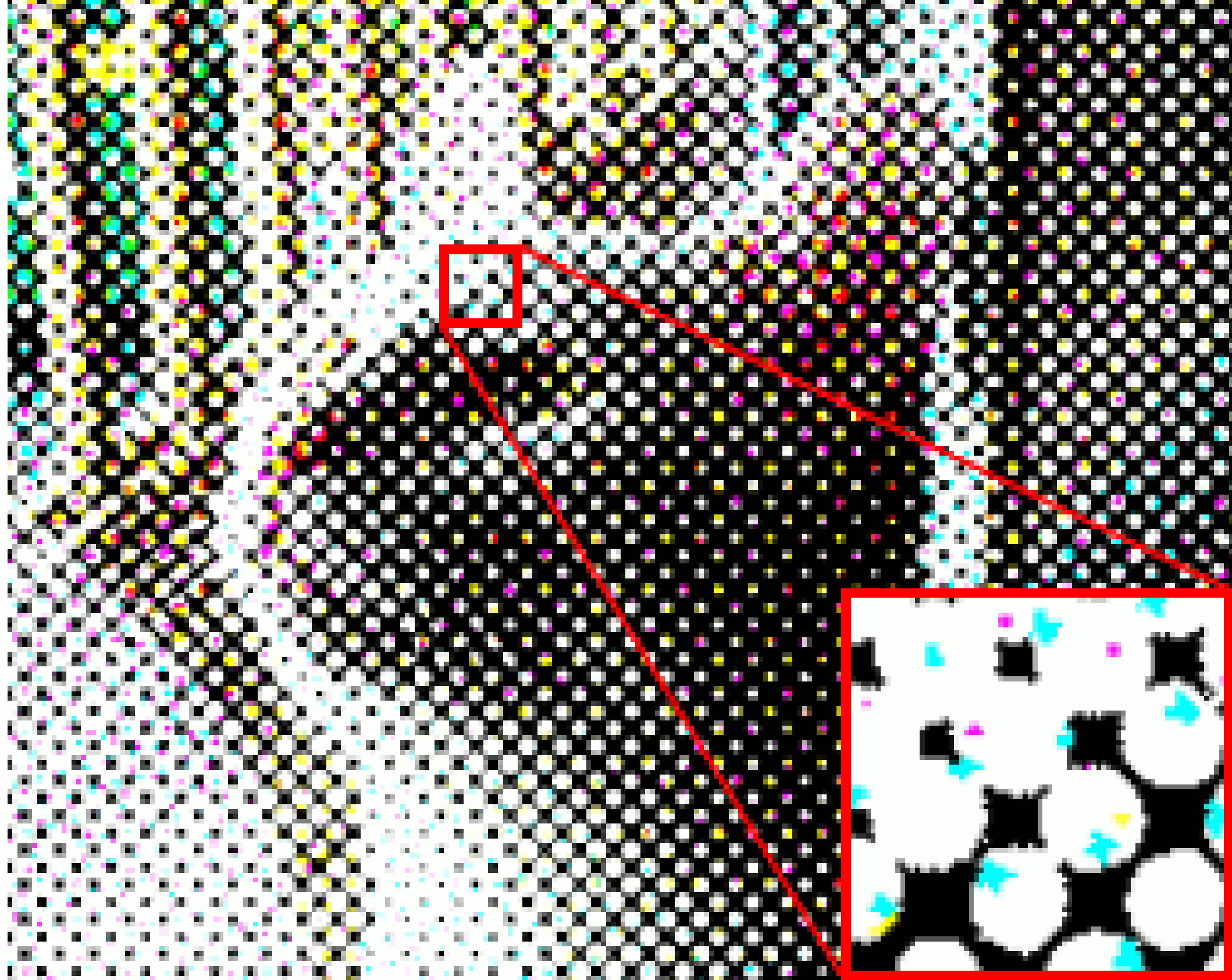

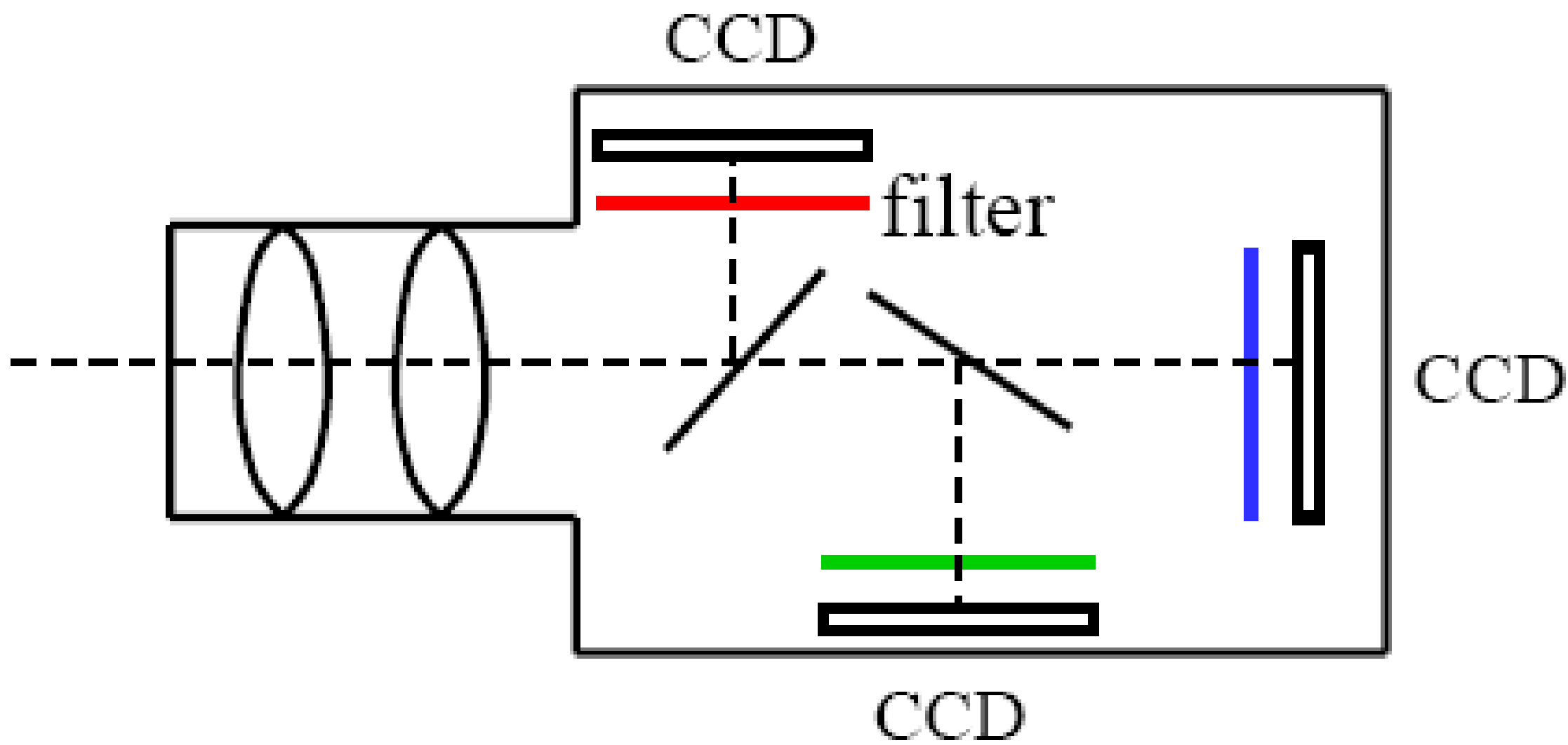

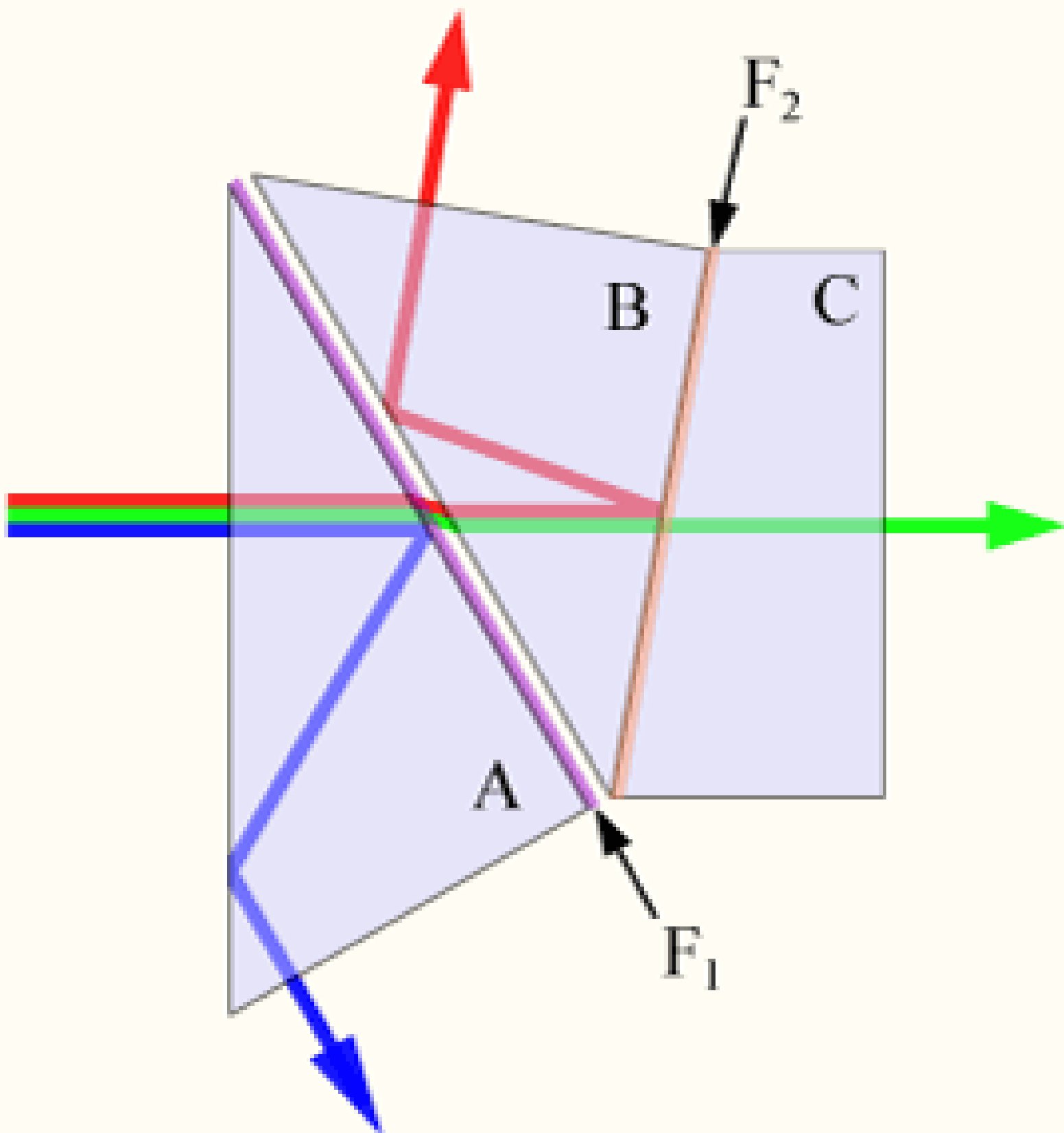

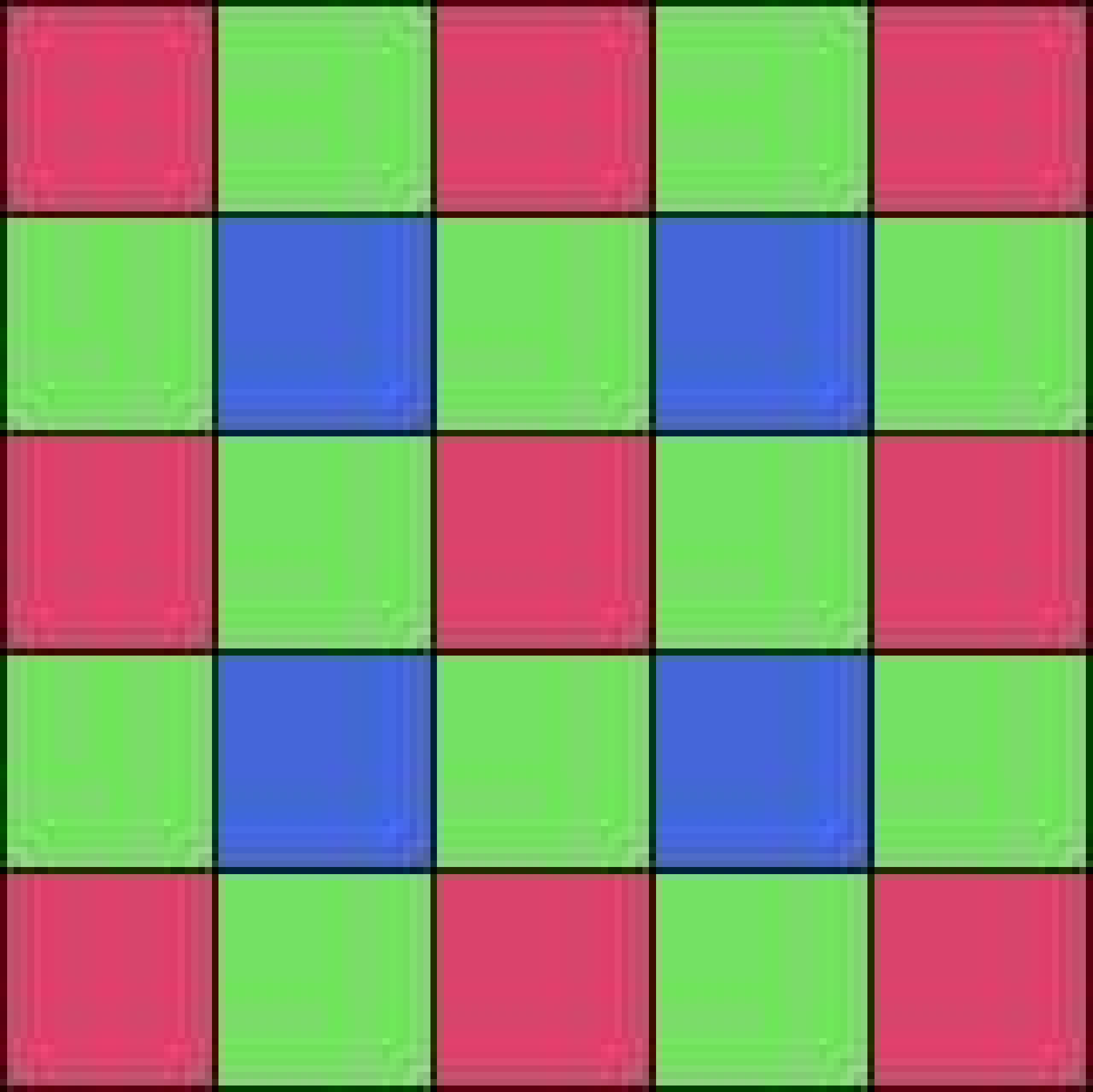

A horizontal rainbow gradient bar spanning the width of the image, with colors transitioning from red on the left to purple on the right.

Wikipedia

Wikipedia













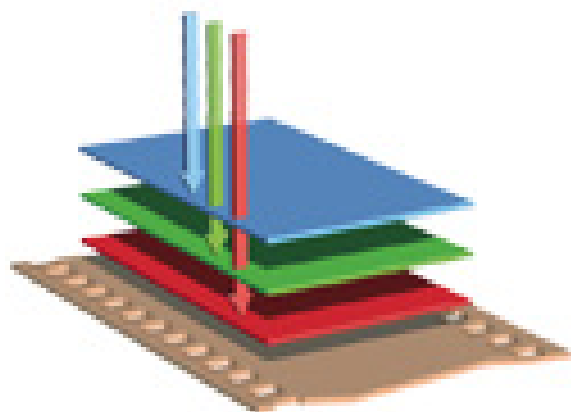

First came film.

COLOR FILM contains three layers of emulsion which directly record red, green, and blue light.

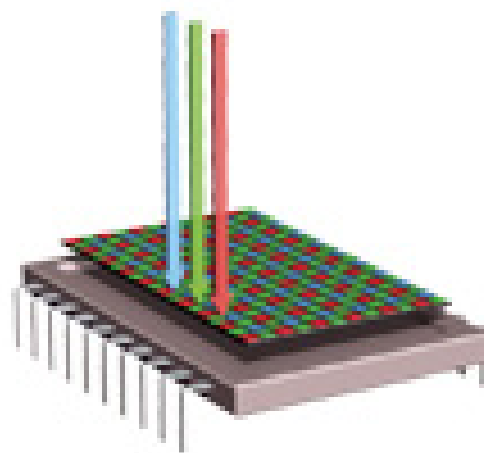

Then came digital.

TYPICAL DIGITAL SENSORS have just one layer of pixels and capture only part of the color.

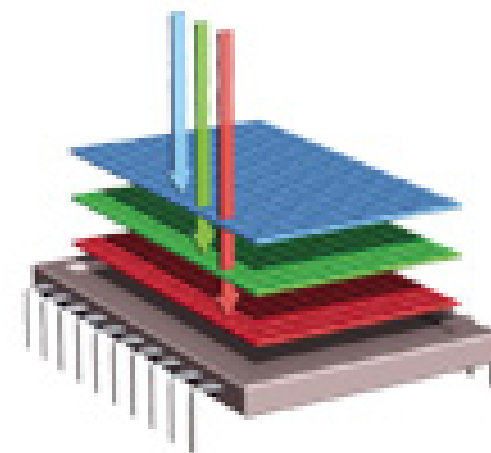

Now there's Foveon X3.

FOVEON X3 direct image sensors have three layers of pixels which directly capture all of the color.



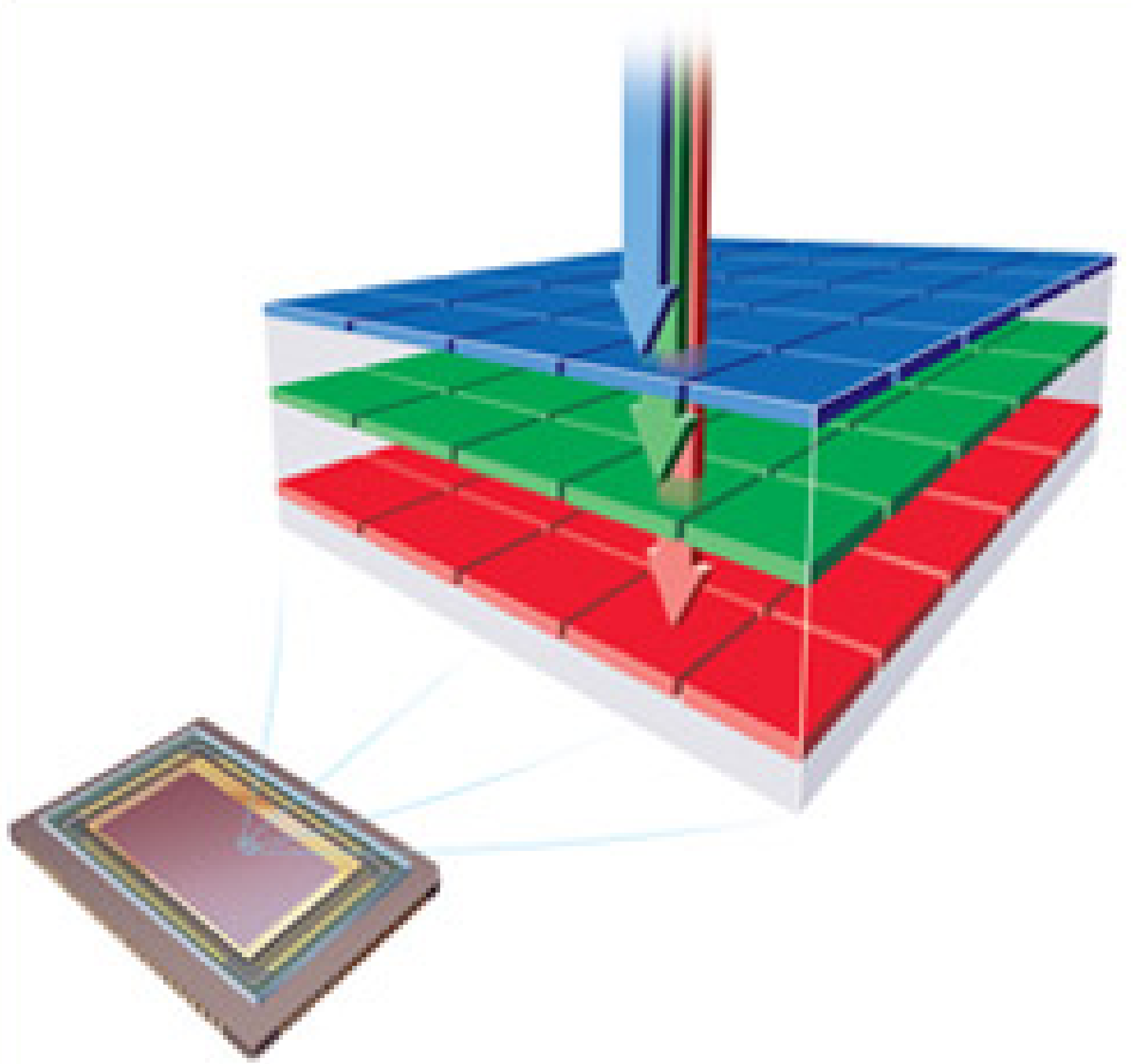

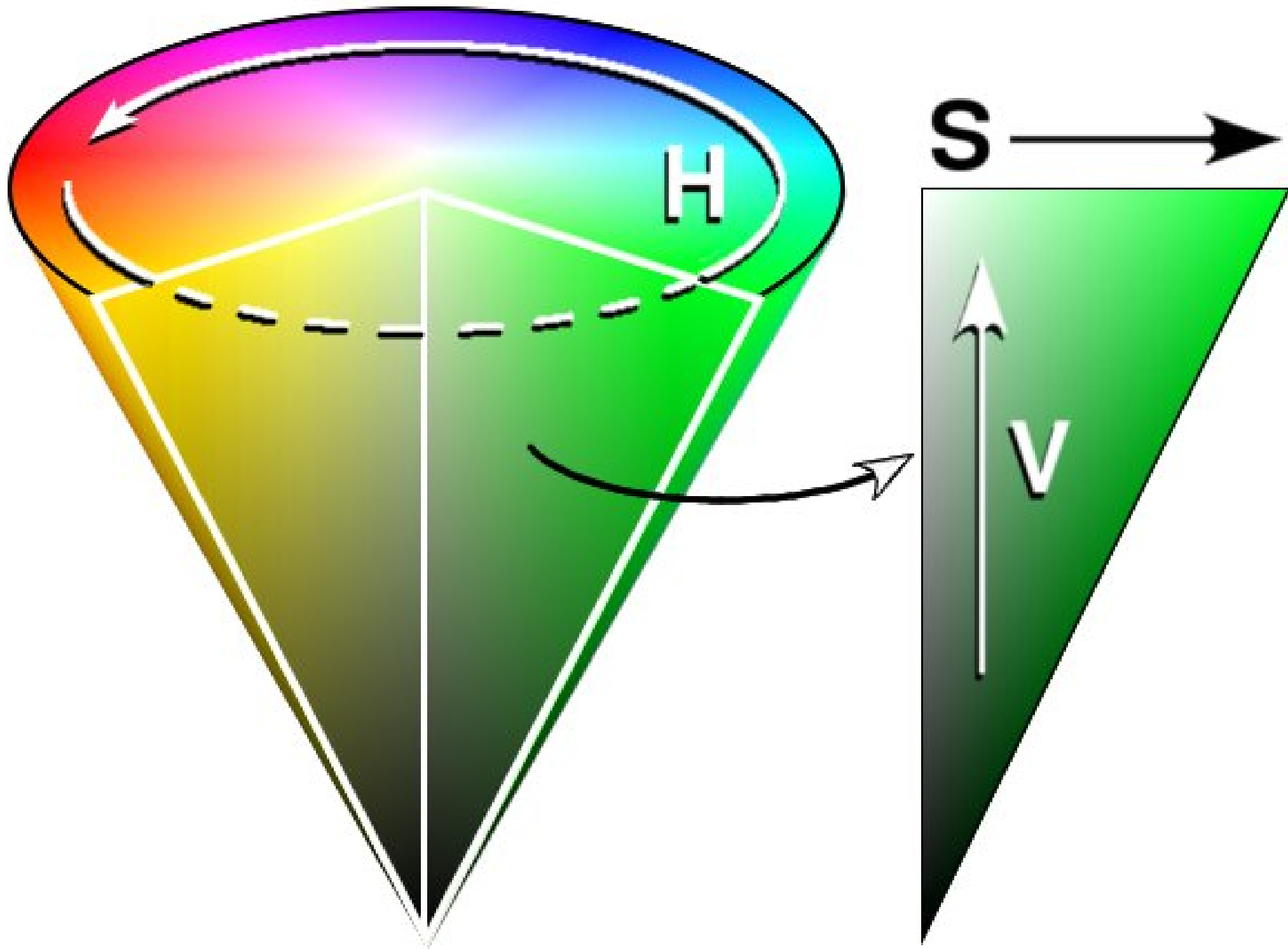









Color spectrum $S(\lambda)$

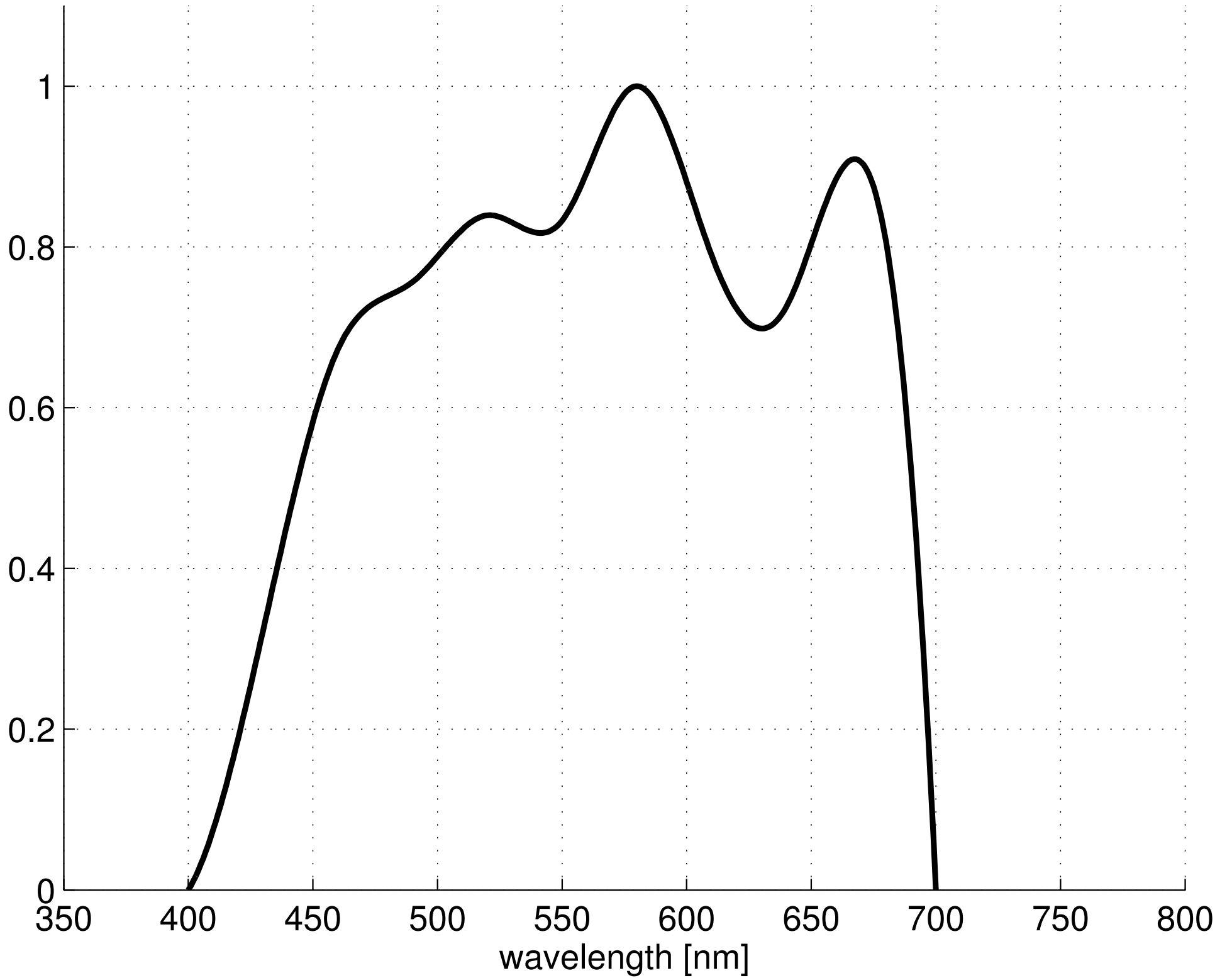

color matching functions for the RGB primaries

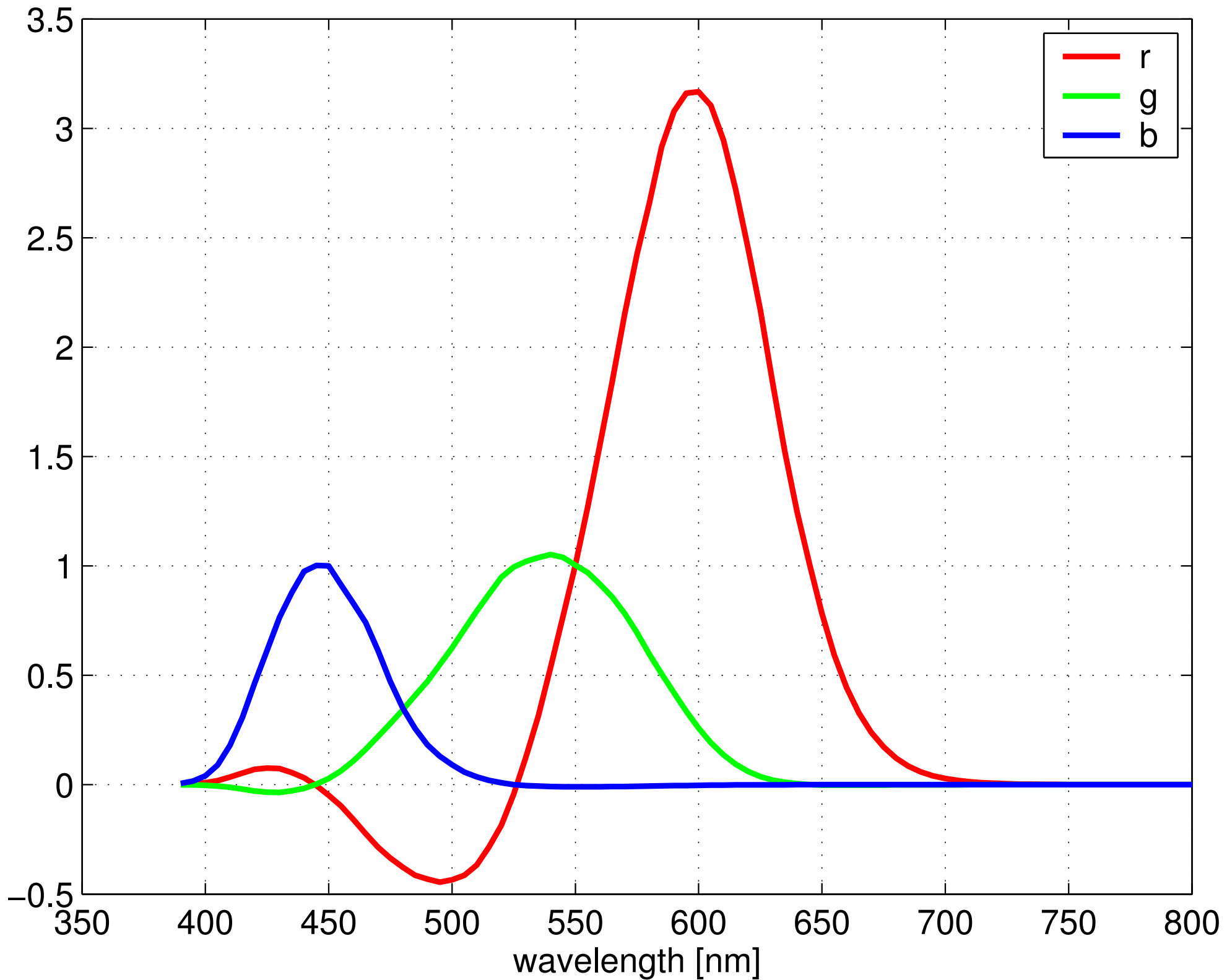

color matching functions for the CIE XYZ primaries

