

Image formation and its physical basis

Václav Hlaváč

Czech Technical University in Prague

Faculty of Electrical Engineering, Department of Cybernetics

Center for Machine Perception

<http://cmp.felk.cvut.cz/~hlavac>, hlavac@fel.cvut.cz

Outline of the lecture:

- ◆ Electromag. radiation. Its interaction with object surfaces.
- ◆ Radiometry, photometry, concepts.
- ◆ Irradiation equation.
- ◆ Surface reflectance. BDRF.
- ◆ Mathematical models of reflectance.
- ◆ Lambertian surfaces.

Three types of energy used in imaging

1. Electromagnetic radiation (will be developed in detail in the sequel).
2. Radiation of elementary particles, e.g., electrons or neutrons.
3. Acoustic waves in gases, liquids and rigid bodies.

In gases and liquids, only the longitudinal wave is propagated. In rigid bodies, also the transverse wave occurs. The speed of acoustic waves propagation is proportional to elastic properties of the medium through which it propagates.

-
- ◆ The radiation interacts with the matter either on its surface or in its volume.
 - ◆ The radiation interacts with the matter either on its surface or in its volume. The radiation is emitted either due to the own heat motion of molecules (hot radiating body) or due to external stimulation (reflected radiation, luminescence, etc.).

Body and surface reflection

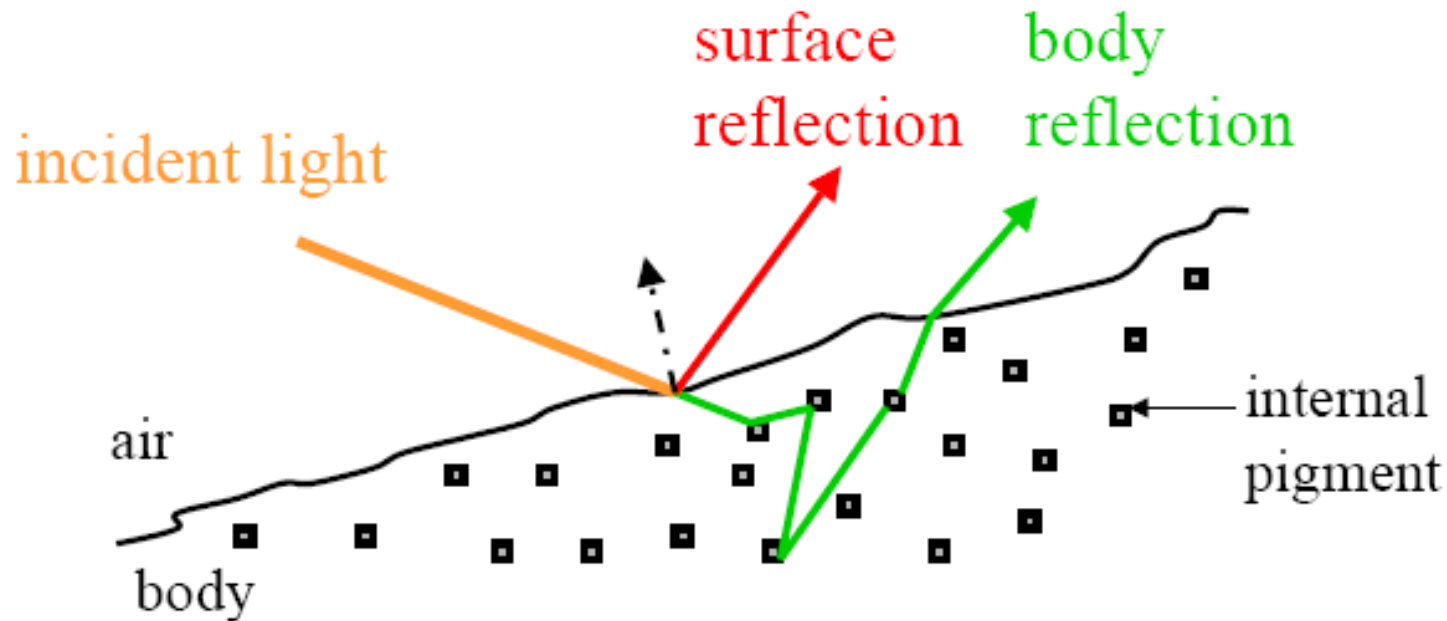

- ◆ **Surface reflection** – – glossy, highlights are very directional. Called also specular reflection.
- ◆ **Body reflection** – diffusion, reflection to all direction, internal pigment filters part of illuminant color spectra and causes color perception by humans.
- ◆ Metals manifest only the surface reflection..
- ◆ Dielectric materials (plastic, paint) manifest both surface and body reflection.

Electromagnetic radiation (1)

Includes γ rays, X rays, ultraviolet (UV) radiation, visible light, infrared radiation, microwaves and radiowaves.

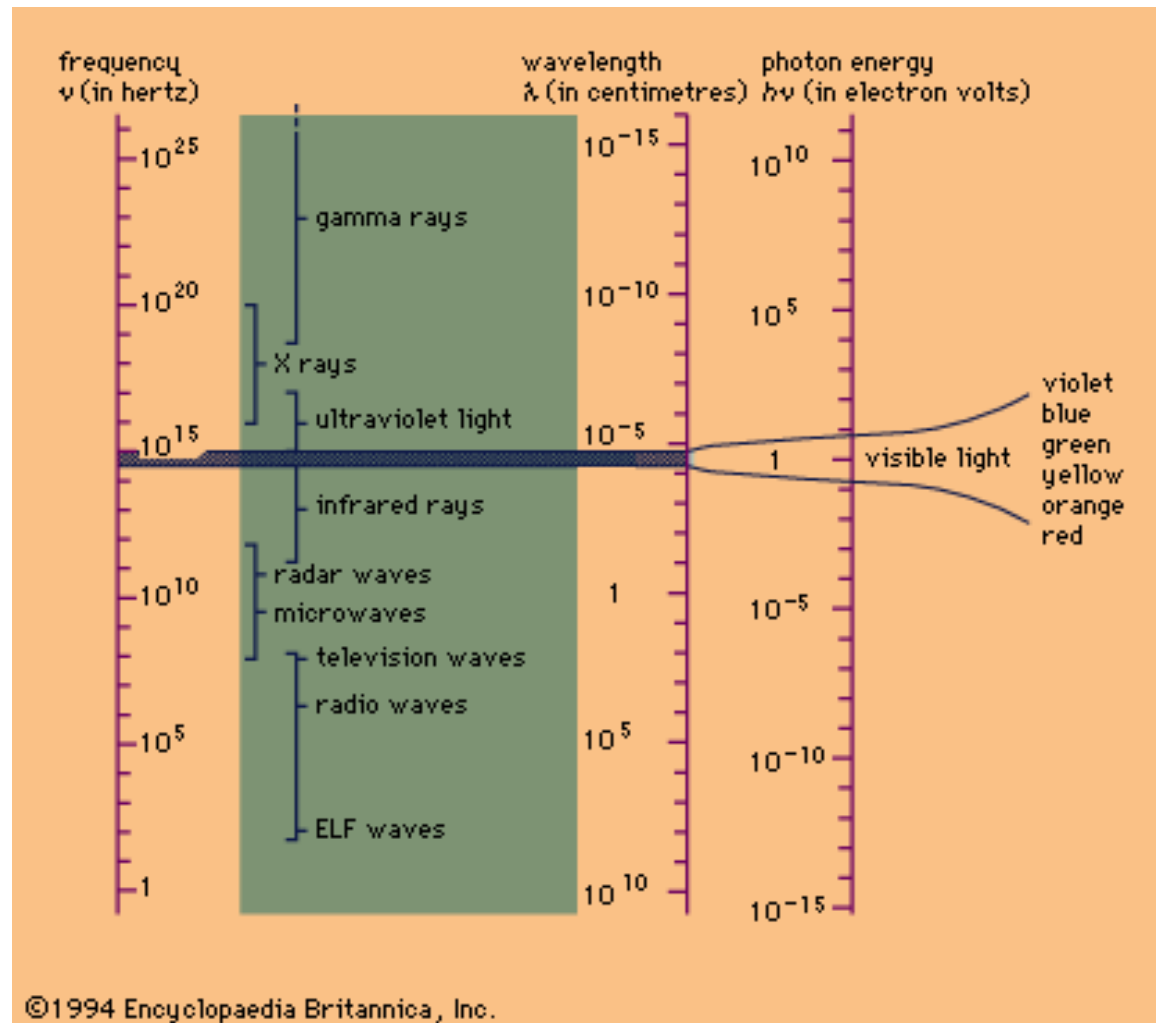

Electromagnetic radiation (2)

- ◆ The radiation spreads in vacuum in the speed of light. If radiation penetrates the matter then its speed reduces and in addition it depends on the wavelength of the light.
- ◆ We will constrain our thoughts to the visible part of the electromagnetic radiation spectrum here.

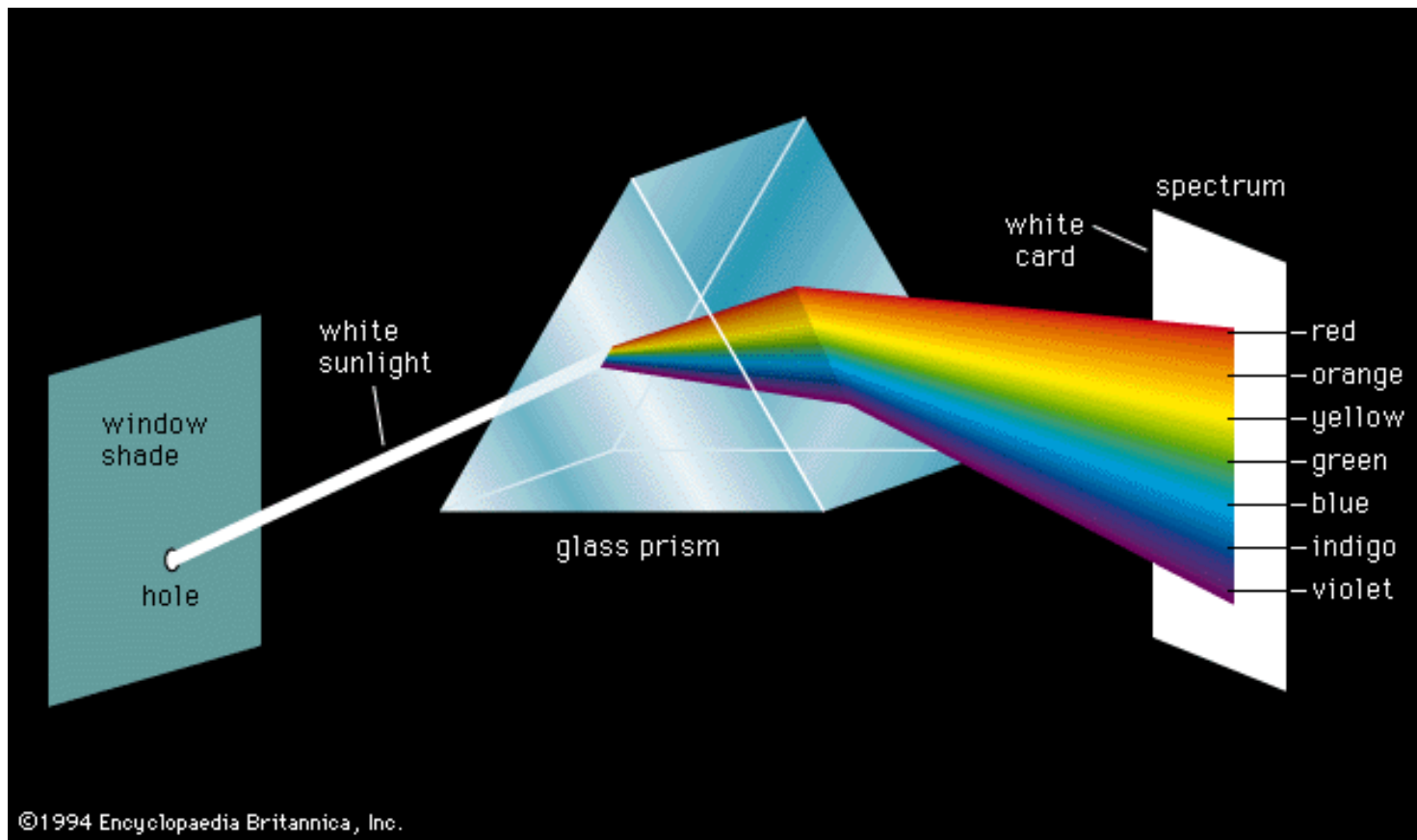

Data in light useful in image analysis

1. **Frequency** of the radiation or alternatively its wavelength.
2. **Amplitude**, i.e. the light intensity.
3. **Polarization mode** for a transverse wave.
4. **Phase** of a wave which is accessible only if coherent imaging technology is used as in interferometry or holography.

To simplify the story, we will study formation of the image due to the radiation reflection from opaque surfaces (from a radiometric point of view).

Radiometry and photometry

Radiometry is a branch of physics studying the flow and the transmission of excited energy.

- ◆ Radiometry allows to explain image formation mechanism.
- ◆ Informally, the brightness in a pixel depends on a shape of the object, the reflectance properties of its surface, position of the viewer, positions and types of illumination sources.

Photometry, uses analogical quantities as radiometry but takes into account human perception system properties.

- ◆ Photometric quantities depend also on a spectral characteristics of the illumination source and the sensitivity of the photosensitive cells on the human eye retina.

Concepts and quantities (1)

- ◆ Radiant flux Φ [W].
- ◆ Luminous flux Φ_{ph} [lm (=lumen)];
 1 [W] = 680 [lm] for the wavelength $\lambda = 555$ [nm] and the daylight vision in which retina cones are involved.
- ◆ Let $K(\lambda)$ luminous efficacy [lm W⁻¹], $S(\lambda)$ [W] the spectral power of the light source, and λ [m] is the wavelength.

Then, the luminous flux Φ_{ph} is proportional to the intensity of perception and is given by

$$\Phi_{ph} = \int_{\lambda} K(\lambda) S(\lambda) d\lambda .$$

Plane and spatial angles

Supplementary SI units [rad], [sr]

Plane angle – radian [rad].

Radian is the plane angle between two radii of a circle which cut off on the circumference an arch equal in length to the radius.

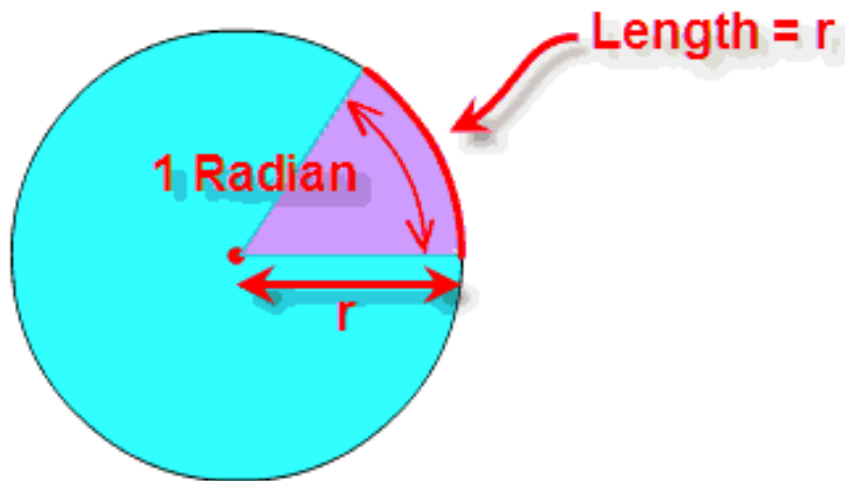

Solid angle – steradian [sr].

Steradian is the solid angle which, having its vertex in the center of the sphere, cuts off an area of the surface of the sphere equal to that of a square with sides of lengths equal to the radius of the sphere.

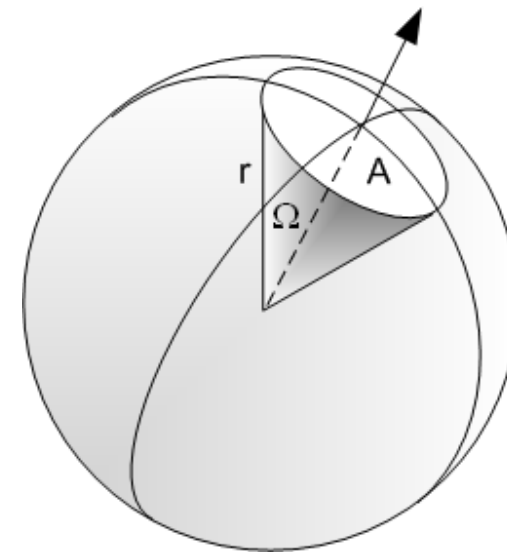

Spatial angle (1)

- ◆ The body surface can emit energy into the whole semi-sphere and, possibly, in different way in different directions.
- ◆ The **spatial angle** Ω is given by the area on the surface of the unit sphere that is bounded by a cone with an apex in the center of the sphere.
- ◆ The whole half-sphere corresponds to the spatial angle of 2π [sr, (=steradian)].

Relative foreshortening of the slanted surface patch area

A small surface patch A at the distance R from the origin, i.e. $R^2 \gg A$, with the angle Θ between the normal vector to the patch and the radius vector between the origin and the patch corresponds to

$$\Omega = \frac{A \cos \Theta}{R^2} .$$

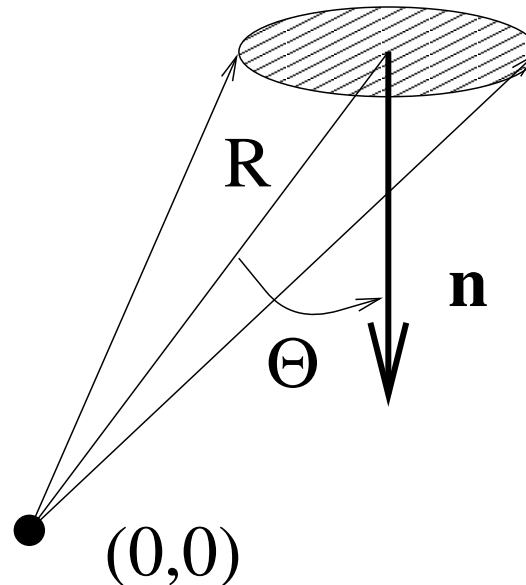

Concepts and quantities (2)

- ◆ Irradiance E [W m^{-2}] describes the power of the light energy that falls onto a unit area of the object surface, $E = \delta\Phi/\delta A$, where δA is an infinitesimal area element (patch) of the surface.
- ◆ The corresponding photometric quantity is illumination [lm m^{-2}].
- ◆ The much used photometric quantity in the image analysis is the brightness L_{ph} [$\text{lm m}^{-2} \text{sr}^{-1}$] because it well represents the quantity measured by the camera.
- ◆ The radiometric equivalent of the brightness is radiance L [$\text{W m}^{-2} \text{sr}^{-1}$], which is the power of light that is emitted from a unit surface area into the unit spatial angle [sr].

Irradiance equation (1)

We shall consider the relationship between the irradiance E measured in the image and the radiance L produced by a small patch on the object surface. Only part of this radiance is captured by the lens of the camera.

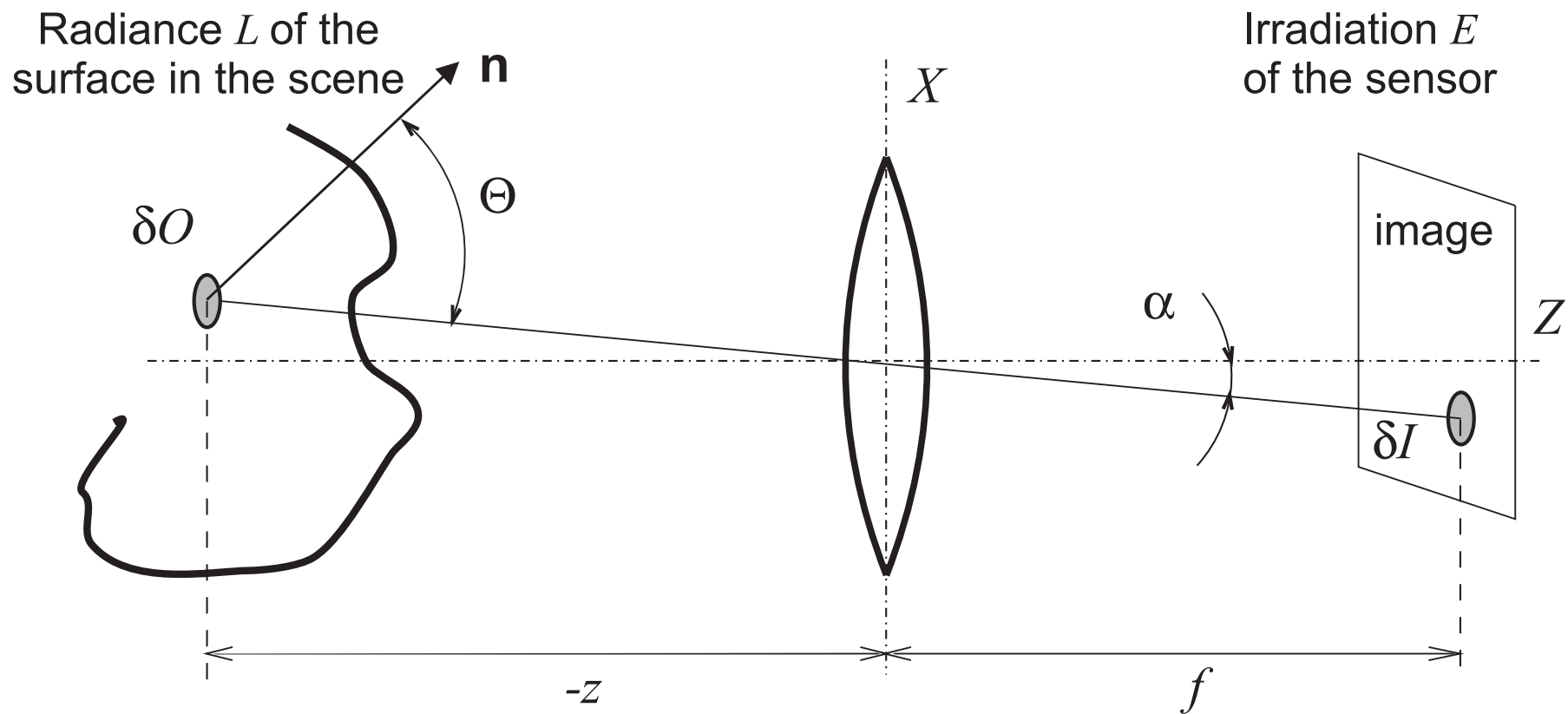

Irradiance equation (2)

- ◆ Let consider a pinhole camera model.
- ◆ A ray passing the center of the lens does not diffract. Thus the spatial angle matching to the elementary patch in the scene equals to the spatial angle matching to the elementary area in the image.
- ◆ The slanted area as seen from the center of the coordinate system is $\delta I \cos \alpha$ and its distance from the center of the optical system is $f / \cos \alpha$.
- ◆ The corresponding spatial angle is

$$\frac{\delta I \cos \alpha}{\left(\frac{f}{\cos \alpha}\right)^2}.$$

Irradiance equation (3)

Analogously, the spatial angle corresponding to the elementary patch δO on the object surface is

$$\frac{\delta O \cos \Theta}{\left(\frac{z}{\cos \alpha}\right)^2}.$$

As the spatial angles on the surface and image sides are equal

$$\frac{\delta O}{\delta I} = \frac{\cos \alpha z^2}{\cos \Theta f^2}.$$

Irradiance equation (4)

Consider how much light energy passes through the lens if its aperture has the diameter d .

The spatial angle Ω_L that sees the lens from the elementary patch on the object is

$$\Omega_L = \frac{\pi}{4} \frac{d^2 \cos \alpha}{\left(\frac{z}{\cos \alpha}\right)^2} = \frac{\pi}{4} \left(\frac{d}{z}\right)^2 \cos^3 \alpha .$$

Let L be the radiance of the object surface patch that is oriented towards the lens. Then the elementary contribution to the radiant flux Φ [W] falling at the lens is

$$\delta\Phi = L \delta O \Omega_L \cos \Theta = \pi L \delta O \left(\frac{d}{z}\right)^2 \frac{\cos^3 \alpha \cos \Theta}{4} .$$

Irradiance equation (5)

The lens concentrates the light energy into the image. If energy losses in the lens are neglected and no other light falls on the image element, we can express the irradiation E of the elementary image patch as

$$E = \frac{\delta\Phi}{\delta I} = L \frac{\delta O}{\delta I} \frac{\pi}{4} \left(\frac{d}{z}\right)^2 \cos^3 \alpha \cos \Theta .$$

If we substitute for $\frac{\delta O}{\delta I}$, we obtain an important equation that explains how scene radiance L influences irradiance E in the image

$$E = L \frac{\pi}{4} \left(\frac{d}{f}\right)^2 \cos^4 \alpha .$$

f -number of a lens

- ◆ In the irradiance equation,

$$E = L \frac{\pi}{4} \left(\frac{d}{f} \right)^2 \cos^4 \alpha .$$

the term $\frac{d}{f}$ appeared.

- ◆ Its inverted value $n_f = \frac{f}{d}$ is called f -number of the lens. It is an important parameter characterizing the lens. It tells how much the lens differs from a pinhole camera.

Natural vignetting

- ◆ The term $\cos^4 \alpha$ characterizes a systematic error (abberation) called the **natural vignetting** (the optical and mechanical vignetting exist too).
- ◆ Natural vignetting describes the phenomenon that rays with bigger angle α (i.e. more inclined from the optical axis) are attenuated more.
- ◆ This implies that this abberation is more pronounced with wide-angle lenses than with tele-lenses.
- ◆ As the natural vignetting is a systematic error, it can be compensated, of course, only for a camera with fixed focus and radiometrically calibrated setup.

Optical vignetting

- ◆ Real lenses are composed of several simple lenses and are several centimeters wide. Because of that not all diaphragm could be available for all rays..
- ◆ The phenomenon is naturally more pronounced for the open diaphragm.



Mechanical vignetting

It concerns only careless users.

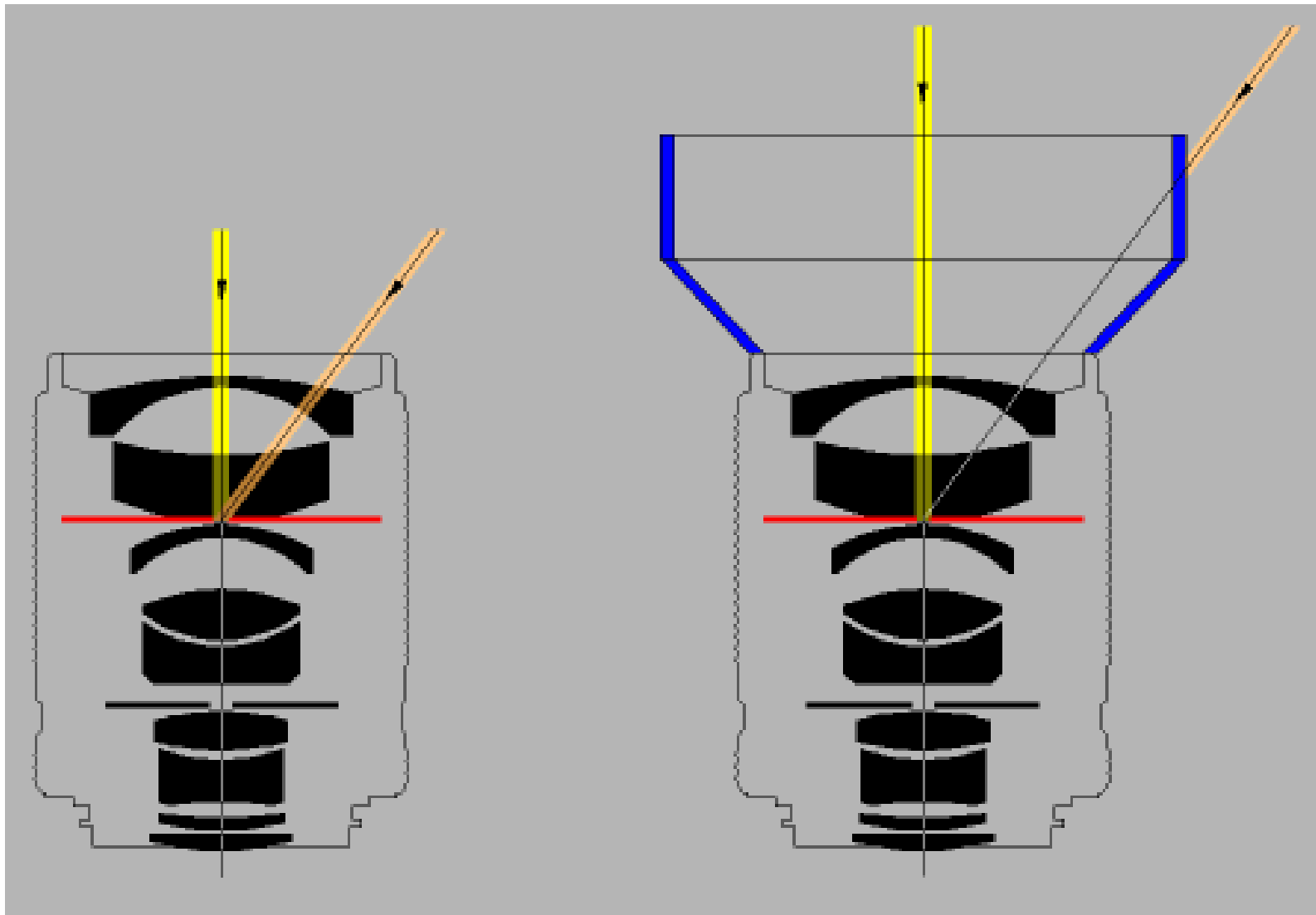

Surface reflectance

- ◆ In computer vision and graphics, the value of the image function $f(x, y)$ is understood as an estimate of the radiance L , which is caused by the reflected light energy caused by the irradiance E to the scene surface.
- ◆ The orientation of the elementary area is described in spherical coordinates, by azimuth φ and the polar angle Θ .

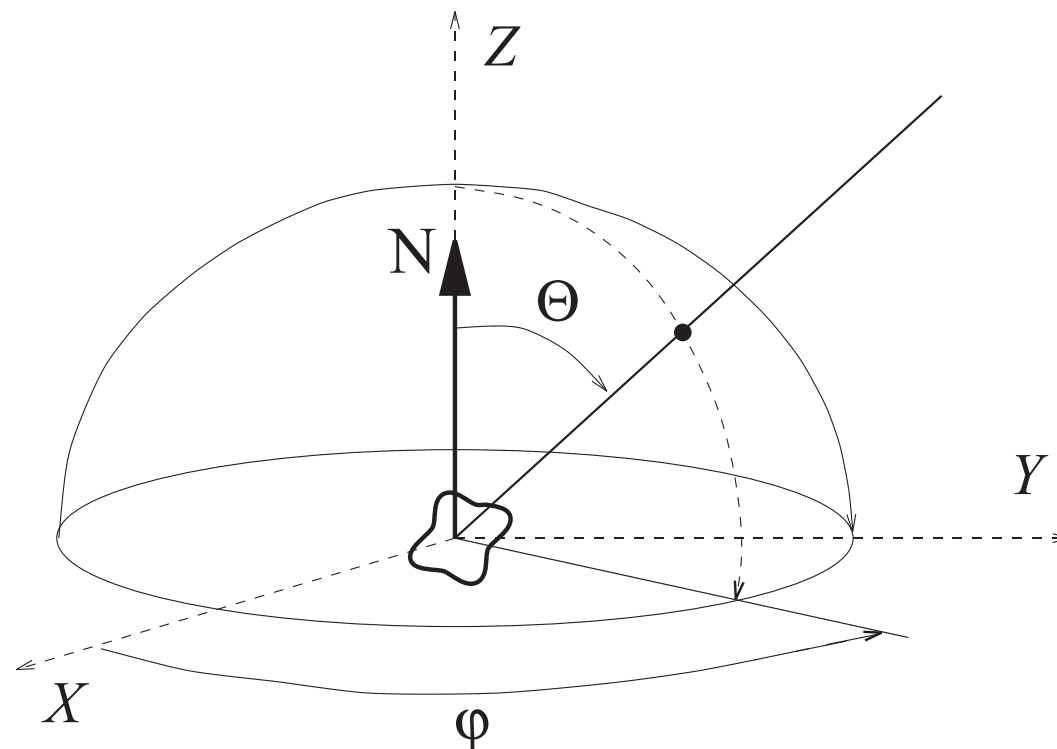

Light sources and the observer

- ◆ Radiance L (\sim brightness) of an opaque object not emitting own energy depends on the illumination of the object surface.
- ◆ The irradiance E depends on the type of light sources (e.g., if they are of a point or of a diffuse type) and on their position with regards to the surface patch and to the viewer.

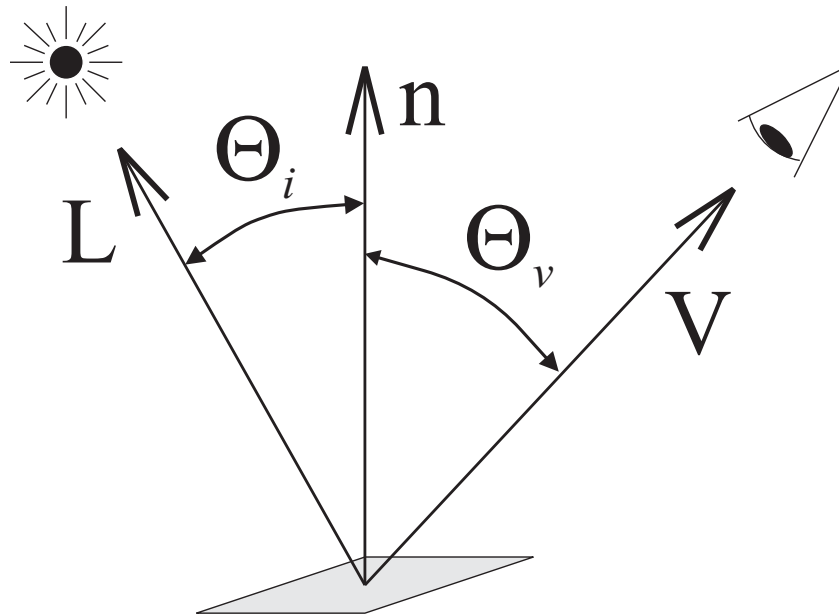

BRDF

- ◆ BRDF – Bidirectional Reflectance Distribution Function f_r .
- ◆ BRDF describes the brightness of an elementary surface patch for a specific material, a light source, and viewer directions as a ratio between a measured radiance reflected from a surface caused by irradiance E from a certain direction. The influence of the phase is neglected for simplicity.

$$f_r(\Theta_i, \varphi_i; \Theta_v, \varphi_v) = \frac{\delta L(\Theta_v, \varphi_v)}{\delta E(\Theta_i, \varphi_i)} \quad [\text{sr}^{-1}].$$

- ◆ BRDF is also important for realistic rendering in computer graphics. It is needed in its full complexity used for modeling reflection properties of materials with oriented microstructure (e.g., tiger's eye—a semi-precious golden-brown stone, a peacock's feather, a rough cut of aluminum).
- ◆ It is measured on a goniometr.

Example of the complex BRDF – the frozen snow



The frozen snow, detail



The frozen snow, dependence on the orientation



A simplified BRDF

- ◆ For very many practically important surfaces, BRDF does not depend on the rotation of the elementary surface patch along the normal to the surface. In such a case, f_r depends only on the difference of azimuths of the directions to the light source and the viewer, $\varphi_i - \varphi_v$, which means on $f_r(\Theta_i, \Theta_v, (\varphi_i - \varphi_v))$.
- ◆ The simplification holds for opaque (Lambertian) surfaces, ideally reflecting surfaces (mirrors) and their combinations.

Reflectance coefficient = albedo

- ◆ The albedo expresses what ratio of the incident energy the surface reflects back to the halfspace.
- ◆ Simplification: We will neglect the influence of a surface color and the dependence of the albedo on the light wavelength λ .
- ◆ $E_i(\lambda)$ is the radiance caused by the illuminated surface patch and $E_r(\lambda)$ is the flow of energy on the unit area radiated by the surface patch back to the halfspace.
- ◆ The sought ratio is the integral of the radiance L from the surface patch in a spatial angle Ω , which matches the whole halfspace.

$$E_r = \int_{\Omega} L \, d\Omega .$$

Reflectance function $R(\Omega)$

- ◆ $R(\Omega)$ models the influence of the local changes of the surface geometry to the dissipation of the reflected energy into the space.
- ◆ Let Ω be the infinitesimal space angle around the view direction,

$$\int_{\Omega} R \, d\Omega = 1.$$

- ◆ The reflective properties of the surface depend on three angles in general, which express mutual between the direction towards the illumination source \mathbf{L} , the direction towards the viewer \mathbf{V} , and the local orientation of the surface patch given by its normal vector \mathbf{n} .

Reflectance function (2)

- ◆ Cosines of vectors (directions) towards the illumination source \mathbf{L} , towards the viewer \mathbf{V} and local orientation of the surface given by the normal vector \mathbf{n} can be rewritten as the dot product, denoted as (\cdot) , of vectors.
- ◆ Then, the reflectance function $R(\mathbf{n} \cdot \mathbf{L}, \mathbf{n} \cdot \mathbf{V}, \mathbf{V} \cdot \mathbf{L})$.

A special case = Lambertian surface

- ◆ Lambertian surface (also ideally opaque surface, ideal diffusion surface) reflects the light energy uniformly into all directions.
- ◆ That is the reason why the radiance (and also the perceived brightness) is the same from all the directions,

$$f_{\text{Lambert}}(\Theta_i, \Theta_v, \varphi_i - \varphi_v) = \frac{\rho(\lambda)}{\pi}.$$

- ◆ The name comes from the book Photometria by Johann Heinrich Lambert issued in Latin in 1760. The word “albedo” was used there for the first time.

Lambertian surface (2)

- ◆ The reflectance of the Lambertian surface can be expressed as a cosine law for the constant albedo $\rho(\lambda)$

$$R = \frac{1}{\pi} \mathbf{n} \cdot \mathbf{L} = \frac{1}{\pi} \cos \Theta_i .$$

- ◆ Notice that the reflectance function ρ does not depend on the viewing direction \mathbf{V} .
- ◆ Lambertian reflectance model is very popular because of its simplicity.

Numerical reflectance values pro for Lambertian surfaces

- ◆ Lambertian surface illuminated by parallel light rays with the polar angle Θ and illumination E .
- ◆ The radiance L is observed.
- ◆ Examples of materials their reflectance can be approximated as Lambertian for values $\rho(\lambda)$, where λ lies in approximately in the middle of the visible spectrum.
- ◆ White blotting paper = 0.8. White paper = 0.68. White ceiling or yellowish paper = 0.6. Dark brown paper = 0.14. Dark velvet = 0.004.

Ideal mirror surface

- ◆ It reflects the irradiance from the direction (Θ_i, φ_i) into the direction $(\Theta_i, \varphi_i + \pi)$.
- ◆ The actual surface is not visible. The virtual image is shown which is mirror reflected image of the illumination sources, i.e. surfaces in the scene emitting light.