

B and B+ search tree

Marko Berezovský
Radek Mařík
PAL 2012

To read

- Robert Sedgwick: *Algorithms in C++, Parts 1–4: Fundamentals, Data Structure, Sorting, Searching, Third Edition*, Addison Wesley Professional, 1998
- <http://www.cs.helsinki.fi/u/mluukkai/tirak2010/B-tree.pdf>
- (CLRS) Cormen, Leiserson, Rivest, Stein: *Introduction to Algorithms*, 3rd ed., MIT Press, 2009

See PAL webpage for references

B-tree -- Rudolf Bayer, Edward M. McCreight, 1972

- All lengths of paths from the root to the leaves are equal.
- B-tree is perfectly balanced. Keys in the nodes are kept sorted.
- Fixed parameter $k > 1$ dictates the same size of all nodes.
- Each node except for the root contains at least k and at most $2k$ keys and if it is not a leaf it has at least $k+1$ and at most $2k+1$ children.
- The root may contain any number of keys from 1 to $2k$. If it is not simultaneously a leaf it has at least 2 and at most $2k+1$ children.

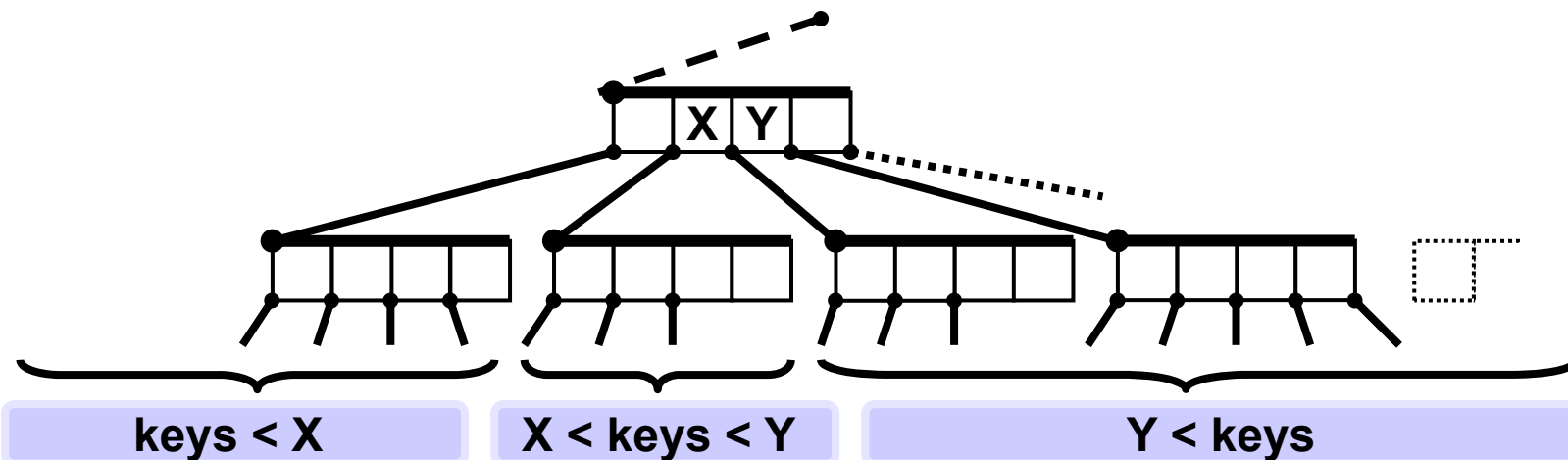

Cormen et al. 1990: B-tree degree:

Nodes have lower and upper bounds on the number of keys they can contain. We express these bounds in terms of a fixed integer $t \geq 2$ called the minimum degree of the B-tree:

- a. Every node other than the root must have at least $t-1$ keys.
Every internal node other than the root thus has at least t children.
If the tree is nonempty, the root must have at least one key.
- b. Every node may contain at most $2t-1$ keys.
Therefore, an internal node may have at most $2t$ children.

t = 2

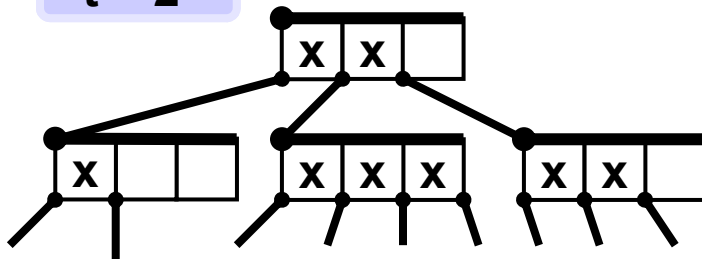

min keys = 1 max keys = 3
children = 2 children = 4

t = 5

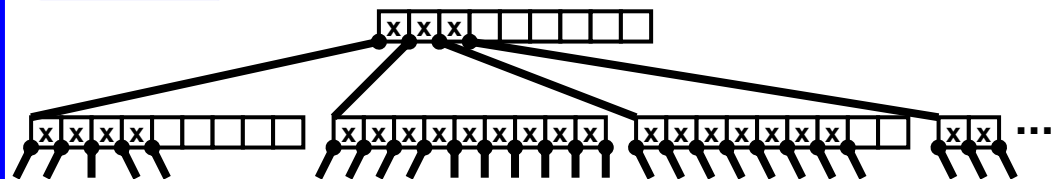

min keys = 4 max keys = 9
children = 5 children = 10

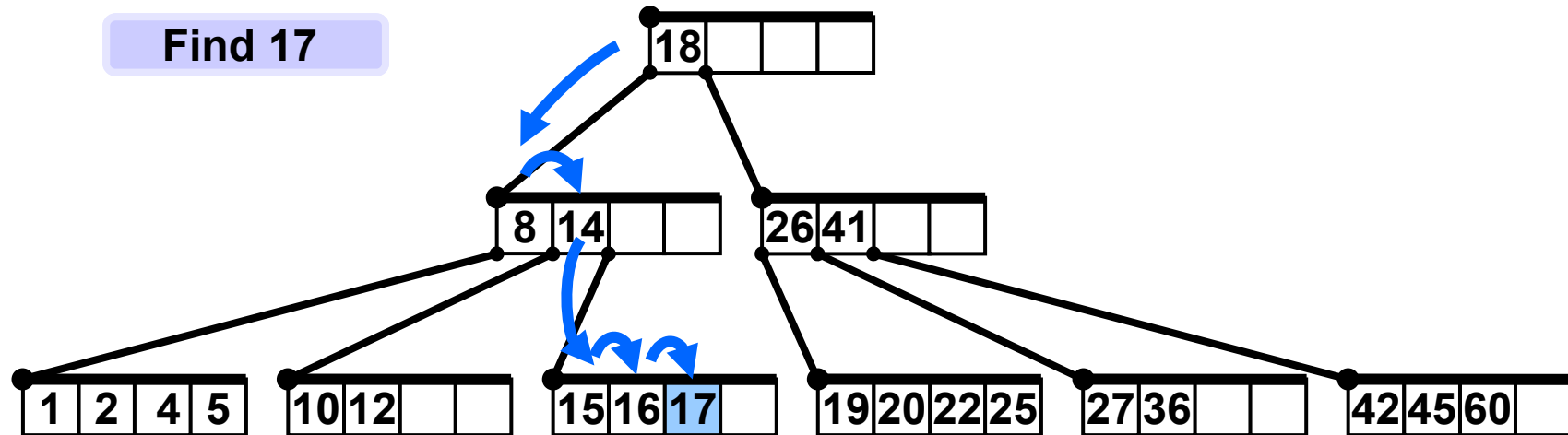

Search in the node is sequential (or binary or other...).

If the node is not a leaf and the key is not in the node then the search continues in the appropriate child node.

If the node is a leaf and the key is not in the node then the key is not in the tree.

Update strategies:

1. **Multi phase strategy:** “Solve the problem when it appears”.
First insert or delete the item and only then restructure the tree if necessary.
This may require additional traversing back to the root.
2. **Single phase strategy:** “Avoid the future problems”.
Travel from the root to the node/key which is to be inserted or deleted
and during the travel restructure the tree to prevent the additional
traversing back to the root.

Multi phase strategy

B-tree

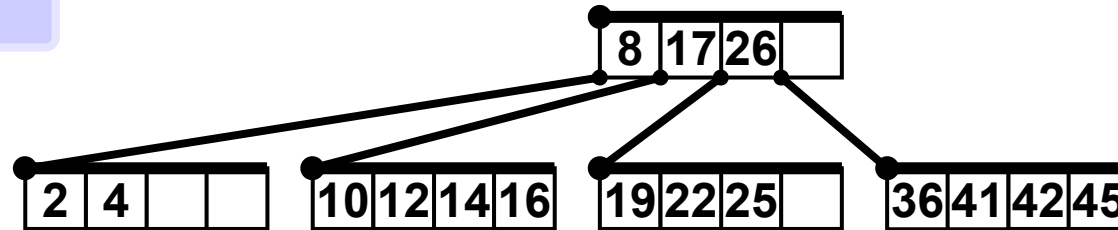

Insert 5

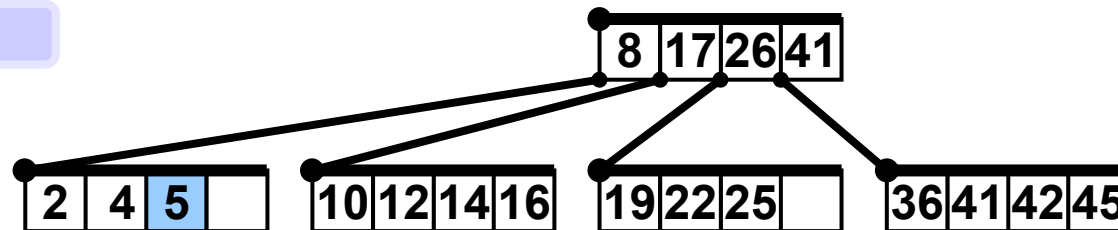

Insert 20

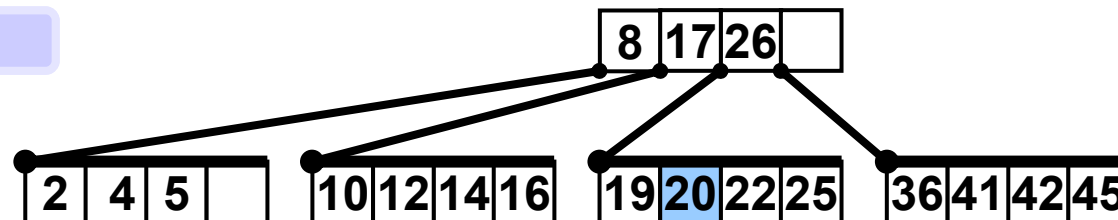

Multi phase strategy

Insert 27

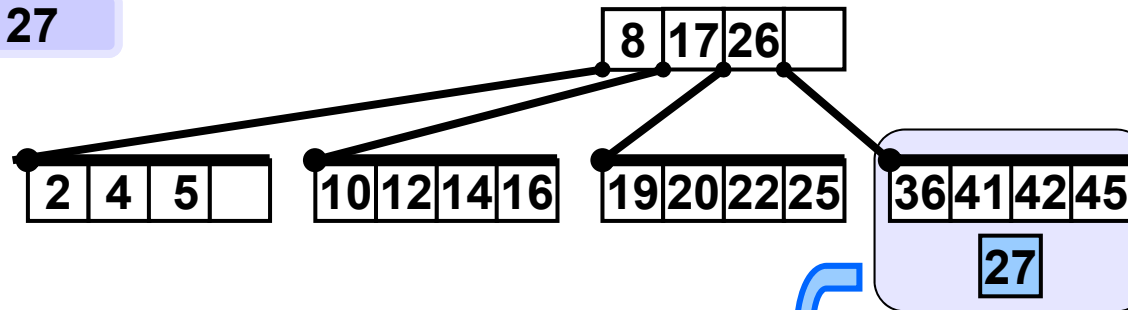

Sort outside the tree.

Select median, create new node, move to it the values bigger than the median.

Try to insert the median into the parent node.

Success.

27 36 41 42 45

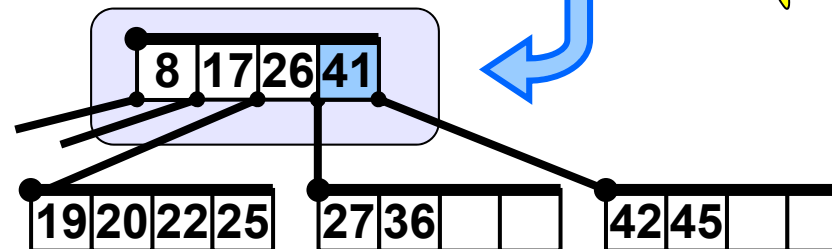
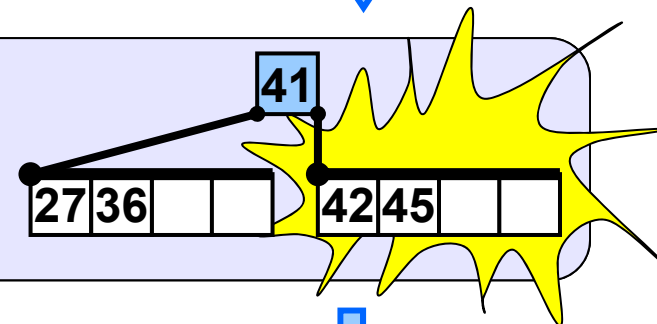

Multi phase strategy

Insert 15

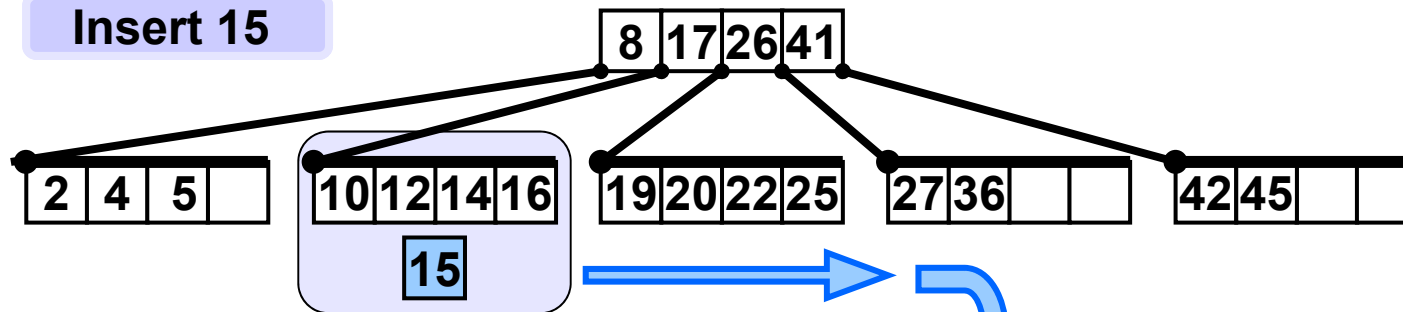

Sort outside the tree.

Select median, create new node, move to it the values bigger than the median.

Try to insert the median into the parent node.

Success?

[10 | 12 | 14 | 15 | 16]

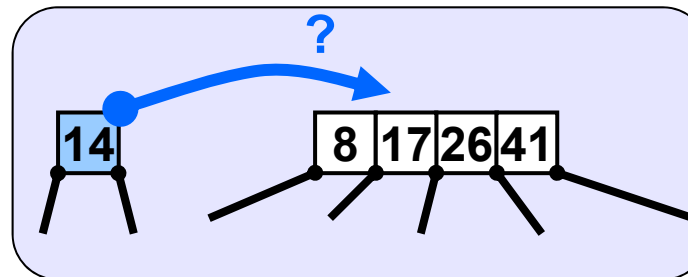
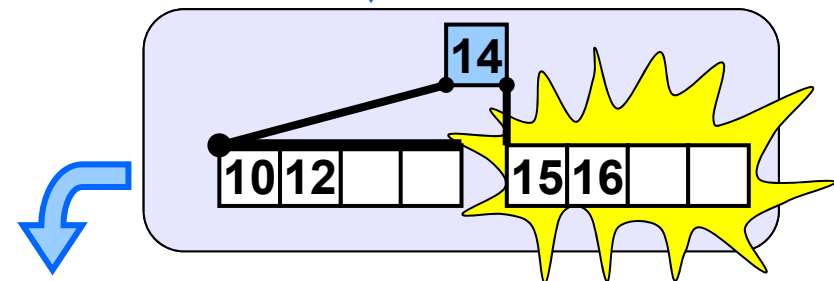

B tree - Insert

Insert rules III

8

Multi phase strategy

Key 15 inserted into a leaf...

... key 14 goes to parent node

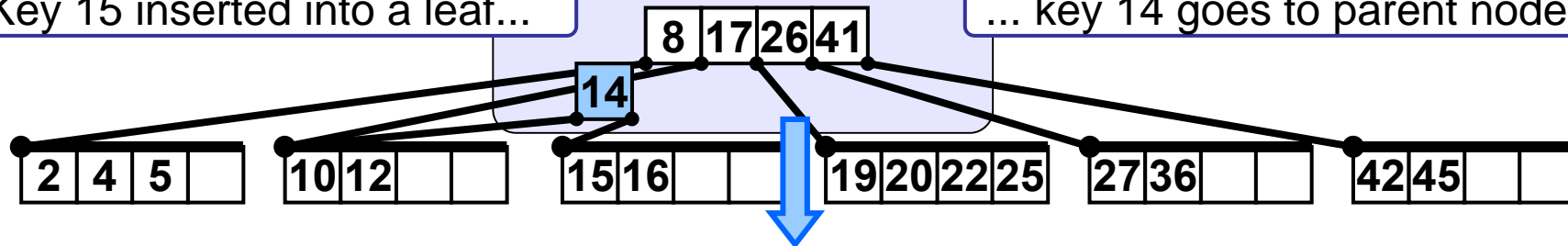

The parent node is full – repeat the process analogously.

Sort values

Select median, create new node, move to it the values bigger than the median together with the corresponding references.

Cannot propagate the median into the parent (there is no parent), create a new root and store the median there.

8 14 17 26 41

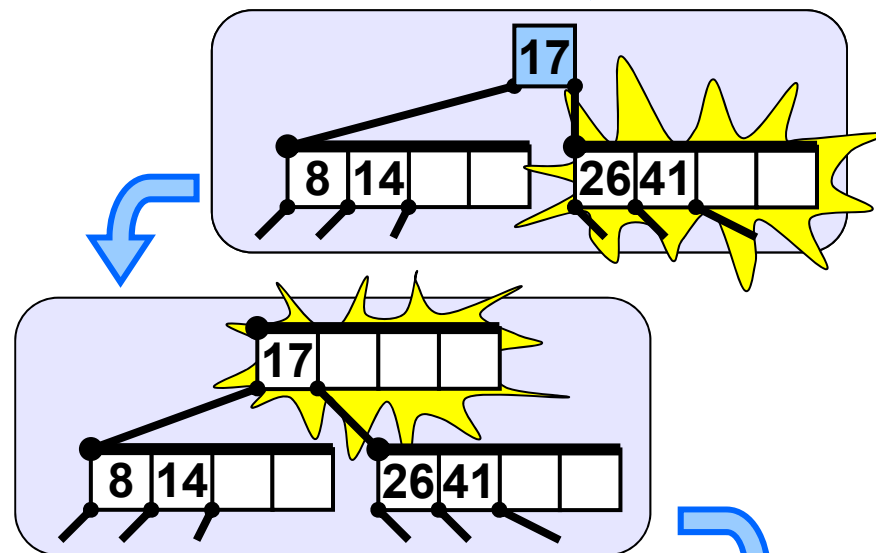

Multi phase strategy

Recapitulation - insert 15

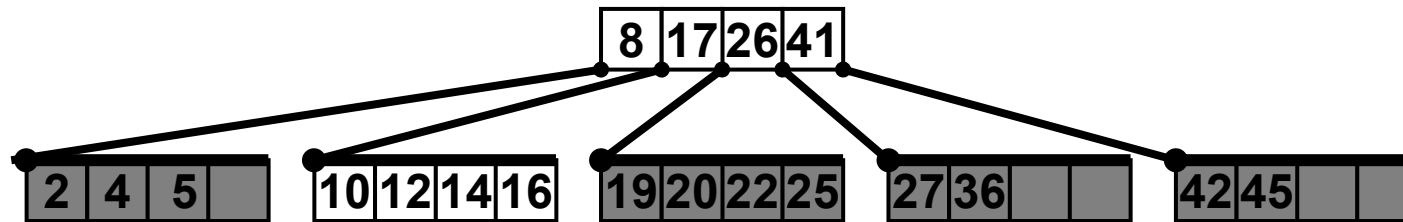

Insert 15

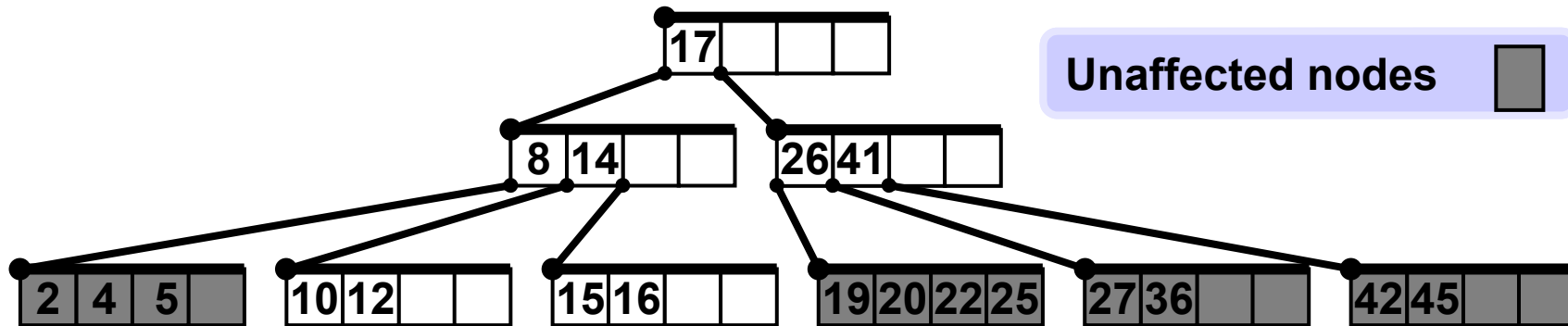

Unaffected nodes

Each level acquired one new node, a new root was created too, the tree grows upwards and remains perfectly balanced.

B tree - Delete

Multi phase strategy

Delete in a sufficiently full leaf.

Delete 4

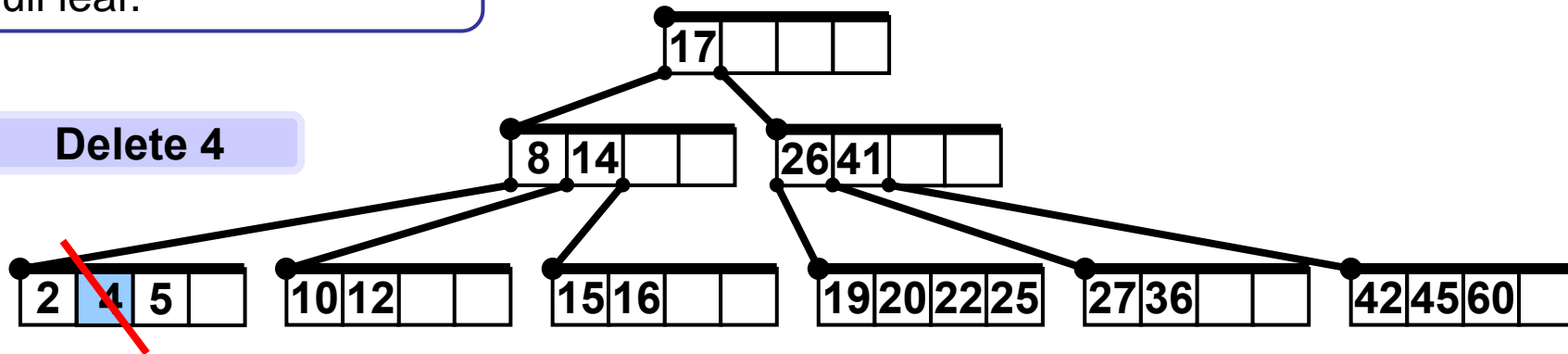

Deleted

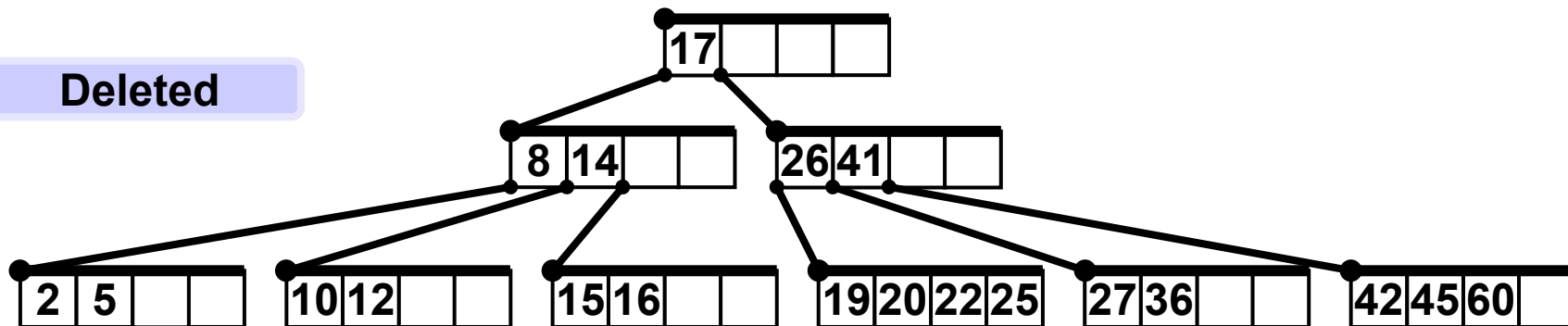

Multi phase strategy

Delete in an internal node

Delete 17

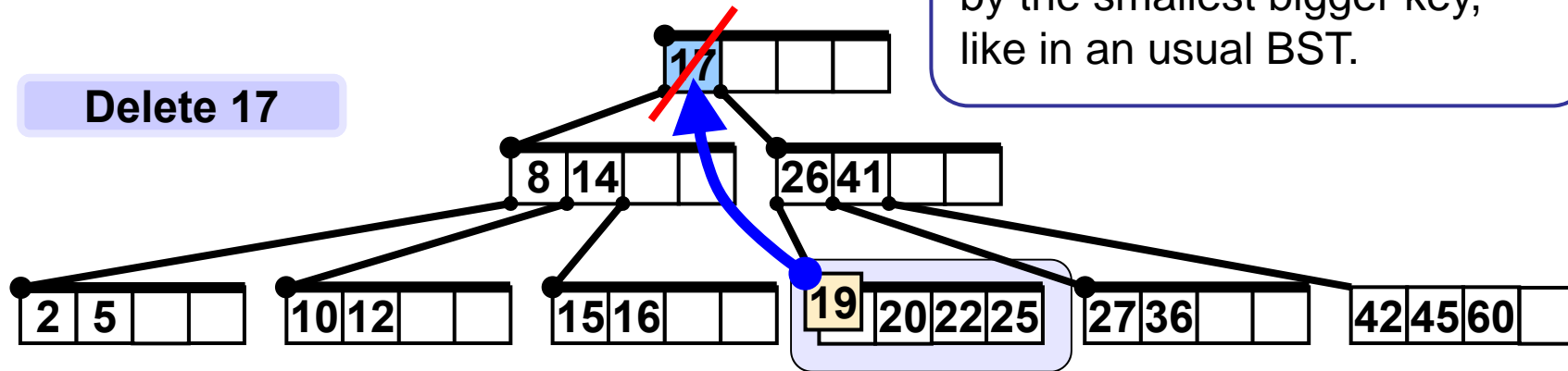

The deleted key is substituted by the smallest bigger key, like in an usual BST.

The smallest bigger key is always in the leaf in a B-tree. If the leaf is sufficiently full the delete operation is complete.

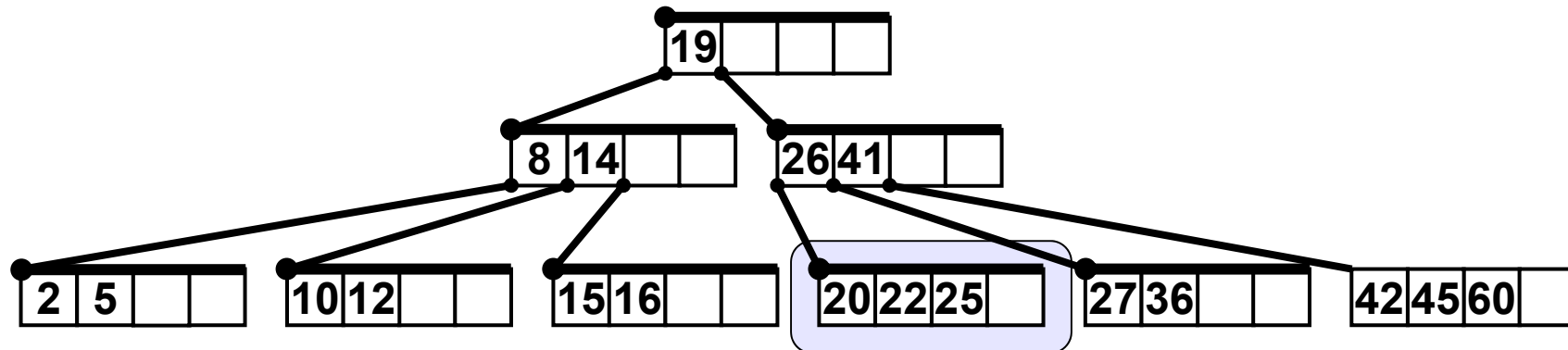

B tree - Delete

Multi phase strategy

Delete in an insufficiently full leaf.

The neighbour leaf is sufficiently full.

Delete 27

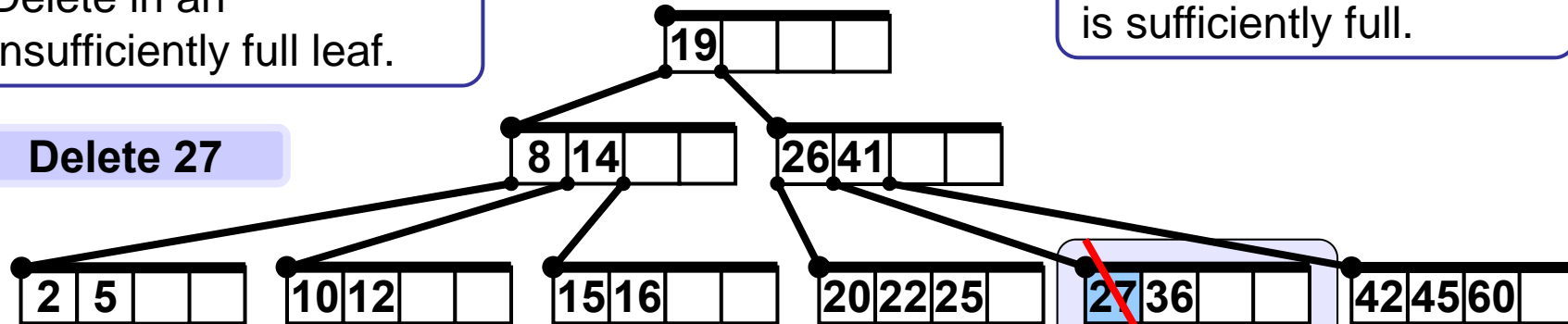

Merge the keys of the two leaves with the dividing key in the parent into one sorted list.

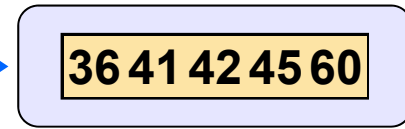
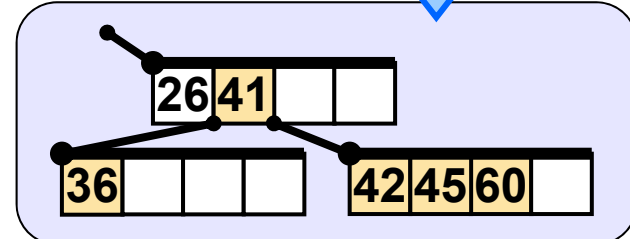

Insert the median of the sorted list into the parent and distribute the remaining keys into the left and right children of the median.

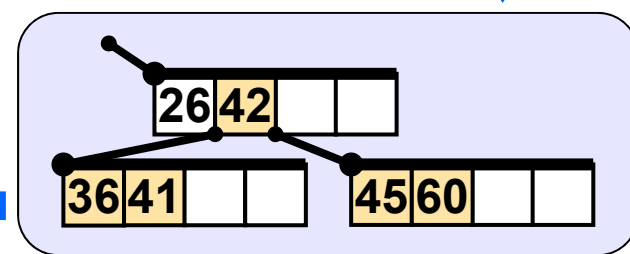

Multi phase strategy

Recapitulation - delete 27

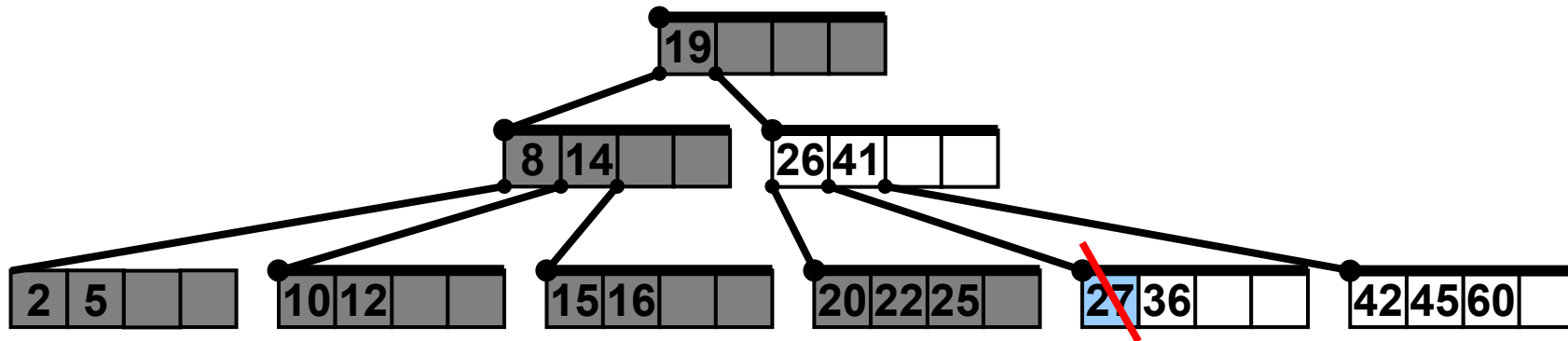

27 correctly deleted

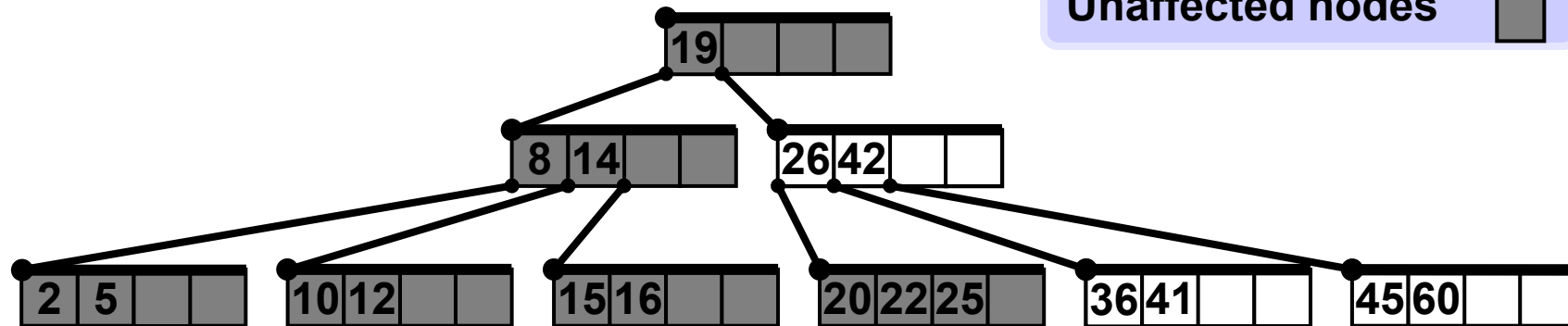

B tree - Delete

Multi phase strategy

Delete in an insufficiently full node.

None of the neighbours is sufficiently full.

Delete 12

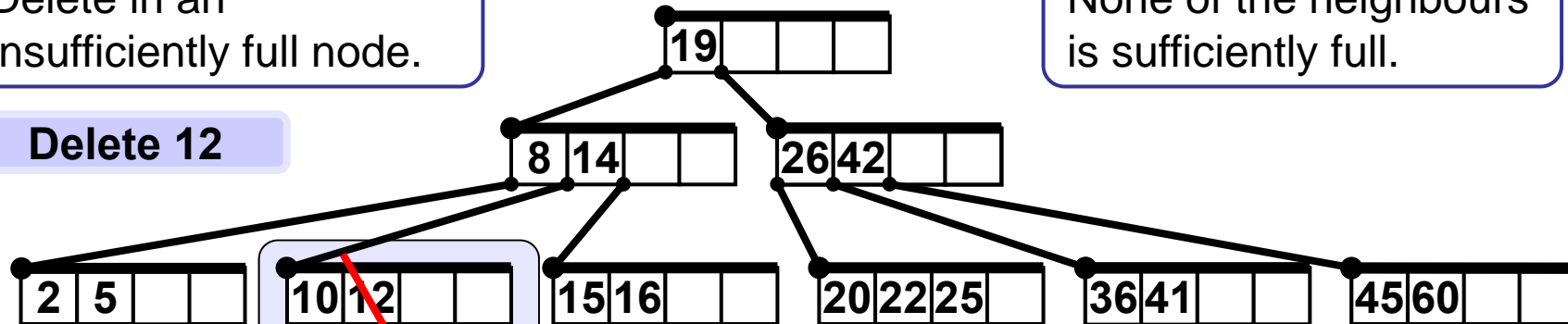

Merge the keys of the node and of one of the neighbours and the median in the parent into one sorted list. Move all these keys to the original node, delete the neighbour, remove the original median and associated reference from the parent.

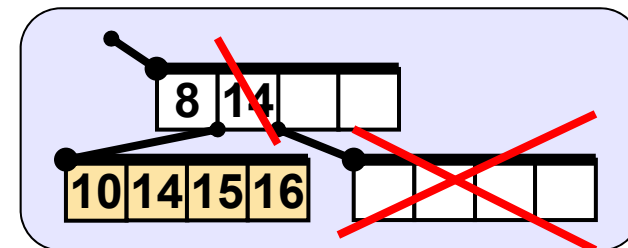
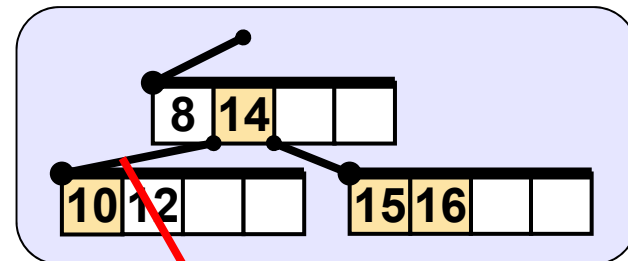

B tree - Delete

Multi phase strategy

Delete rules IV

15

Deleted 12

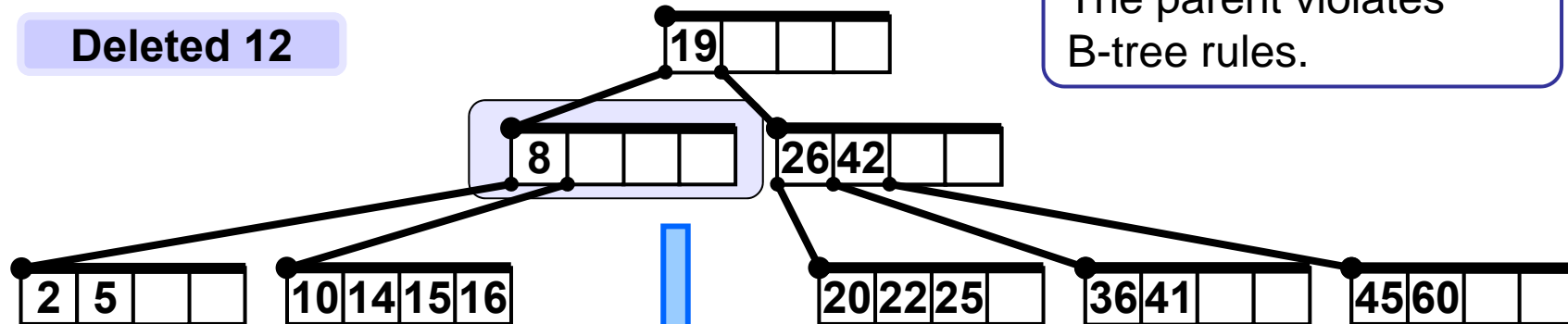

If the parent of the deleted node is not sufficiently full apply the same deleting strategy to the parent and continue the process towards the root until the rules of B-tree are satisfied.

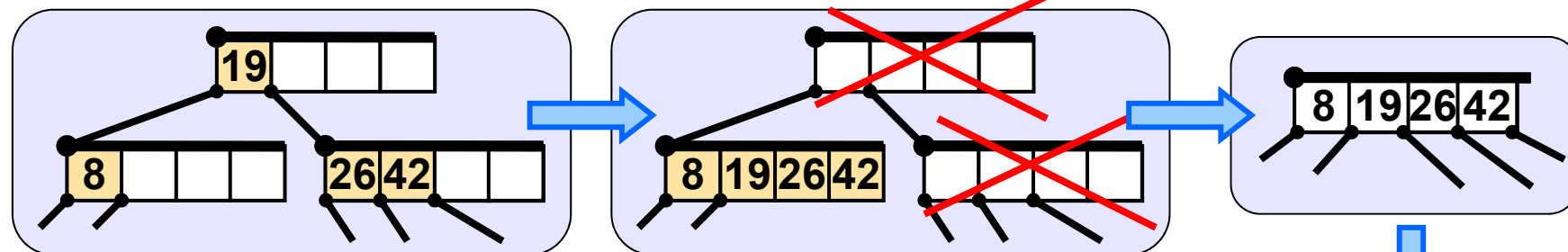

Multi phase strategy

Recapitulation - delete 12

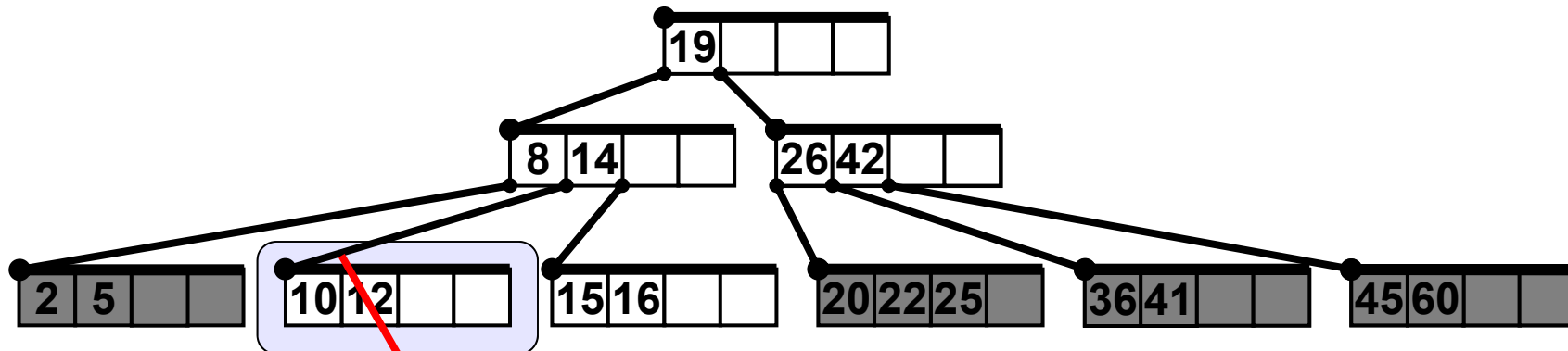

Key 12 was deleted and the tree was reconstructed accordingly.

Unaffected nodes

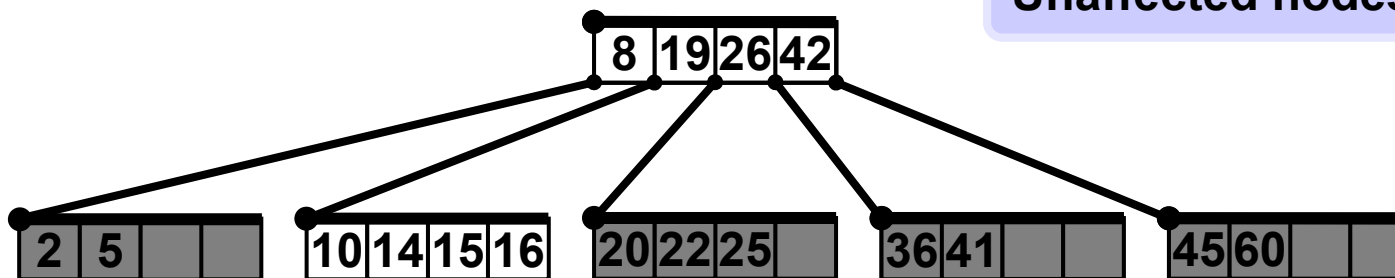

Single phase strategy

Cormen et al. 1990, $t = 3$, minimum degree 3, max degree = 6, minimum keys in node = 2, maximum keys in node = 5.

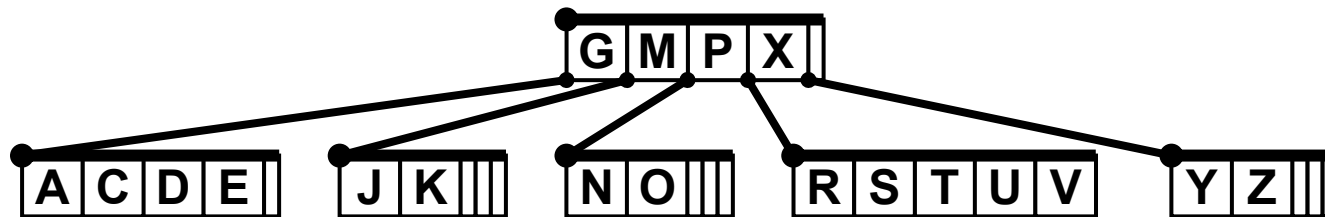

Insert B

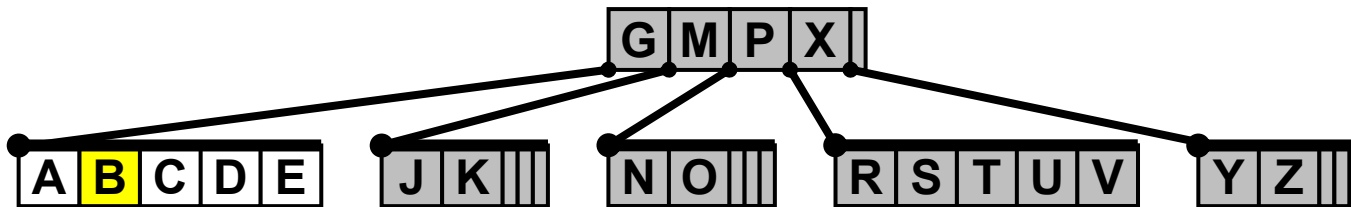

Insert Q

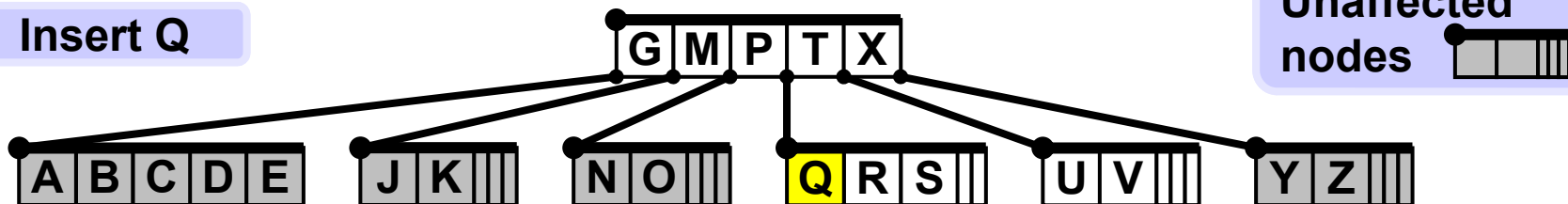

Single phase strategy

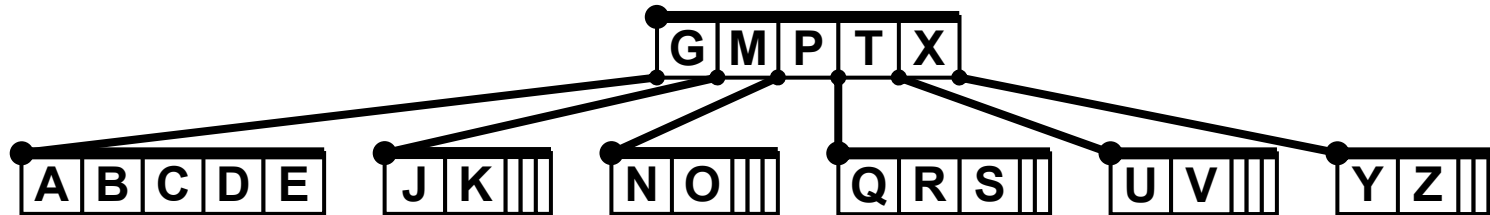

Single phase: Split the root, because it is full, and then continue downwards inserting L

Insert L

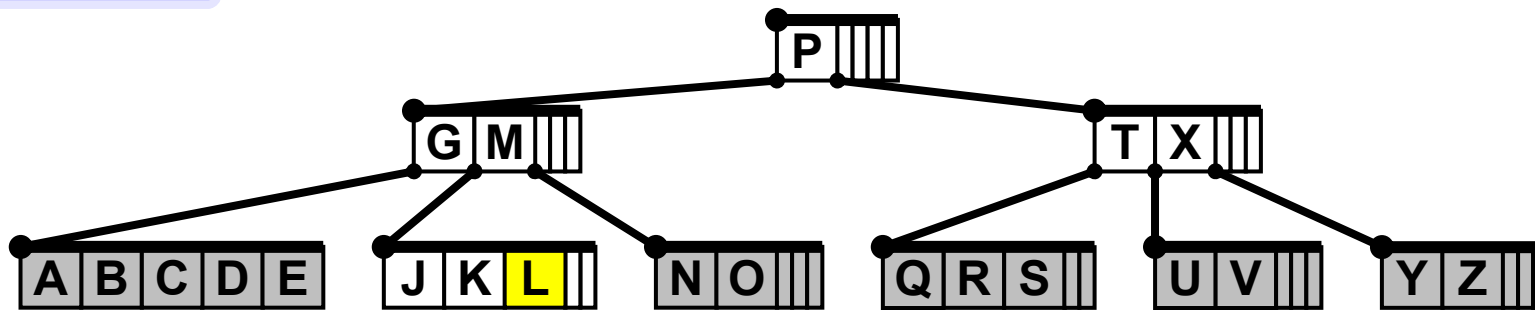

Insert F

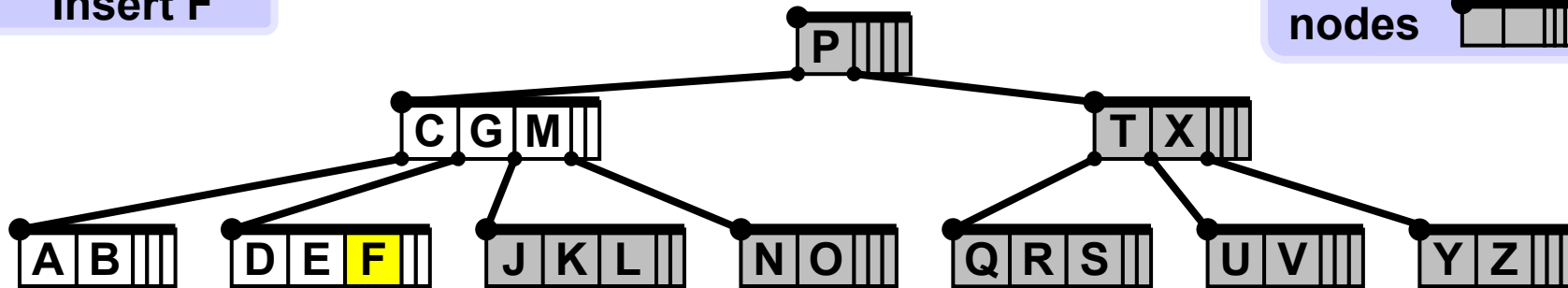

Unaffected nodes

Single phase strategy

Delete F

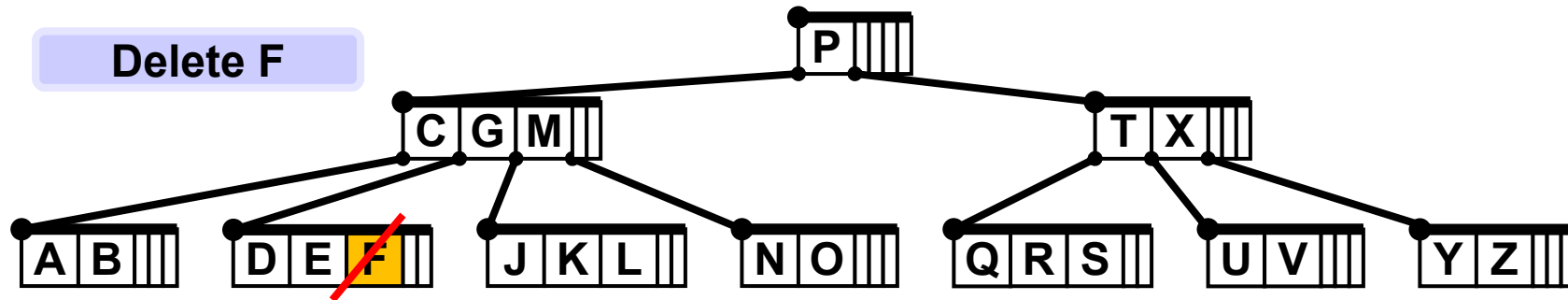

1. If the key k is in node X and X is a leaf, delete the key k from X .

Unaffected nodes

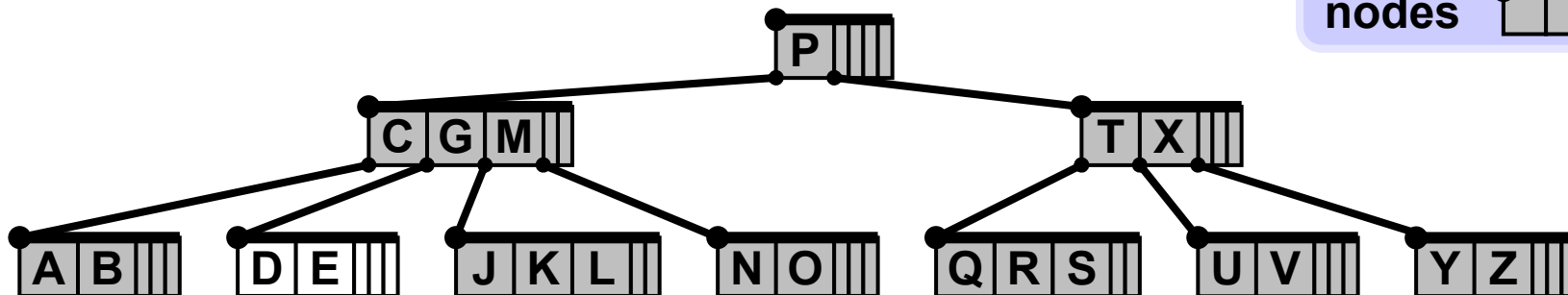

Single phase strategy

Delete M

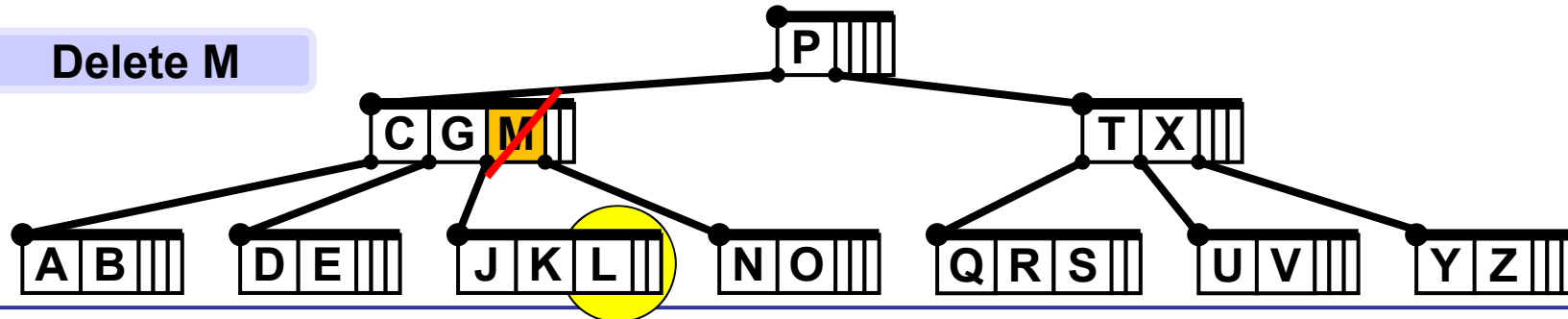

2. If the key k is in node X and X is an internal node, do the following:

2a. If the child Y that precedes k in node X has at least t keys, then find the predecessor k_p of k in the subtree rooted at Y . Recursively delete k_p , and replace k by k_p in X . (We can find k_p and delete it in a single downward pass.)

2b. If Y has fewer than t keys, then, symmetrically, examine the child Z that follows k in node X and continue as in 2a.

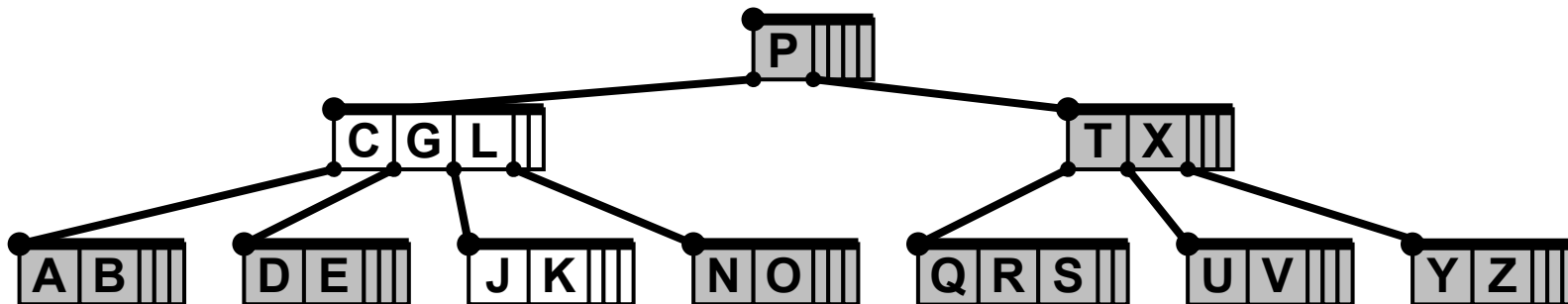

Single phase strategy

Delete G

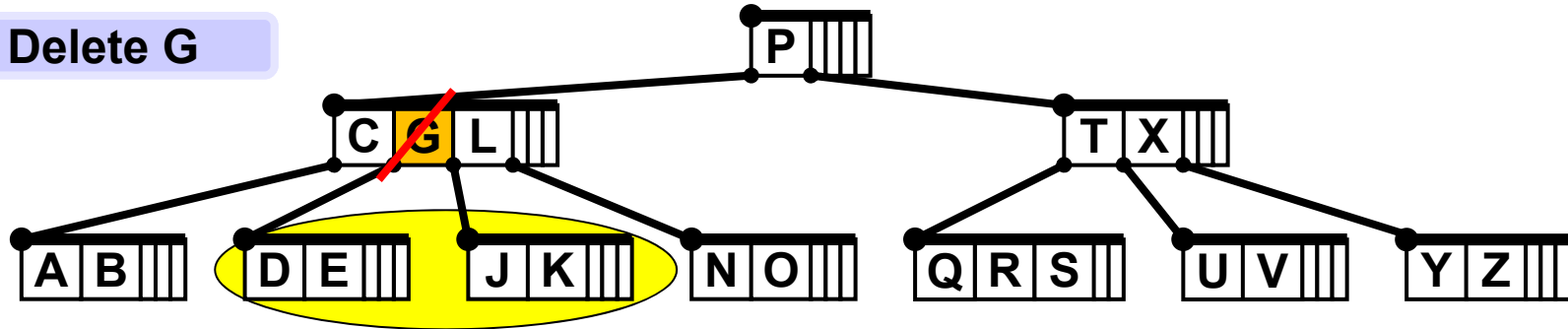

2c. Otherwise, i.e. if both **Y** and **Z** have only $t-1$ keys, merge **k** and all of **Z** into **Y**, so that **X** loses both **k** and the pointer to **Z**, and **Y** now contains $2t-1$ keys. Then free **Z** and recursively delete **k** from **Y**.

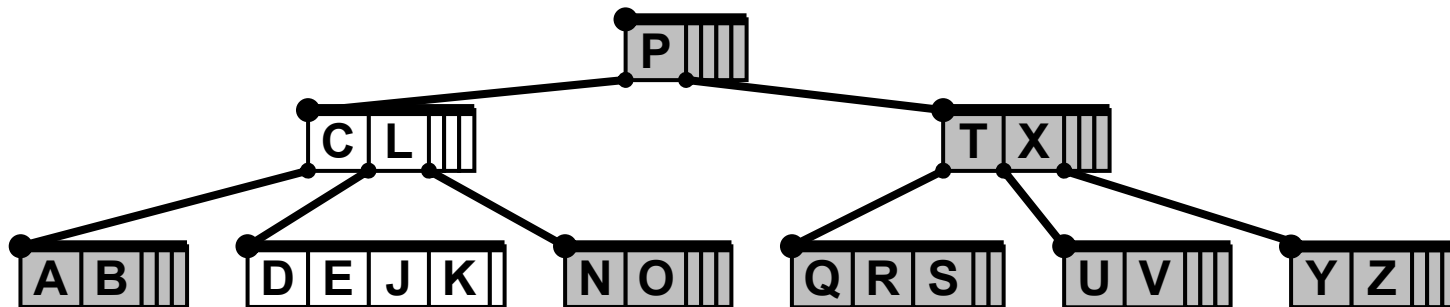

Single phase strategy

3. If the key k is not present in internal node X , determine the root $X.r$ of the appropriate subtree that must contain k , if k is in the tree at all. If $X.r$ has only $t-1$ keys, execute step 3a or 3b as necessary to guarantee that we descend to a node containing at least t keys. Then finish by recursing on the appropriate child of X .

Delete D

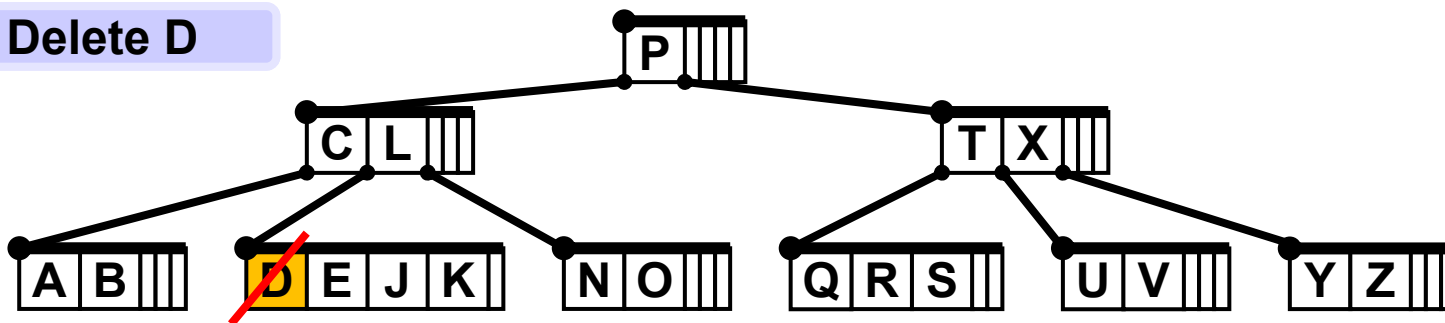

Single phase strategy

Delete D

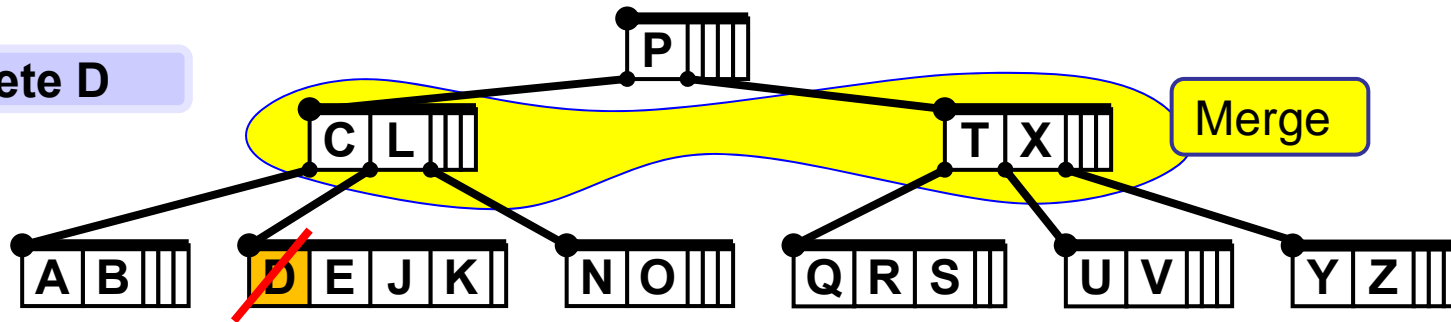

3a. If $X.r$ and both of $X.r$'s immediate siblings have $t-1$ keys, merge $X.r$ with one sibling, which involves moving a key from x down into the new merged node to become the median key for that node.

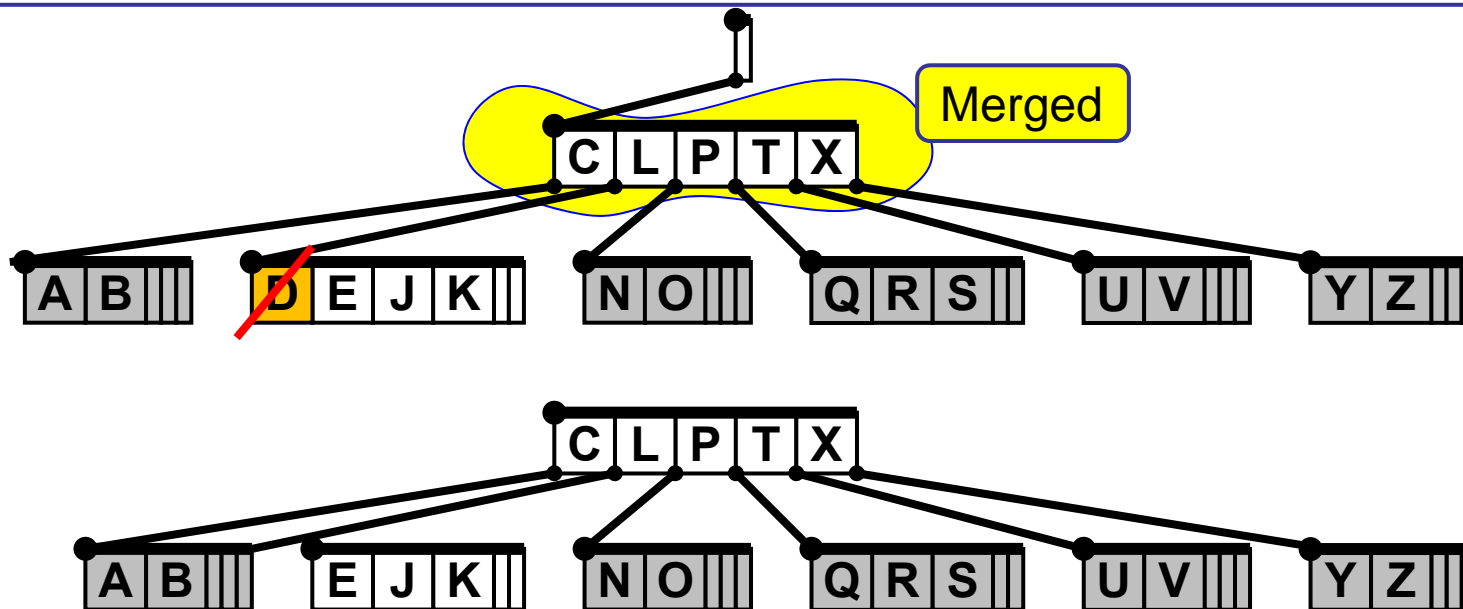

Single phase strategy

Delete B

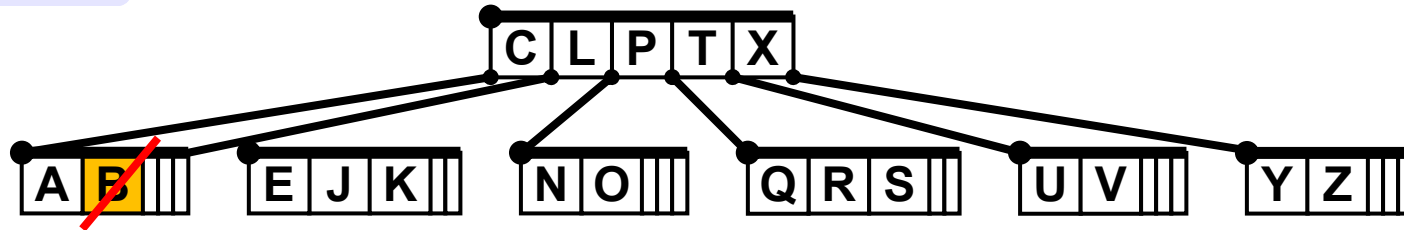

3b. If $X.r$ has only $t-1$ keys but has an immediate sibling with at least t keys, give $X.r$ an extra key by moving a key from X down into $X.r$, moving a key from $X.r$'s immediate left or right sibling up into X , and moving the appropriate child pointer from the sibling into $X.r$.

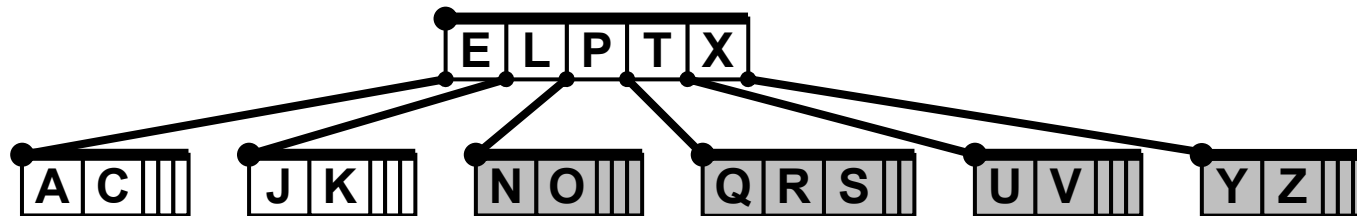

B+ tree

B+ tree is analogous to B-tree, namely in:

- Being perfectly balanced all the time,
- that nodes cannot be less than half full,
- operational complexity.

The differences are:

- Records (or pointers to actual records) are stored only in the leaf nodes,
- internal nodes store only search key values which are used only as routers to guide the search.

The leaf nodes of a B⁺-tree are linked together to form a linked list. This is done so that the records can be retrieved sequentially without accessing the B⁺-tree index. This also supports fast processing of range-search queries.

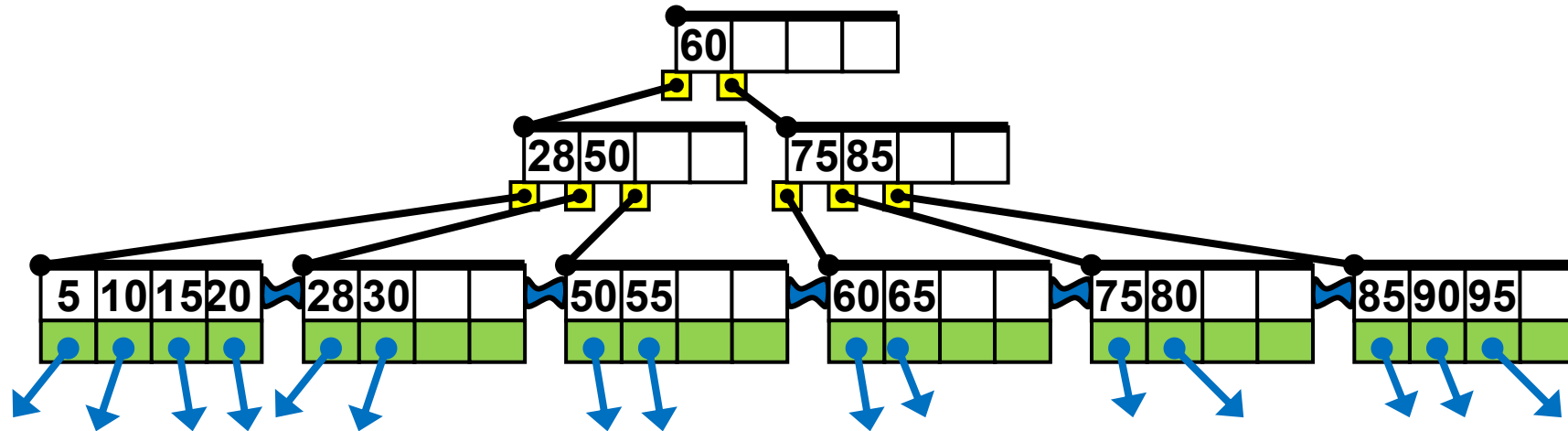

Routers and keys 75

Data records or pointers to them 

Leaves links 

Values in internal nodes are routers, originally each of them was a key when a record was inserted. Insert and Delete operations split and merge the nodes and thus move the keys and routers around. A router may remain in the tree even after the corresponding record and its key was deleted.

Values in the leaves are actual keys associated with the records and must be deleted when a record is deleted (their router copies may live on).

Inserting key K (and its associated data record) into B+ tree

Find, as in B tree, correct leaf to insert K. Then there are 3 cases:

Case 1

Free slot in a leaf? YES

Place the key and its associated record in the leaf.

Case 2

Free slot in a leaf? NO. Free slot in the parent node? YES.

1. Consider all keys in the leaf, including K, to be sorted.
2. Insert middle (median) key M in the parent node in the appropriate slot Y.
(If parent does not exist, first create an empty one = new root.)
3. Split the leaf into two new leaves L1 and L2.
4. Left leaf (L1) from Y contains records with keys smaller than M.
5. Right leaf (L2) from Y contains records with keys **equal to or greater than M**.

Note: Splitting leaves and inner nodes works in the same way as in B-trees.

Inserting key K (and its associated data record) into B+ tree

Find, as in B tree, correct leaf to insert K. Then there are 3 cases:

Case 3

Free slot in a leaf? NO. Free slot in the parent node? NO.

1. Split the leaf to two leaves L1 and L2, consider all its keys including K sorted, denote M median of these keys.
2. Records with keys $< M$ go to the left leaf L1.
3. Records with keys $\geq M$ go to the right leaf L2.

4. Split the parent node P to nodes P1 and P2, consider all its keys including M sorted, denote M1 median of these keys.
5. Keys $< M1$ key go to P1.
6. Keys $\geq M1$ key go to P2.
7. If parent PP of P is not full, insert M1 to PP and stop.
(If PP does not exist, first create an empty one = new root.)
Else set $M := M1$, $P := PP$ and continue splitting parent nodes recursively up the tree, repeating from step 4.

Initial tree

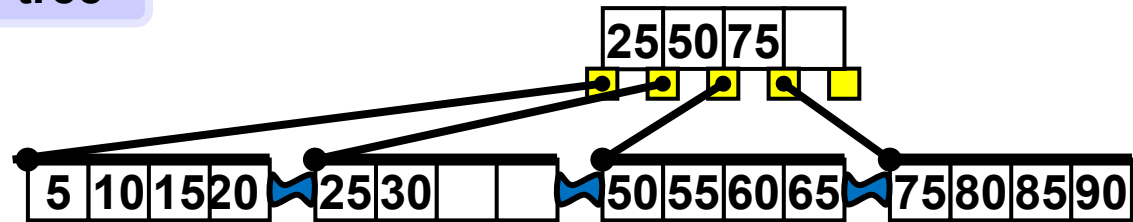

Insert 28

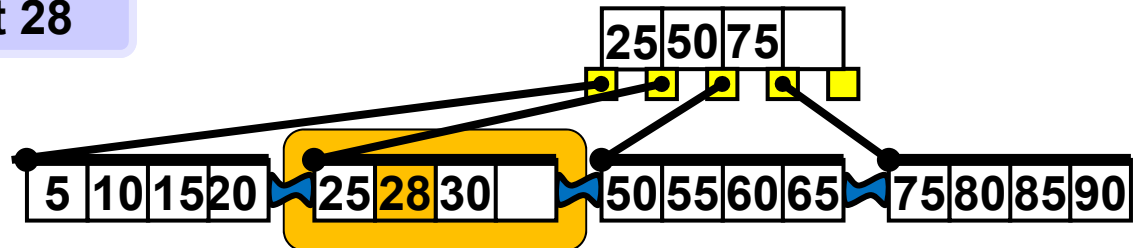

Changes



Leaves links



Data records and pointers to them are not drawn here for simplicity's sake.

Initial tree

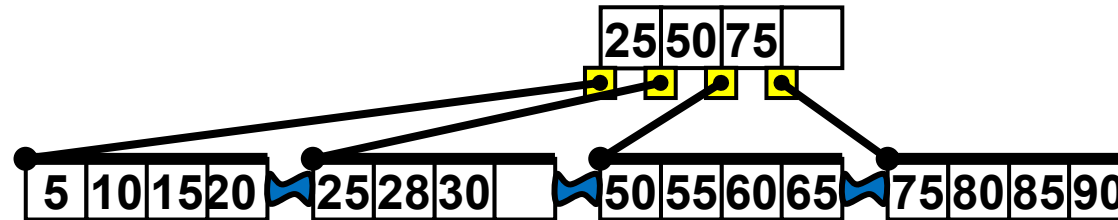

Insert 70

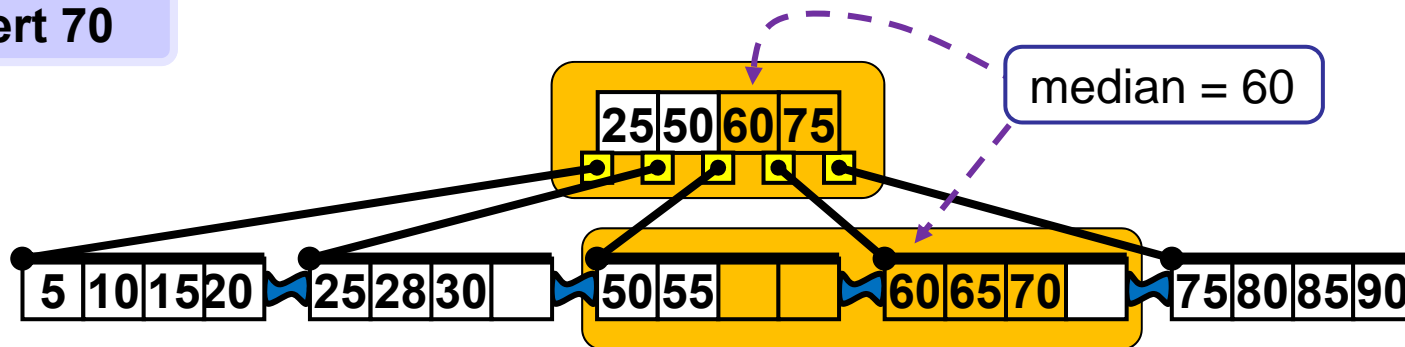

Changes 

Leaves links 

Initial tree

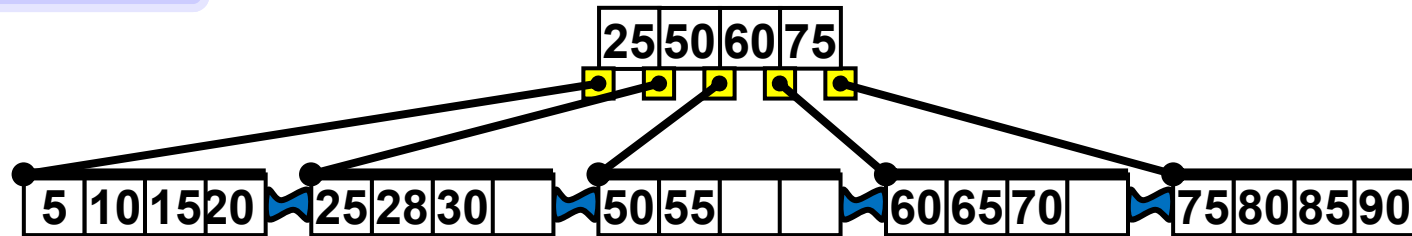

Insert 95

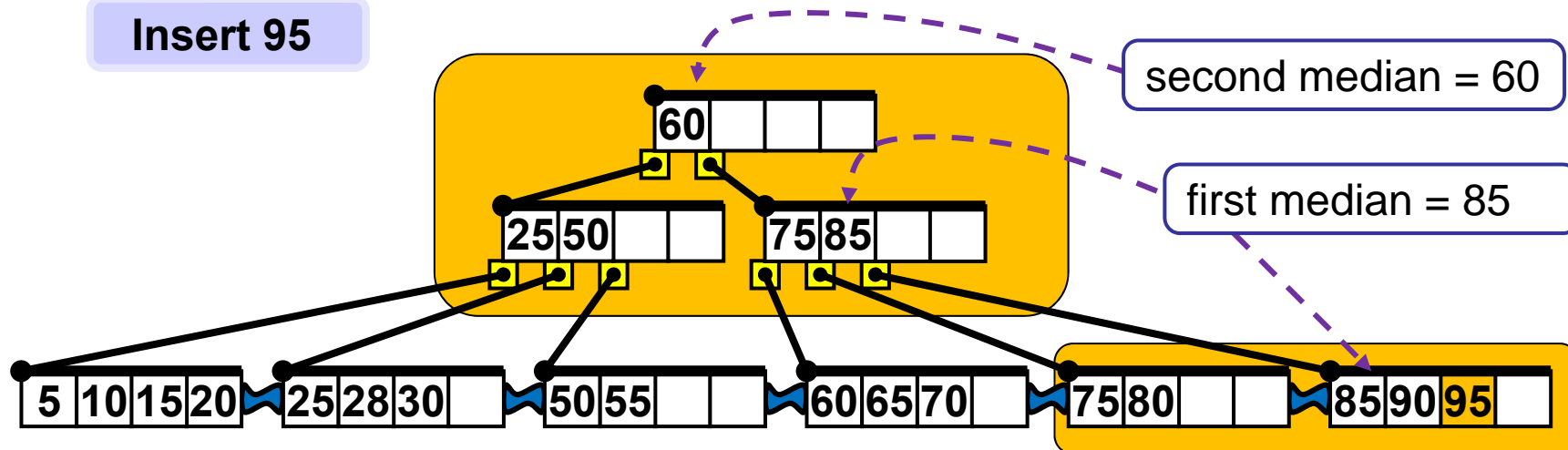

Changes 

Leaves links 

Note the router 60 in the root, detached from its original position in the leaf.

Deleting key K (and its associated data record) in B+ tree

Find, as in B tree, key K in a leaf. Then there are 3 cases:

Case 1

Leaf more than half full or leaf == root? YES.

Delete the key and its record from the leaf L. Arrange the keys in the leaf in ascending order to fill the void. If the deleted key K appears also in the parent node P replace it by the next bigger key K1 from L (explain why it exists) and leave K1 in L as well.

Case 2

Leaf more than half full? NO. Left or right sibling more than half full? YES.

Move one (or more if you wish and rules permit) key from sibling S to the leaf L, reflect the changes in the parent P of L and parent P2 of sibling S. (If S does not exist then L is the root, which may contain any number of keys).

Deleting key K (and its associated data record) in B+ tree

Find, as in B tree, key K in a leaf. Then there are 3 cases:

Case 3

Leaf more than half full? NO. Left or right sibling more than half full? NO.

1. Consider sibling S of L which has the same parent P as L.
2. Consider set M of ordered keys of L and S without K but together with key K1 in P which separates L and S.
3. Merge: Store M in L, connect L to the other sibling of S (if exists), destroy S.
4. Set the reference left to K1 to point to L. Delete K1 from P. If P contains K delete it also from P. If P is still at least half full stop, else continue with 5.
5. If any sibling SP of P is more than half full, move necessary number of keys from SP to P and adjust links in P, SP and their parents accordingly and stop. Else set $L := P$ and continue recursively up the tree (like in B-tree), repeating from step 1.

Note: Merging leaves and inner nodes works the same way as in B-trees.

Initial tree

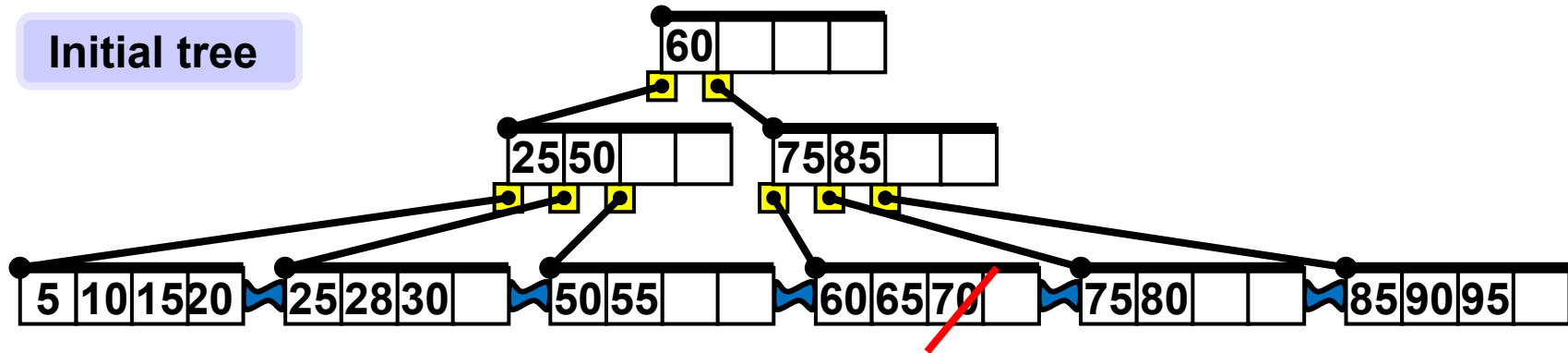

Delete 70

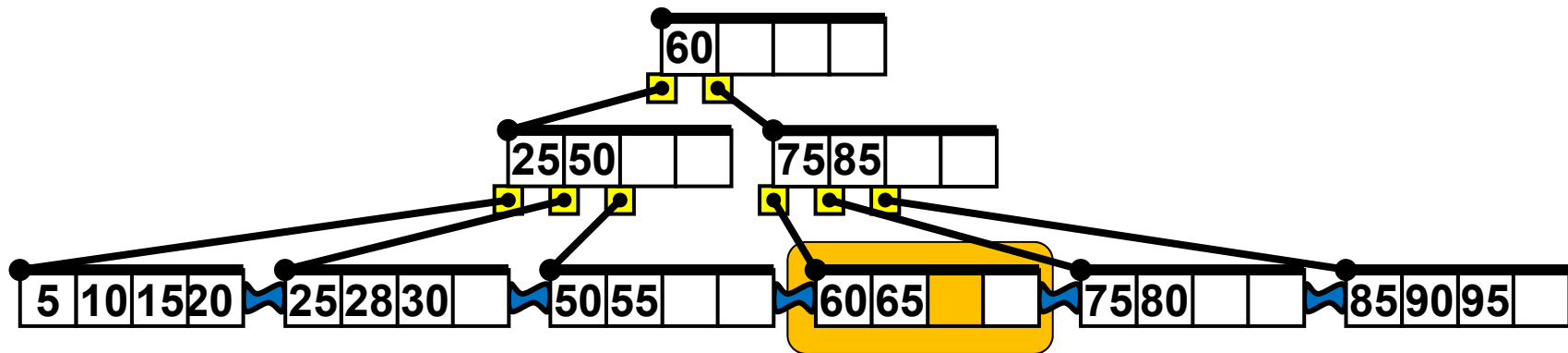

Changes 

Leaves links 

Initial tree

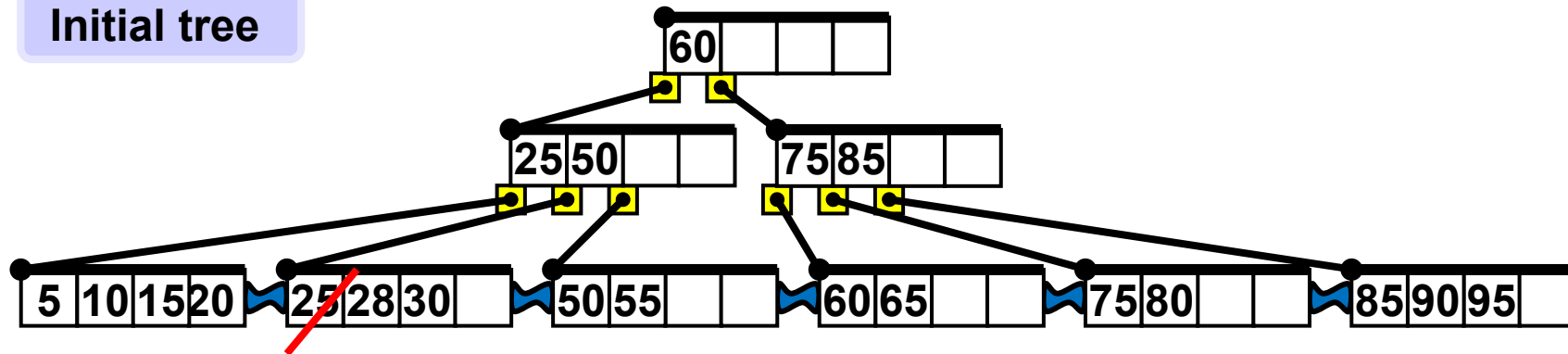

Delete 25

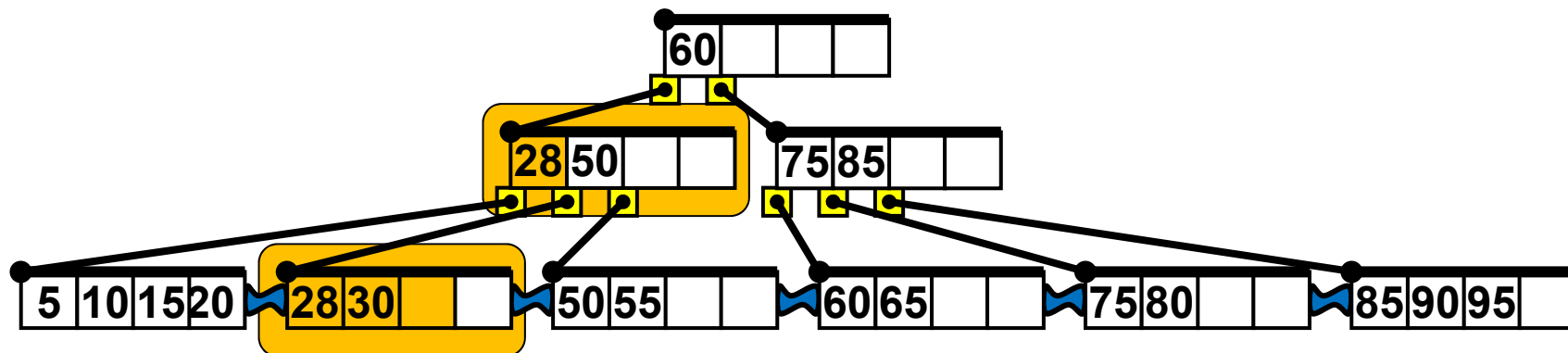

Changes 

Leaves links 

Initial tree

Delete 60

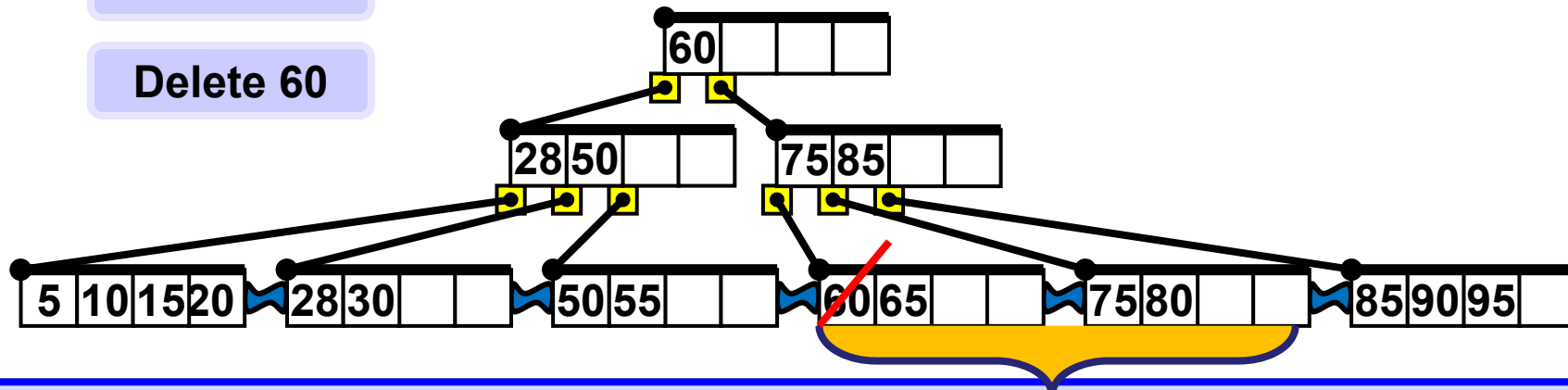

Merge

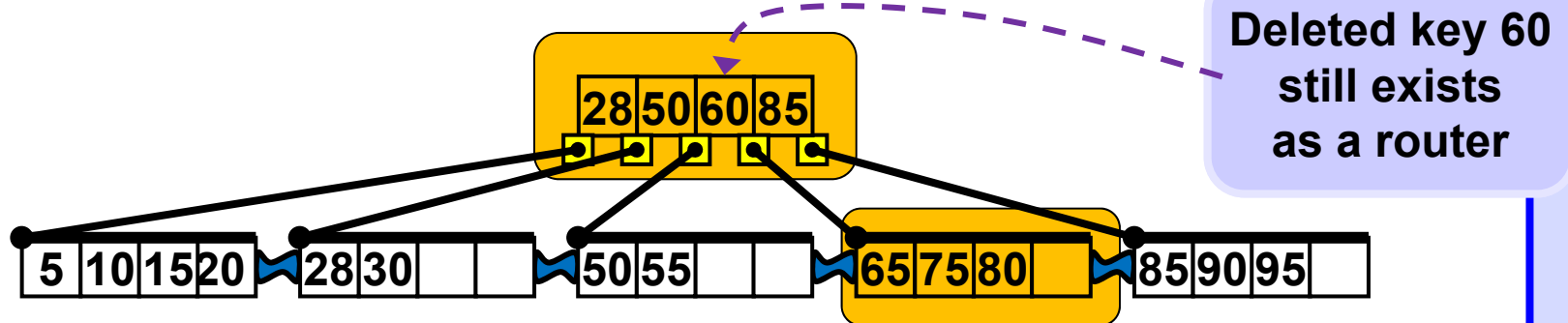

Changes 

Leaves links 

Initial tree

Delete 75

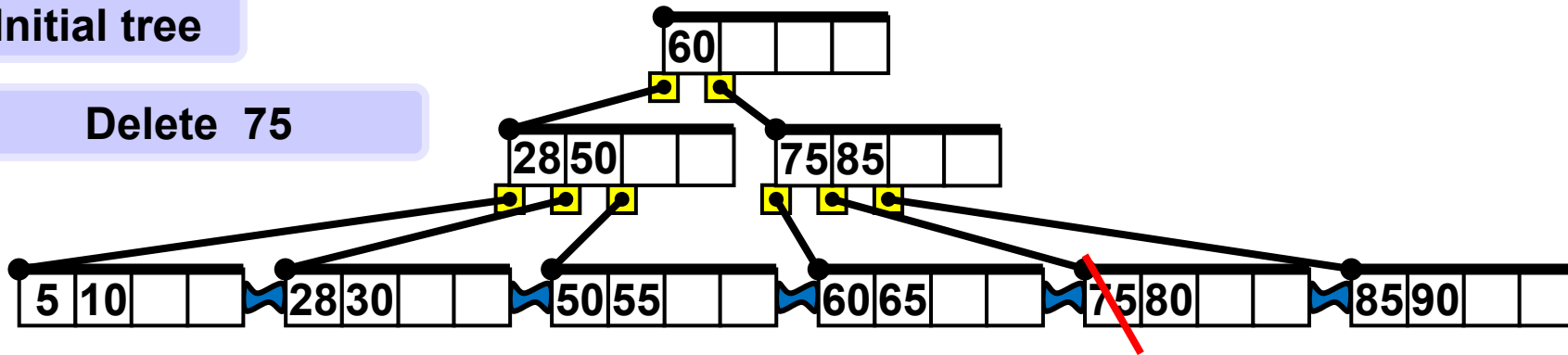

Too few keys, merge these two nodes and bring a key from parent (recursively).

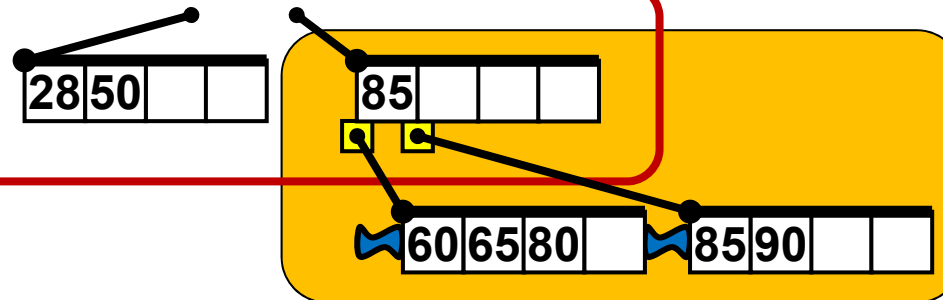

Progress...

... done.

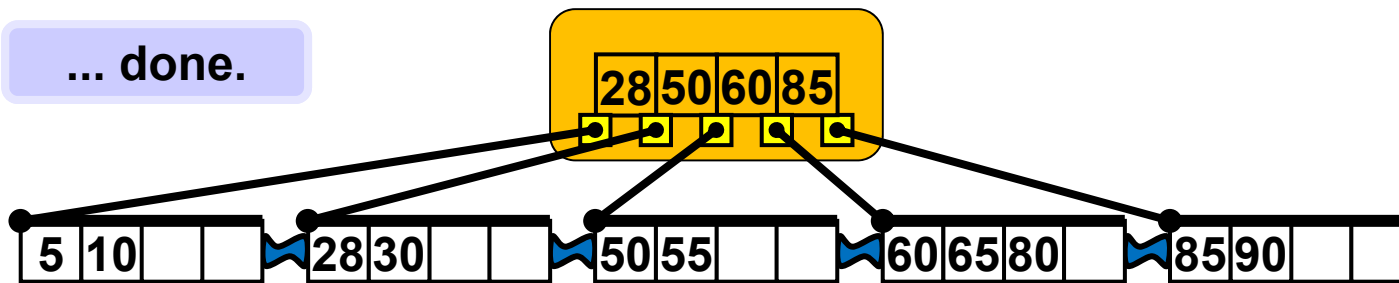

Complexities

Find, Insert, Delete,
all need $\Theta(b \log_b n)$ operations, where n is number of records in the tree,
and b is the branching factor or, as it is often understood, the order of the tree.

Note: Be careful, some authors (e.g CLRS) define degree/order of B-tree as $\lfloor b/2 \rfloor$, there is no unified precise common terminology.

Range search thanks to the linked leaves is performed in time
 $\Theta(b \log_b(n) + k/b)$
where k is the range (number of elements) of the query.