



DCGI

DEPARTMENT OF COMPUTER GRAPHICS AND INTERACTION

CONVEX HULL IN 3 DIMENSIONS

PETR FELKEL

FEL CTU PRAGUE

felkel@fel.cvut.cz

<https://cw.felk.cvut.cz/doku.php/courses/a4m39vg/start>

Based on [Berg], [Preparata], [Rourke] and [Boissonnat]

Version from 12.11.2019

Talk overview

- Upper bounds for convex hull in 2D and 3D
- Other criteria for CH algorithm classification
- Recapitulation of CH algorithms
- Terminology refresh
- Convex hull in 3D
 - Terminology
 - Algorithms
 - Gift wrapping
 - D&C Merge
 - Randomized Incremental

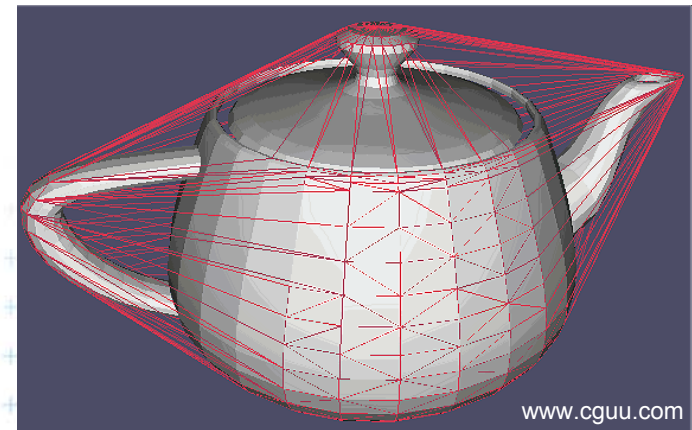

Upper bounds for Convex hull algorithms

- $O(n)$ for **sorted points** and for simple polygon
- $O(n \log n)$ in E^2, E^3 with **sorting**
 - insensitive about output
- $O(n h), O(n \log h)$, h is number of CH facets
 - output sensitive
 - $O(n^2)$ or $O(n \log n)$ for $n \sim h$
- $O(\log n)$ for new point insertion in realtime algs.
 - $\Rightarrow O(n \log n)$ for n -points
 - $O(\log n)$ search where to insert



Other criteria for CH algorithm classification

- Optimality – depends on data order (or distribution)
 - In the worst case x In the expected case
- Output sensitivity – depends on the result $\sim O(f(h))$
- Extendable to higher dimensions?
- Off-line versus on-line
 - **Off-line** – all points available, preprocessing for search speedup
 - **On-line** – stream of points, new point p_i on demand, just one new point at a time, CH valid for $\{p_1, p_2, \dots, p_i\}$
 - **Real-time** – points come as they “want”
(come not faster than optimal constant $O(\log n)$ inter-arrival delay)
- Parallelizable x serial
- Dynamic – points can be deleted

■ Deterministic x approximate (lecture 13)



Graham scan

- $O(n \log n)$ time and $O(n)$ space is
 - optimal in the worst case
 - not optimal in average case (not output sensitive)
 - only 2D
 - off-line
 - serial (not parallel)
 - not dynamic (no deleted points)

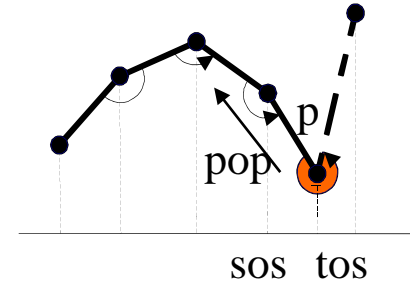

$O(n)$ for polygon (discussed in seminar)



Jarvis March – Gift wrapping

- $O(hn)$ time and $O(n)$ space is
 - not optimal in worst case $O(n^2)$
 - may be optimal if $h \ll n$ (output sensitive)
 - 3D or higher dimensions (see later)
 - off-line
 - serial (not parallel)
 - not dynamic

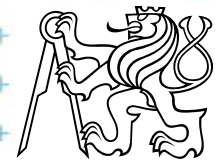
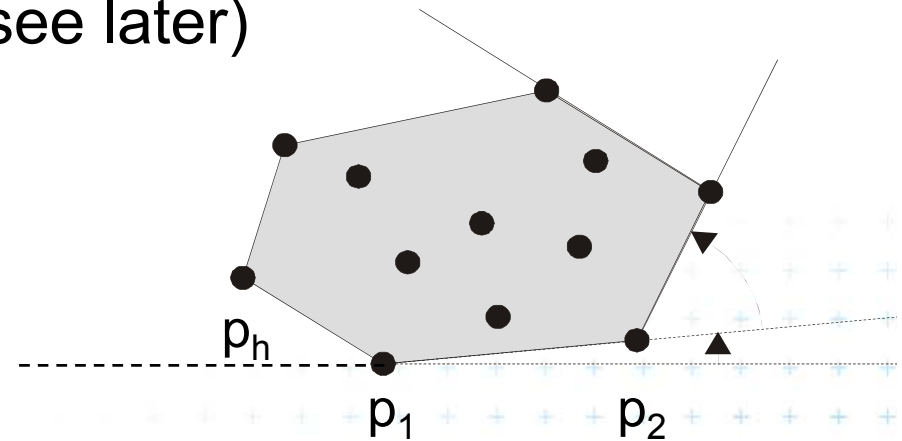

Divide & Conquer

- $O(n \log n)$ time and $O(n)$ space is
 - optimal in worst case (in 2D or 3D)
 - not optimal in average case (not output sensitive)
 - 2D or 3D (circular ordering), in higher dims not optimal
 - off-line
 - Version with sorting (the presented one) – serial
 - Parallel for overlapping merged hulls (see Chapter 3.3.5 in Preparata for details)
 - not dynamic

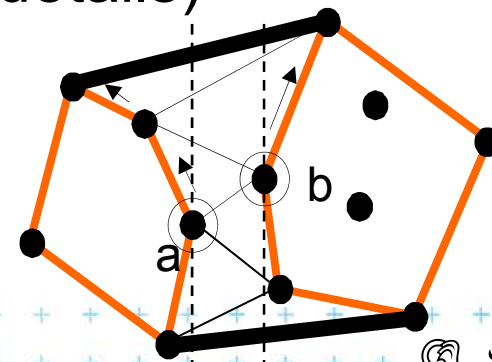

Quick hull

- $O(n \log n)$ expected time, $O(n^2)$ the worst case and $O(n)$ space *in 2D* is
 - not optimal in worst case $O(n^2)$
 - optimal if uniform distribution then $h \ll n$ (output sensitive)
 - 2D, or higher dimensions [see <http://www.qhull.org/>]
 - off-line
 - parallelizable
 - not dynamic

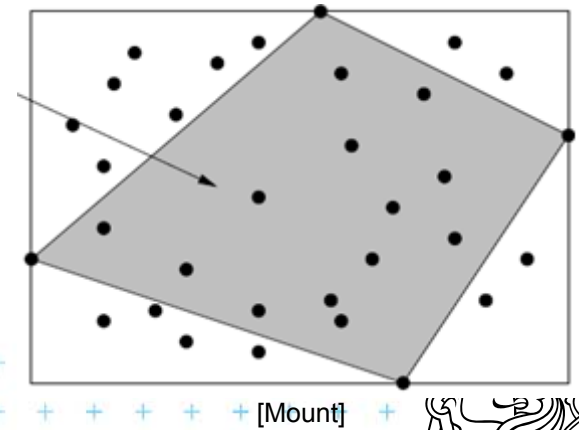

Chan

- $O(n \log h)$ time and $O(n)$ space is
 - optimal for h points on convex hull (output sensitive)
 - 2D and 3D --- gift wrapping
 - off-line
 - Serial (not parallel)
 - not dynamic

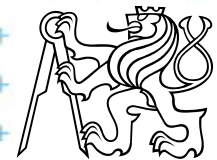
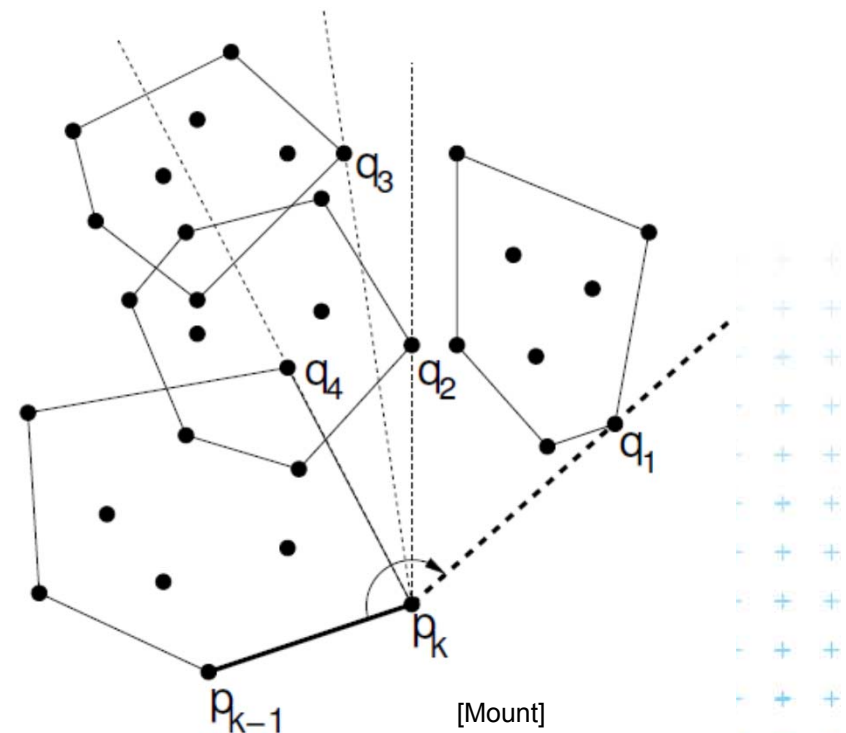

On-line algorithms

- Preparata's on-line algorithm
- Overmars and van Leeuwen



Preparata's 2D on-line algorithm

- New point p is tested
 - Inside → ignored
 - Outside → added to hull
 - Find left and right **supporting lines** (touch at supporting points)
 - Remove points between supporting points
 - Add p to CH between supporting lines

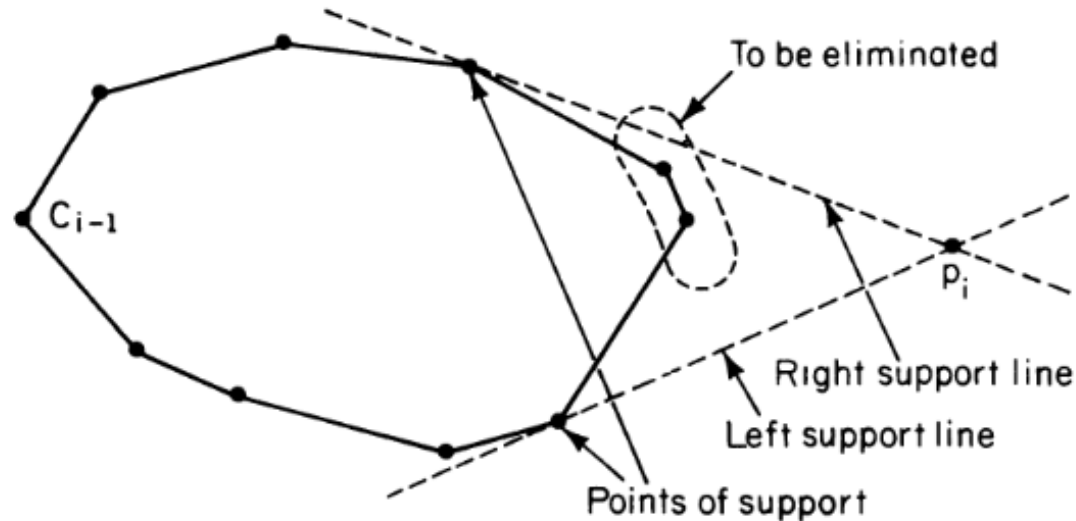

[Preparata]



Preparata's 2D on-line algorithm

- Optimal if concatenable tree for CH – $O(n \log n)$
 - $O(n^2)$ if CH in list using sequential search for point of support
- Output sensitive – not
- 2D
- On-line (incremental, randomized)
off-line if sorted points and local search of eliminated faces
- Serial
- Not-dynamic

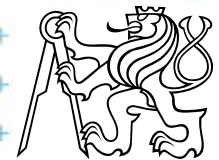

Overmars and van Leeuwen

- Allow dynamic 2D CH (on-line insert & delete)
- Manage special tree with all intermediate CHs
- Will be discussed on seminar [7]

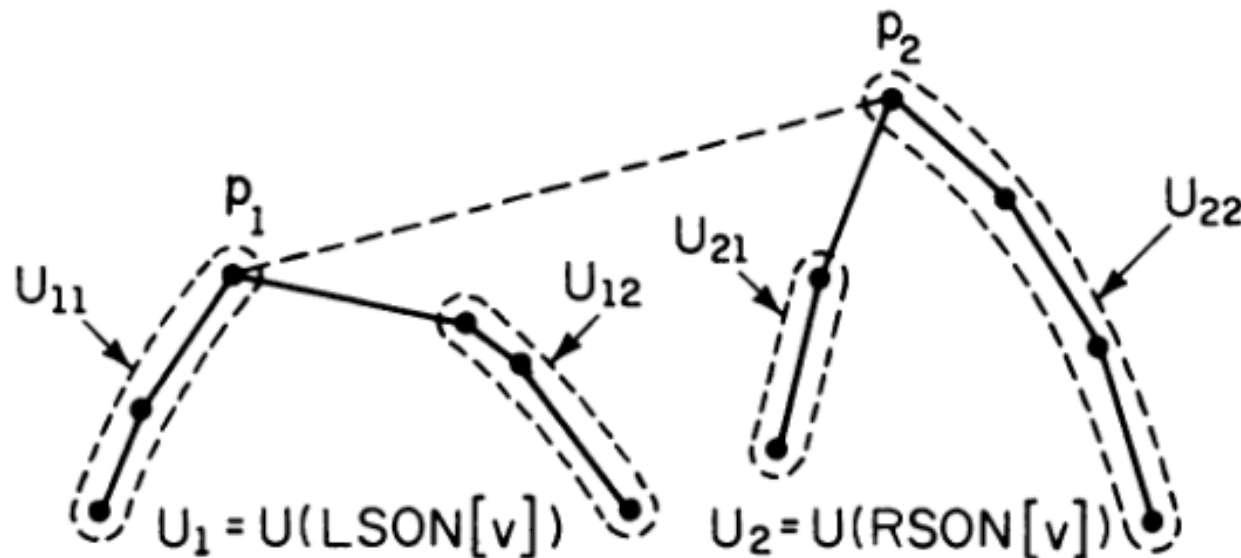

[Preparata]

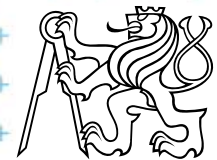

-
- Optimal ($O(\log n)$ split and merge – up and down)
(using concatenable queues for CH's)
 - 2d
 - On line
 - Serial
 - DYNAMIC



Convex hull in 3D

- Terminology
- Algorithms
 1. Gift wrapping
 2. D&C Merge
 3. Randomized Incremental
 4. Quick hull ... minule

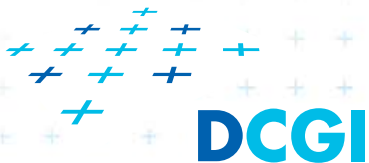

Terminology

- **Polytope** (d-polytope)
= a geometric object with "flat" sides E^d
(may be or may not be convex)
- Flat sides mean that
the sides of a (k) -polytope
consist of $(k-1)$ -polytopes that
may have $(k-2)$ -polytopes in common.

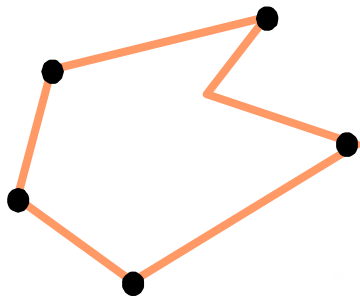

2-polytop
= polygon

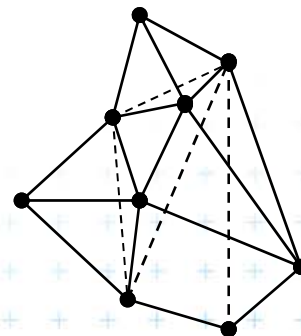

3-polytop
= polyhedron



Terminology

- **Convex Polytope** (convex d -polytope)
= convex hull of finite set of points in E^d

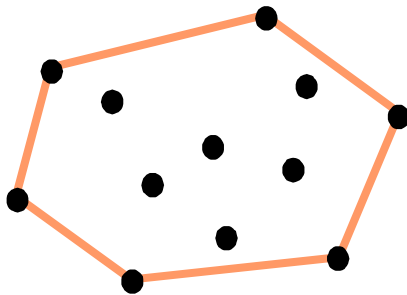

convex
2-polytop

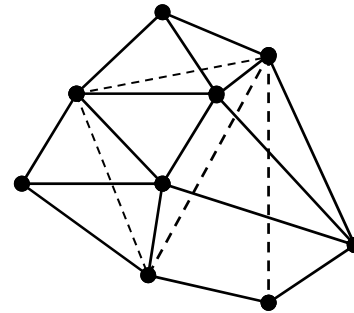

convex
3-polytop

- **Simplex** (k -simplex, d -simplex)
= CH of $k + 1$ *affine independent points*

(vectors $(p_k - p_0)$ are linearly independent)

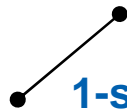

1-simplex

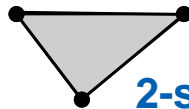

2-simplex

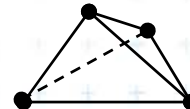

3-simplex

= “Special” Convex Polytope with all the points on the CH



Terminology (2)

- Affine combination**

= linear combination of the points $\{p_1, p_2, \dots, p_n\}$ whose coefficients $\{\lambda_1, \lambda_2, \dots, \lambda_n\}$ **sum to 1**, and $\lambda_i \in \mathbb{R}$

$$\sum_{i=1}^n \lambda_i p_i$$

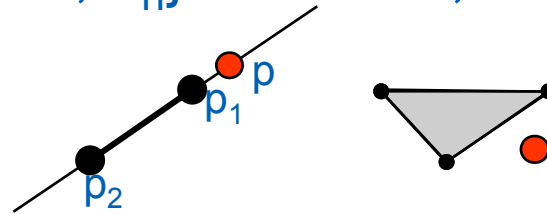

- Affine independent points**

= no one point can be expressed as affine combination of the others



- Convex combination**

= linear combination of the points $\{p_1, p_2, \dots, p_n\}$ whose coefficients $\{\lambda_1, \lambda_2, \dots, \lambda_n\}$ **sum to 1**, and $\lambda_i \in \mathbb{R}^+_0$ (i.e., $\forall i \in \{1, \dots, n\}, \lambda_i \geq 0$) $\Rightarrow \lambda_i \in \langle 0, 1 \rangle$

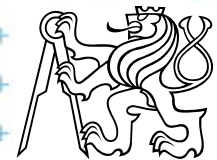
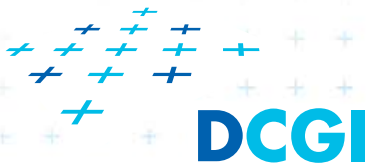

Terminology (3)

- Any $(d-1)$ -dimensional hyperplane h divides the space into (open) halfspaces h^+ and h^- , so that $E^n = h^+ \cup h \cup h^-$
- Def: $\overline{h^+} = h^+ \cup h$, $\overline{h^-} = h^- \cup h$ (closed halfspaces)
- Hyperplane supports a convex polytope P (Supporting hyperplane – *opěrná nadrovina*)
 - if $h \cap P$ is not empty and
 - if P is entirely contained within either $\overline{h^+}$ or $\overline{h^-}$

In 2D:

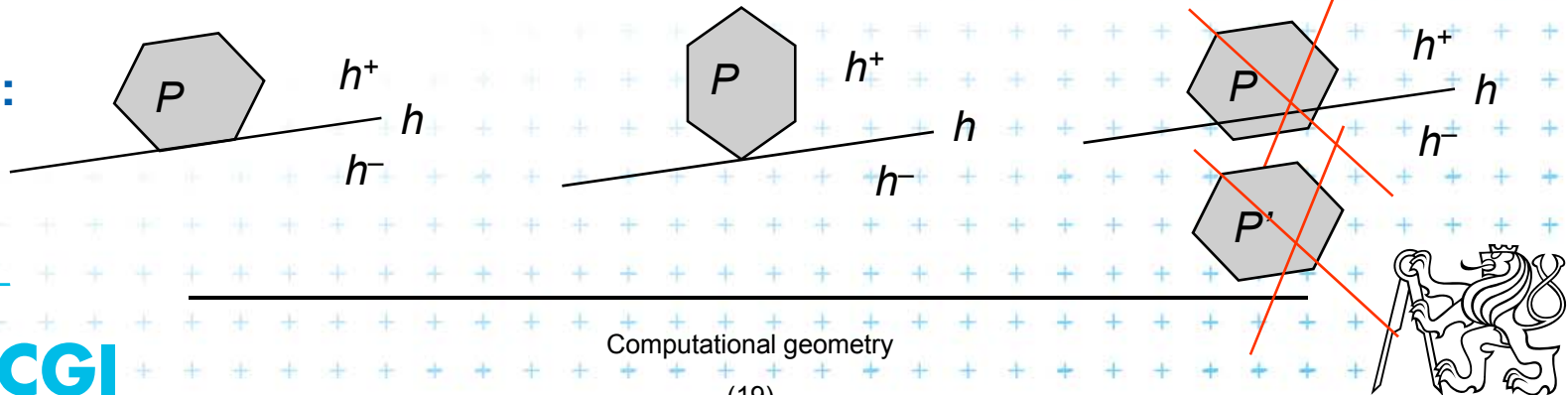

Faces and facets

- **Face** of the convex polytope
= Intersection of convex polytope P
with a supporting hyperplane h
 - Faces are convex polytopes of dimension d ranging from 0 to $d - 1$
 - 0-face = **vertex**
 - 1-face = **edge**
 - $(d - 1)$ -face = **facet**

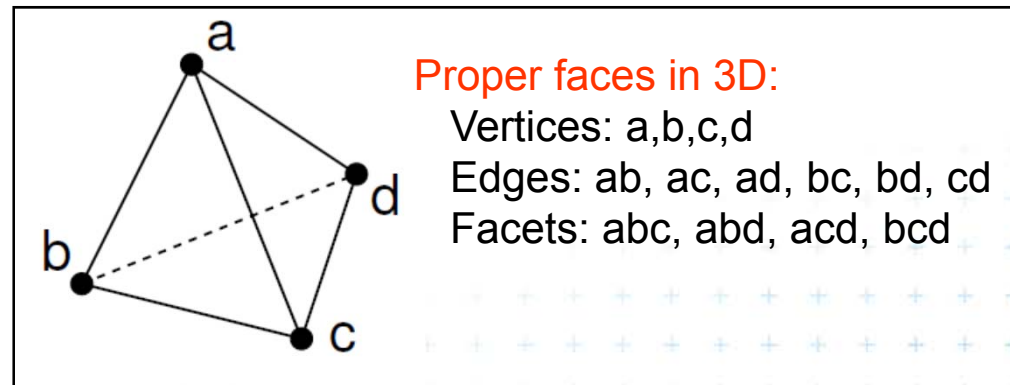

In 3D we often say *face*, but more precisely a **facet**

(In 3D a 2-face = facet)

(In 2D a 1-face = facet)



Proper faces

- Proper faces

= Faces of dimension d ranging from 0 to $d - 1$

- Improper faces

= proper faces + two additional faces:

- $\{\}$ = Empty set = face of dimension -1
- Entire convex polytope = face of dimension d

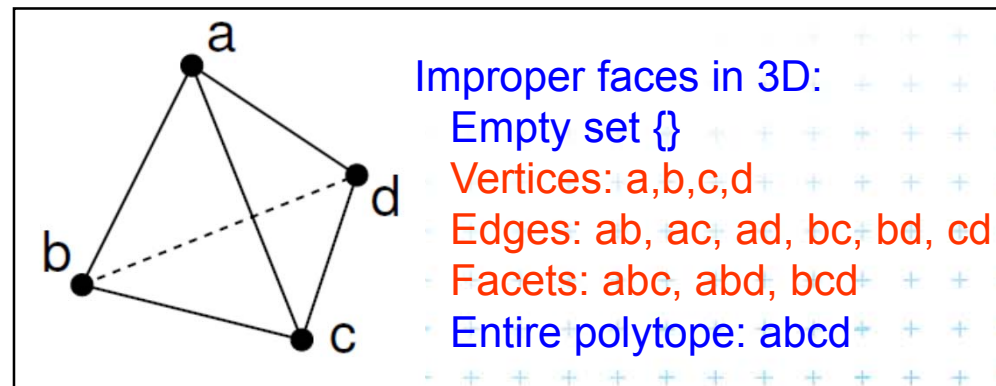

Incident graph

- Stores **topology of the polytope**
- Ex: 3-simplex:

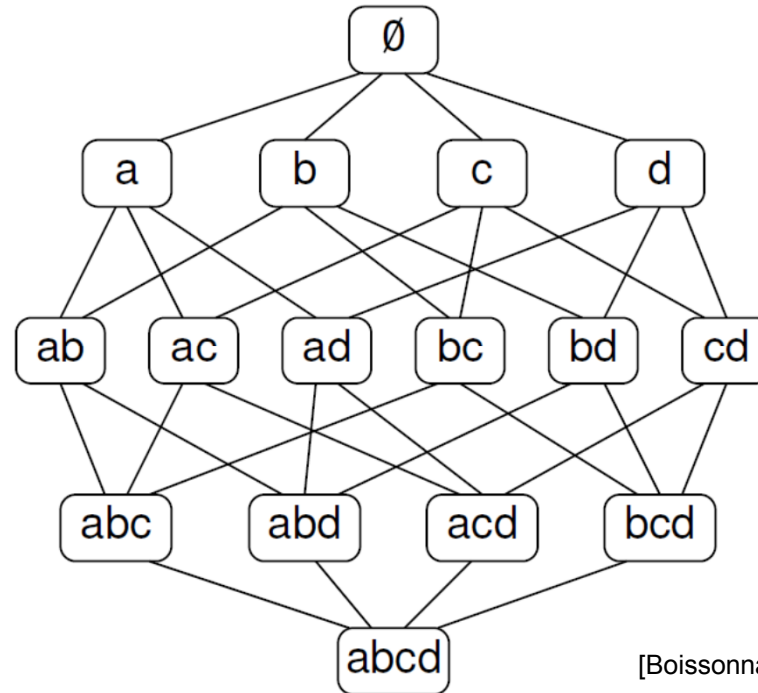
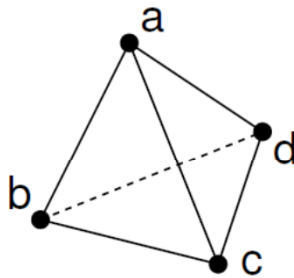

[Boissonnat]

Dimension

-1

0

1

2

3

- **d-simplex is a very regular face structure:**
 - 1-face for each pair of vertices
 - 2-face for each triple of vertices



Facts about polytopes

- Boundary of polytope is *union of its proper faces*
- Polytope has *finite number of faces (next slide)*.
Each face is a polytope
- Convex polytope is *convex hull of its vertices (the def)*, its bounded
- Convex polytope is the *intersection of finite number of closed halfspaces $\overline{h^+}$*
(conversely not: intersection of closed halfspaces may be unbounded => called *unbounded polytope*)

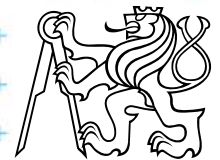
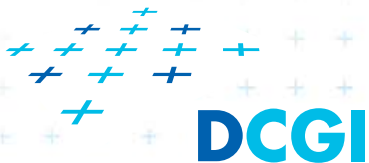

Number of faces on a d-simplex

- Number of j -dimensional faces on a d -simplex

$$\binom{d+1}{j+1} = \frac{(d+1)!}{(j+1)!(d-j)!}$$

- Ex.: Tetrahedron = 3-simplex:

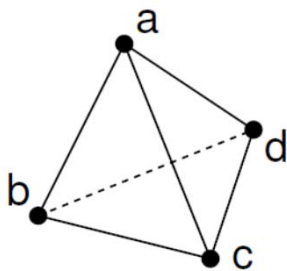

- facets (2-dim. faces) $\binom{3+1}{2+1} = \frac{4!}{3!1!} = 4$

- edges (1-dim. faces) $\binom{3+1}{1+1} = \frac{4!}{2!2!} = 6$

- vertices (0-dim faces) $\binom{3+1}{0+1} = \frac{4!}{1!3!} = 4$



Complexity of 3D convex hull is $O(n)$

- 3-polytope - has polygonal faces
- convex 3-polytope (CH of a point set in 3D)
- simplicial 3-polytope
 - has triangular faces (\Rightarrow more edges and faces)
- **simplicial convex 3-polytope** with all n points on CH
 - the worst case complexity
 - \Rightarrow maximum # of edges and faces for given points
 - has triangular facets, each generates 3 edges, shared by 2 triangles $\Rightarrow 3F = 2E$ 2-manifold

$$F = 2V - 4 \quad \Rightarrow \quad F \leq 2V - 4 \quad F = O(n)$$

$$E = 3V - 6 \quad \Rightarrow \quad E \leq 3V - 6 \quad E = O(n)$$

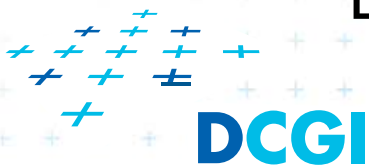

Complexity of 3D convex hull is $O(n)$

- The worst case complexity \rightarrow if all n points on CH

\Rightarrow use **simplicial convex 3-polytop** for complexity derivation

1. has all points on its surface – on the Convex Hull
2. has triangular facets, each generates 3 edges, shared by 2 triangles $\Rightarrow 3F = 2E$

2-manifold \leftarrow $F = 2E / 3$

- $V - E + F = 2$... Euler formula for $V = n$ points

$$V - E + 2E/3 = 2$$

$$V - 2 = E / 3$$

$$E = 3V - 6, \quad V = n$$

$$E = O(n)$$

$$F = 2E / 3$$

$$F = 2V - 4$$

$$F = O(n)$$



1. Gift wrapping in higher dimensions

- First known algorithm for n -dimensions (1970)
- Direct extension of 2D alg.
- Complexity $O(nF)$
 - F is number of CH facets
 - Algorithm is output sensitive
 - Details on seminar, assignment [10]

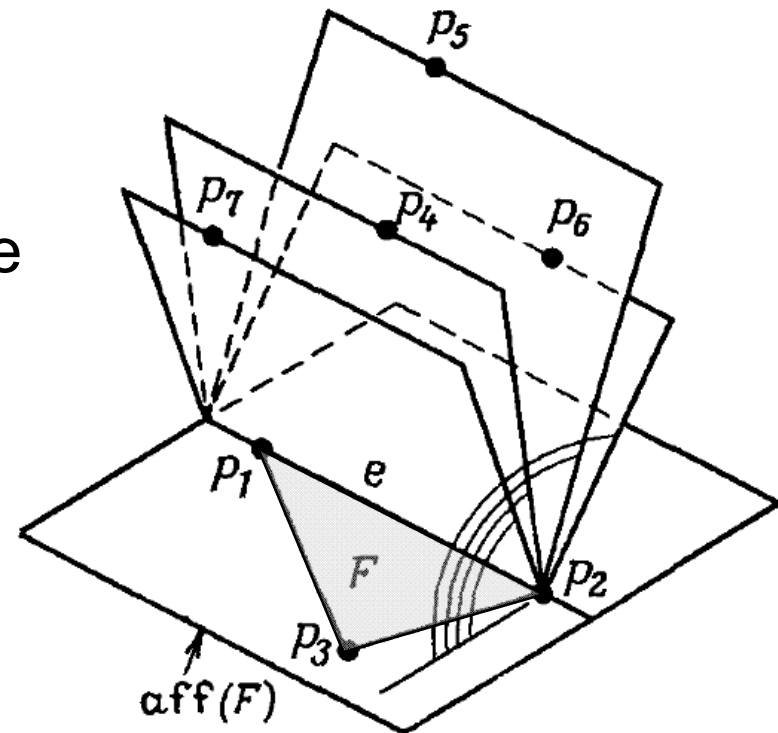

[Preparata]

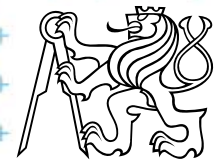

1. Gift wrapping in higher dimensions

- First known algorithm for n -dimensions (1970)
- Direct extension of 2D alg.
- Complexity $O(nF)$
 - F is number of CH facets
 - Algorithm is output sensitive
 - Details on seminar, assignment [10]

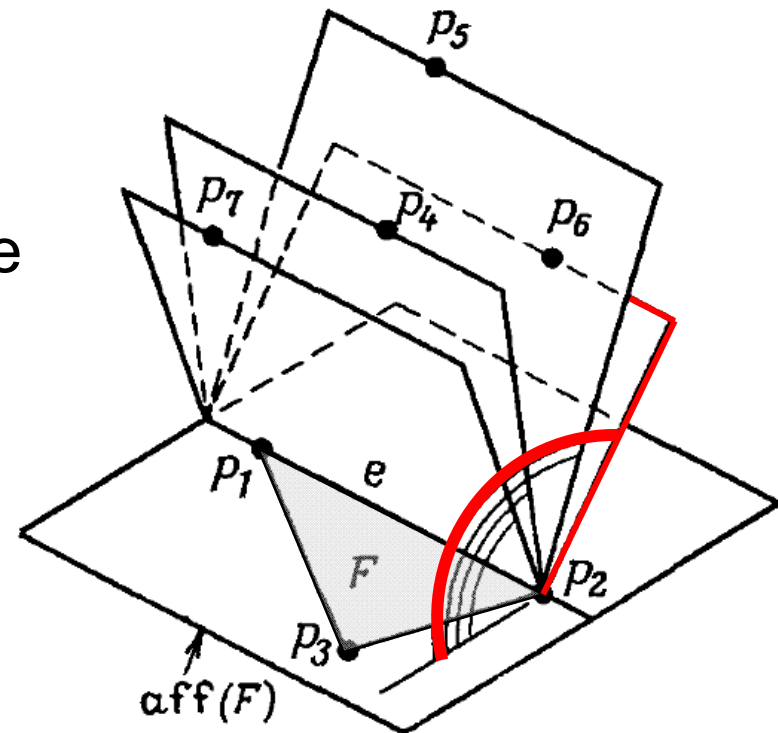

[Preparata]

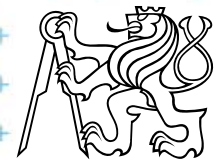

1. Gift wrapping in higher dimensions

- First known algorithm for n -dimensions (1970)
- Direct extension of 2D alg.
- Complexity $O(nF)$
 - F is number of CH facets
 - Algorithm is output sensitive
 - Details on seminar, assignment [10]

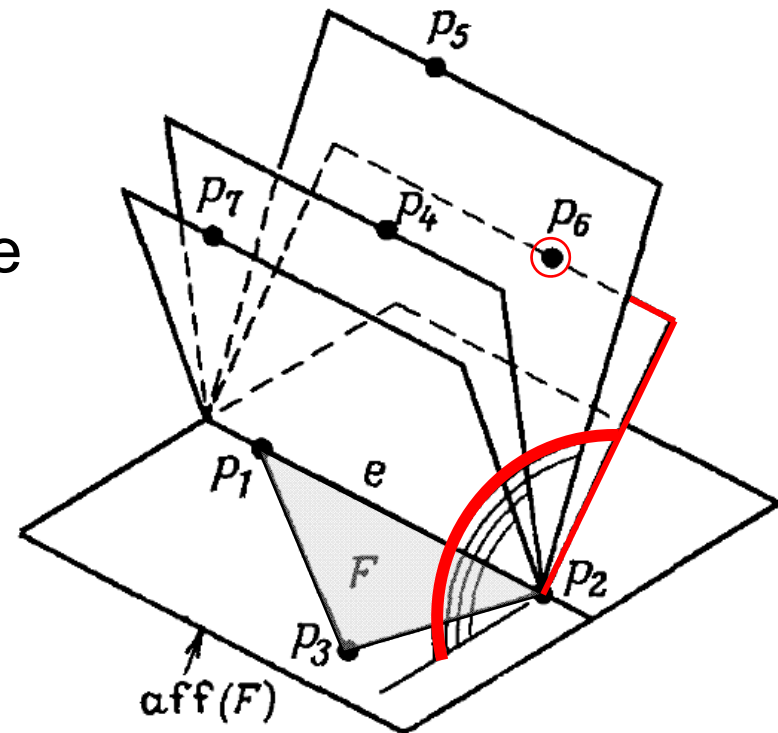

[Preparata]



2. Divide & conquer 3D convex hull [Preparata, Hong77]

- Sort points in x-coord
- Recursively split, construct CH, merge
- Merge takes $O(n) \Rightarrow O(n \log n)$ total time

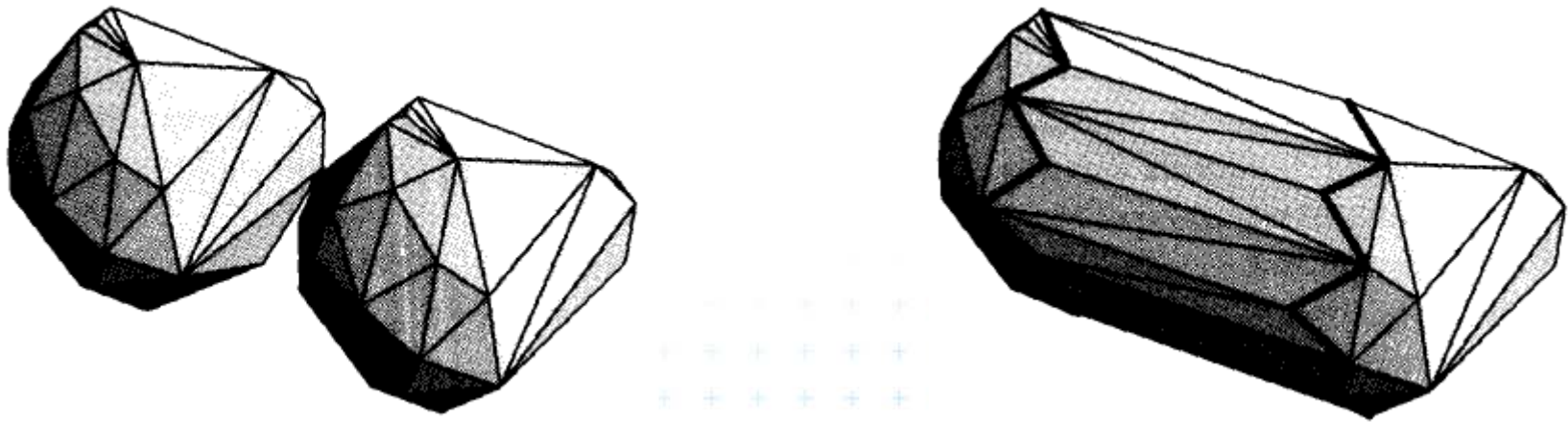

[Rourke]



Divide & conquer 3D convex hull

[Preparata, Hong 77]

- Merge(C_1 with C_2) uses gift wrapping
 - Gift wrap plane around edge e – find new point p on C_1 or on C_2 (neighbor of a or b)
 - Search just the CW or CCW neighbors around a, b

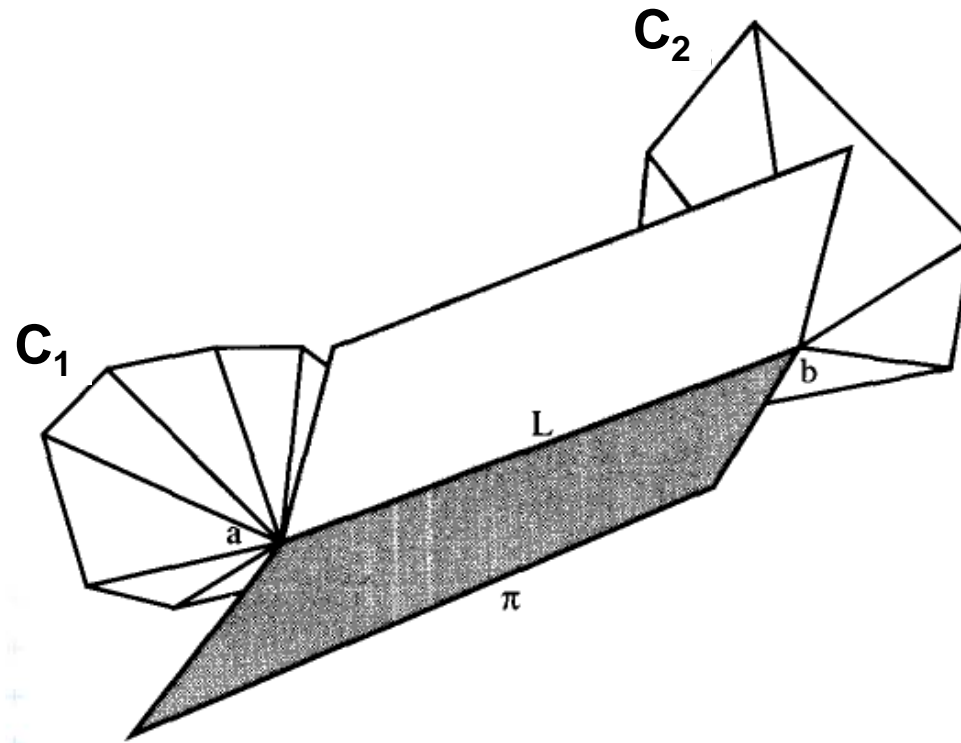

[Rourke]

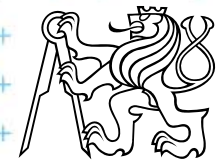

Divide & conquer 3D convex hull

[Preparata, Hong 77]

- Performance $O(n \log n)$ rely on circular ordering
 - In 2D: Ordering of points around CH
 - In 3D: Ordering of vertices around 2-polytop C_0 (vertices on intersection of new CH edges with separating plane H_0) [ordering around horizon of C_1 and C_2 does not exist, as both horizons may be non-convex and even not simple polygons]
 - In $\geq 4D$: Such ordering does not exist

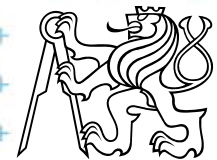
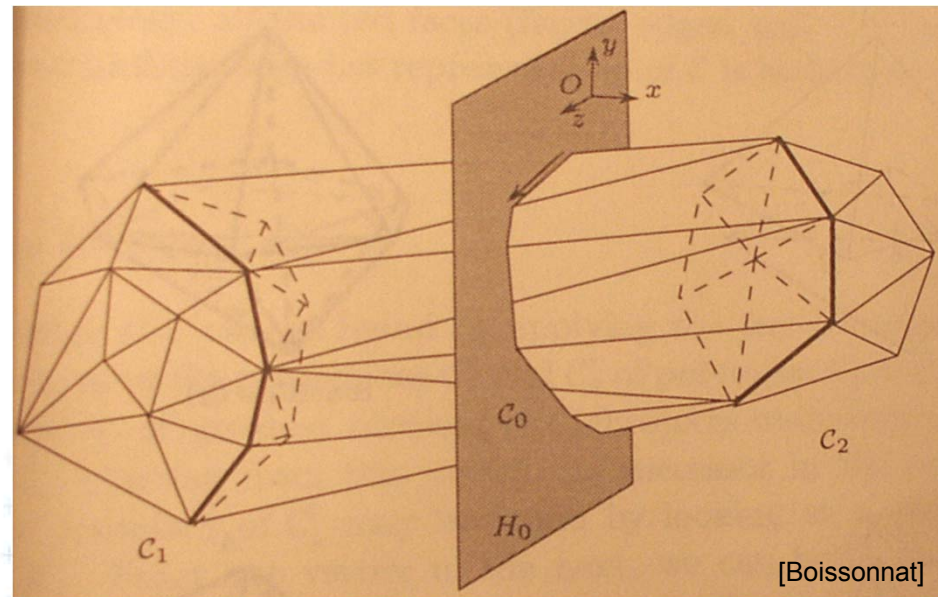

Divide & conquer 3D convex hull

[Preparata, Hong 77]

Merge(C_1 with C_2)

- Find the **first CH edge** L connecting C_1 with C_2
- $e = L$
- While not back at L do
 - store e to C
 - Gift wrap plane around edge e – find **new point** P on C_1 or on C_2 (neighbor of a or b)
 - $e =$ **new edge** to just found end-point P
 - Store **new triangle** eP to C
- Discard hidden faces inside CH from C
- Report **merged convex hull** C

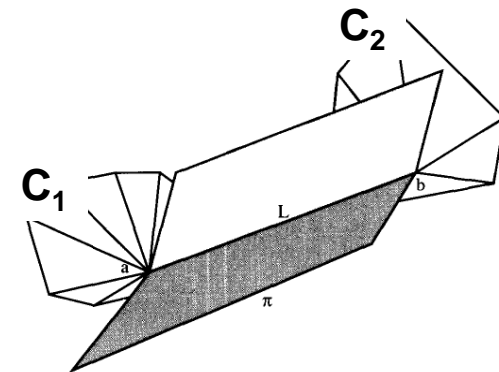

Divide & conquer 3D convex hull

[Preparata, Hong 77]

Merge(C_1 with C_2)

- Find the **first CH edge** L connecting C_1 with C_2
- $e = L$
- While not back at L do **CHYBA**
 - store e to C
 - Gift wrap plane around edge e – find **new point** P on C_1 or on C_2 (neighbor of a or b)
 - $e =$ **new edge** to just found end-point P
 - Store **new triangle** eP to C
- Discard hidden faces inside CH from C
- Report **merged convex hull** C

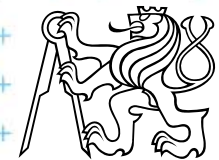
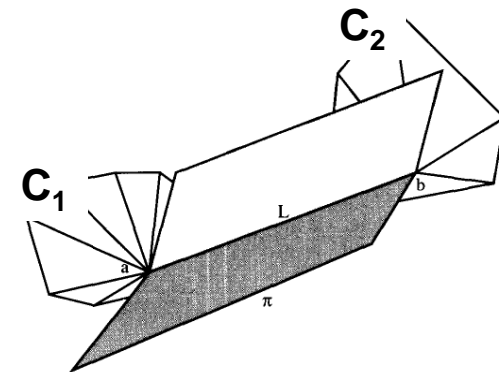

Divide & conquer 3D convex hull

[Preparata, Hong 77]

■ Problem of the wrapping phase [Edelsbrunner 88]

- The edges on horizon do not form simple circle but a “barbell” 0,2,4,0,1,3,5,1

Do not stop here! ↑

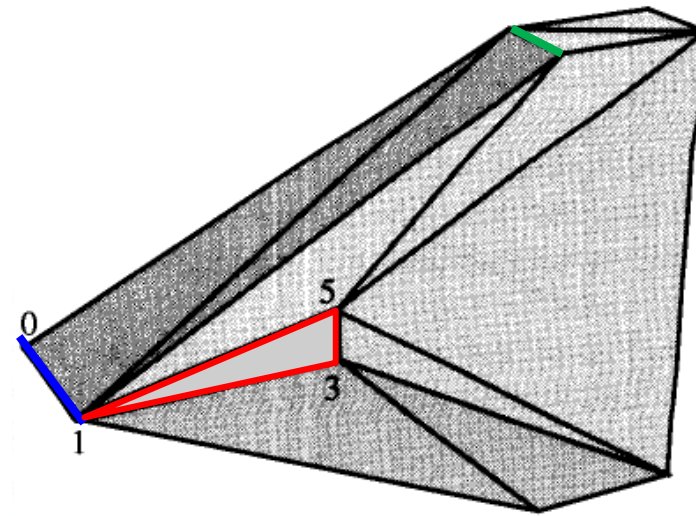
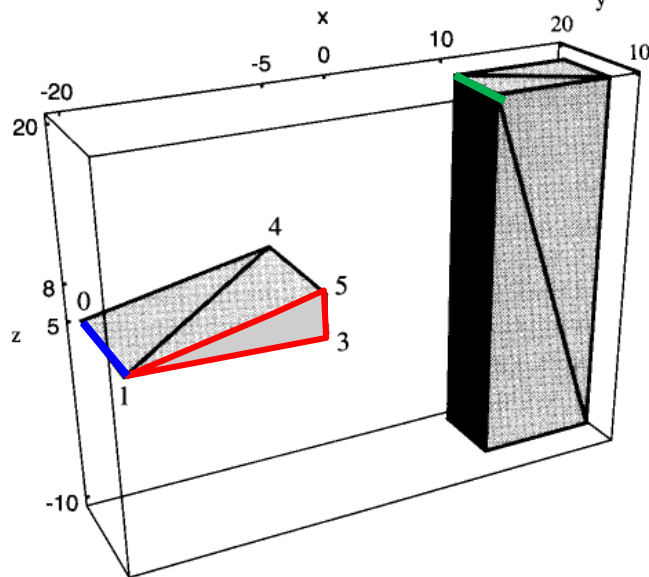
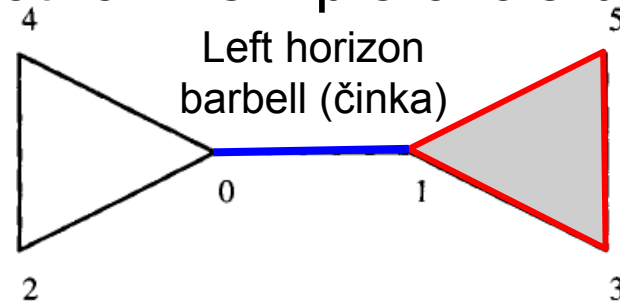

[Berg]

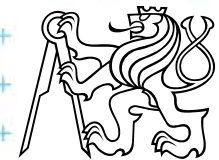

3. Randomized incremental alg. principle

1. Create tetrahedron (smallest CH in 3D) $CH(P_4)$

- Take 2 points p_1 and p_2
- Search the 3rd point not lying on line p_1p_2
- Search the 4th point not lying in plane $p_1p_2p_3$...if not found, use 2D CH

2. Perform random permutation of remaining points $\{p_5, \dots, p_n\}$

3. For p_r in $\{p_5, \dots, p_n\}$ do add point p_r to $CH(P_{r-1})$

Notation: for $r \geq 1$ let $P_r = \{p_1, \dots, p_r\}$ is set of already processed pts

- If p_r lies inside or on the boundary of $CH(P_{r-1})$ then do nothing
- If p_r lies outside of $CH(P_{r-1})$ then
 - find and remove visible faces
 - create new faces (triangles) connecting p_r with lines of horizon

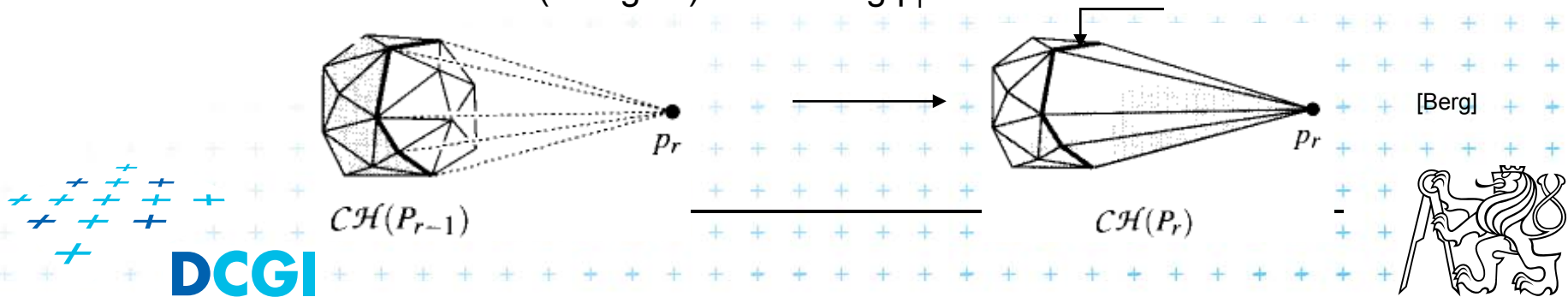

Conflict graph

- Stores unprocessed points with facets of CH they see

- Bipartite graph

points $p_t, t > r$... unprocessed points

facets of $CH(P_r)$... facets of convex hull

conflict arcs ... conflict, as visible facets cannot be in CH

- Maintains sets:

$P_{\text{conflict}}(f)$... points, that see f

$F_{\text{conflict}}(p_r)$... facets visible from p_r
(visible region – deleted after insertion of p_r)

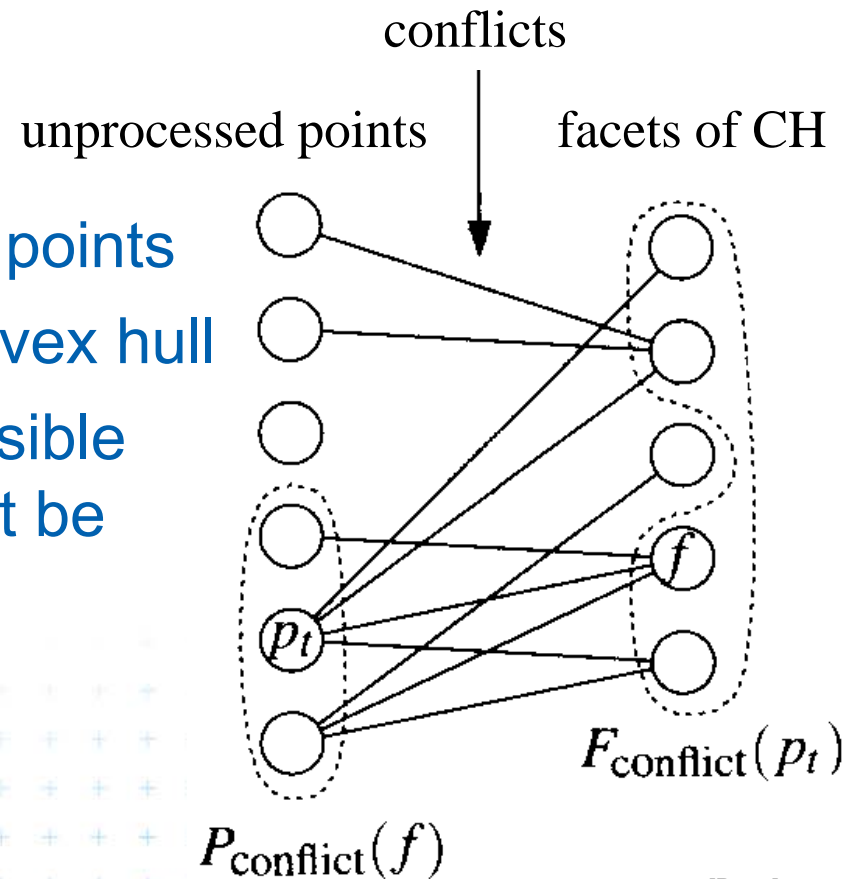

[Berg]

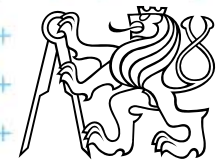

Conflict graph – init and final state

■ Initialization

- Points $\{p_5, \dots, p_n\}$ (not in tetrahedron)
- Facets of the tetrahedron (four)
- Arcs – connect each tetrahedron facet with points visible from it

■ Final state

- Points – $\{\} =$ empty set
- Facets of the convex hull
- Arcs - none

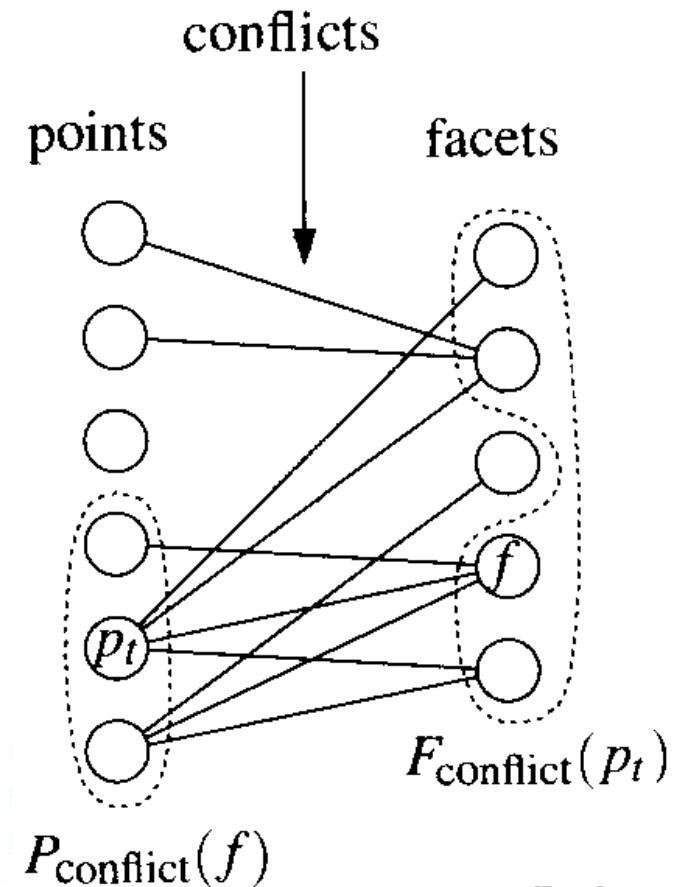

[Berg]

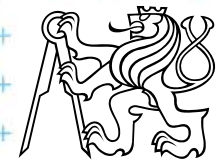

Visibility between point and face

- Face f is **visible** from a point p if that point lies in the open half-space on the other side of h_f than the polytope

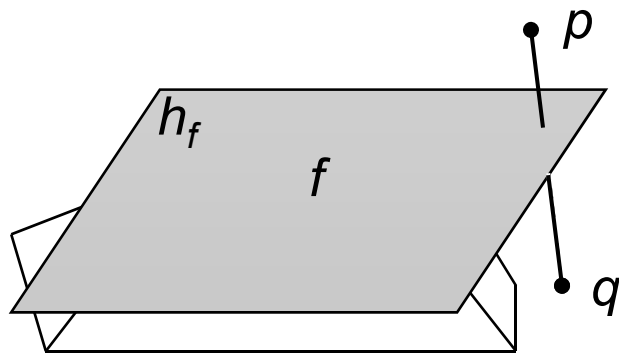

f is **visible** from p (p is above the plane)

f is **not visible** from q

$p \in P_{\text{conflict}}(f)$, p is among the points that see the face f
 $f \in F_{\text{conflict}}(p)$ f is among the faces visible from point p

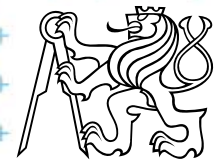

Visibility between point and face

- Face f is **visible** from a point p if that point lies in the open half-space on the other side of h_f than the polytope

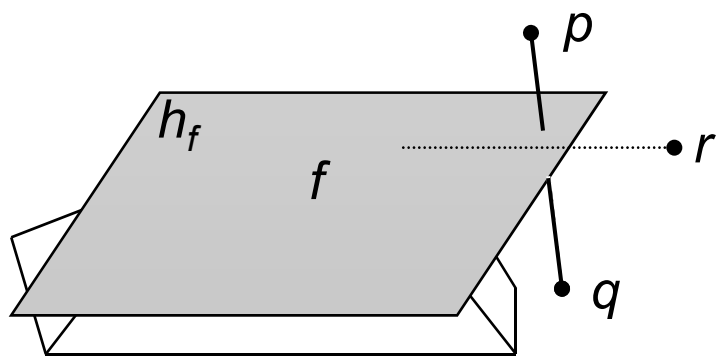

f is **visible** from p (p is above the plane)

f is **not visible** from r lying in the plane of f
(this case will be discussed next)

f is **not visible** from q

$p \in P_{\text{conflict}}(f)$, p is among the points that see the face f
 $f \in F_{\text{conflict}}(p)$ f is among the faces visible from point p



New triangles to horizon

- **Horizon** = edges e incident to visible and invisible facets

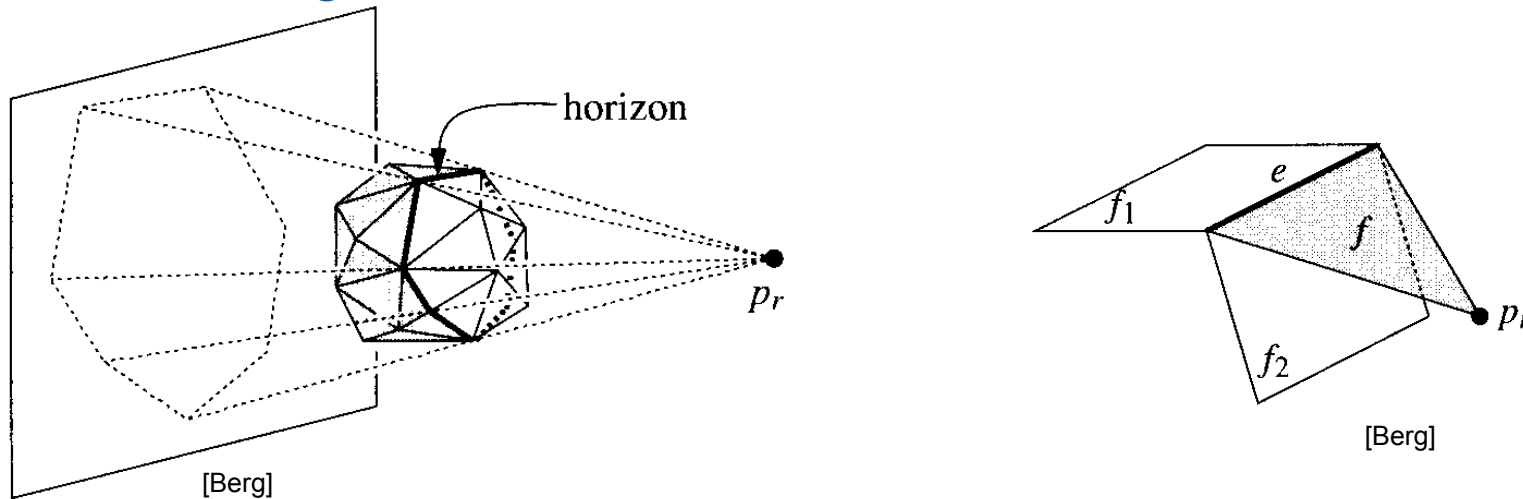

- **New triangle f** connects edge e on horizon and point p_r and
 - creates **new node for facet f** updates the conflict graph
 - add **arcs to points visible from f** (subset from $P_{\text{conflict}}(f_1) \cup P_{\text{conflict}}(f_2)$)
- **Coplanar triangles on the plane ep_r**
 - are merged with new triangle.
 - Conflicts in G are copied from the deleted triangle (same plane)



Overview of new point insertion

Processing of point p_r outside

- Remove facets that p_r sees from the CH (do not delete them from the graph G)
- Find horizon edges (around the hole in CH)
- Create new facets from horizon edges to p_r
 - add them to CH
 - create face nodes f in G for them
- Compute what p_r sees – search only from $P(e) = P_{conflict}(f_1) \cup P_{conflict}(f_2)$
- Delete node p_r and face $F_{conflict}(p_r)$ from G



Incremental Convex hull algorithm

IncrementalConvexHull(P)

Input: Set of n points in general position in 3D space

Output: The convex hull $C = CH(P)$ of P

1. Find four points that form an initial tetrahedron, $C = CH(\{p_1, p_2, p_3, p_4\})$
 2. Compute random permutation $\{p_5, p_6, \dots, p_n\}$ of the remaining points
 3. Initialize the **conflict graph** G with all visible pairs (p_t, f) , where f is facet of C and $p_t, t > 4$, are non-processed points
 4. **for** $r = 5$ to n **do** ...inserting p_r , into C
 5. | **if** $(F_{conflict}(p_r))$ is not empty **then** ... p_r is outside, insert p_r , into C
 6. | Delete all facets $F_{conflict}(p_r)$ from C ... only from hull C , not from G
 7. | Walk around visible region boundary, create **list L of horizon edges**
 8. | **for** all $e \in L$ **do**
 9. | connect e to p_r by a **new triangular facet f**
 10. | **if** f is coplanar with its neighbor facet f' along e
 11. | **then** merge f and f' in C , take conflict list from f'
 12. | **else** ... determine conflicts for new facet f
- ... [continue on the next slide]

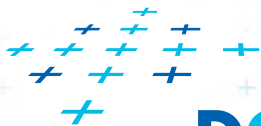

Incremental Convex hull algorithm (cont...)

```
12. | | | else ... not coplanar => determine conflicts for new facet f
13. | | | | Insert f into hull C
14. | | | | Create node for f in G //... new face in conflict graph G
15. | | | | Let f1 and f2 be the facets incident to e in the old CH(Pr-1)
16. | | | | P(e) = Pconflict(f1) ∪ Pconflict(f2)
17. | | | | for all points p ∈ P(e) do
18. | | | | | if f is visible from p, then add(p, f) to G ... new edges in G
19. | | | | Delete the node corresponding to pr and the nodes corresponding
    | | | | to facets in Fconflict(pr) from G, together with their incident arcs
20. return C
```

Complexity: Convex hull of a set of points in E^3 can be computed incrementally in $O(n \log n)$ randomized expected time (process $O(n)$ points, but number of facets and arcs depend on the order of inserting points – up to $O(n^2)$) For proof see: [Berg, Section 11.3]



Convex hull in higher dimensions

- Convex hull in d dimensions can have $\Omega(n^{\lfloor d/2 \rfloor})$
Proved by [Klee, 1980]
- Therefore, 4D hull can have quadratic size
- No $O(n \log n)$ algorithm possible for $d > 3$
- These approaches can extend to $d > 3$
 - Gift wrapping
 - D&C
 - Randomized incremental
 - QuickHull



Conclusion

- Recapitulation of 2D algorithms
- $\geq 3D$ algorithms
 - Gift wrapping
 - D&C
 - Randomized incremental
 - QuickHull



References

- [Berg] Mark de Berg, Otfried Cheong, Marc van Kreveld, Mark Overmars: **Computational Geometry: *Algorithms and Applications***, Springer-Verlag, 3rd rev. ed. 2008. 386 pages, 370 fig. ISBN: 978-3-540-77973-5, Chapter 11, <http://www.cs.uu.nl/geobook/>
- [Boissonnat] J.-D. Boissonnat and M. Yvinec, ***Algorithmic Geometry***, Cambridge University Press, UK, 1998. Chapter 9 – Convex hulls
- [Preparata] Preparata, F.P., Shamos, M.I.: ***Computational Geometry. An Introduction***. Berlin, Springer-Verlag, 1985.
- [Mount] [Mount] Mount, D.: ***Computational Geometry Lecture Notes for Fall 2016***, University of Maryland, Lectures 3, 4 and 24.
<http://www.cs.umd.edu/class/fall2016/cmsc754/Lects/cmsc754-fall16-lects.pdf>
- [Chan] Timothy M. Chan. Optimal output-sensitive convex hull algorithms in two and three dimensions., ***Discrete and Computational Geometry***, 16, 1996, 361-368.
<http://citeseerx.ist.psu.edu/viewdoc/summary?doi=10.1.1.44.389>

