

Medical ultrasound imaging

Introduction

André Sopczak

Institute of Experimental and Applied Physics,
Czech Technical University in Prague
<http://cern.ch/sopczak>
andre.sopczak@cvut.cz
based on lectures 2008-2023 by J.Kybic,
using plots by J.Hornak¹, E.Dove, P.Stoyen

2024

¹<http://www.cis.rit.edu/htbooks/mri/>

Introduction

Ultrasound acoustics

- Waves

- Wave equation

- Reflection and refraction

- Interface reflection

- Attenuation

Medical ultrasound

- Devices

- Cardiologic US

- Intravascular US

Generation/detection

- Generation

- Steering/Beamforming

- Focusing

- Processing and control

- Artefacts

Medical ultrasound basics

- ▶ Acoustic waves, frequency 2 ~ 50 MHz
- ▶ Measure the time and intensity of the echo
- ▶ Harmless
- ▶ Stopped by air and dense tissues (bone)

Ultrasound Principle

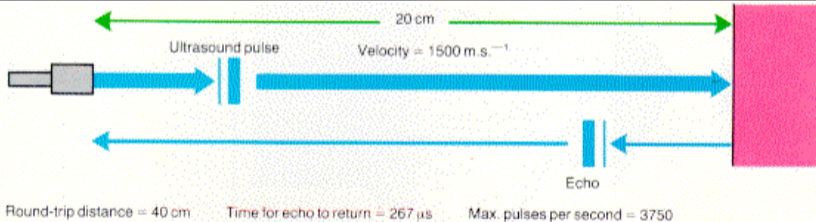

Introduction

Ultrasound acoustics

- Waves

- Wave equation

- Reflection and refraction

- Interface reflection

- Attenuation

Medical ultrasound

- Devices

- Cardiologic US

- Intravascular US

Generation/detection

- Generation

- Steering/Beamforming

- Focusing

- Processing and control

- Artefacts

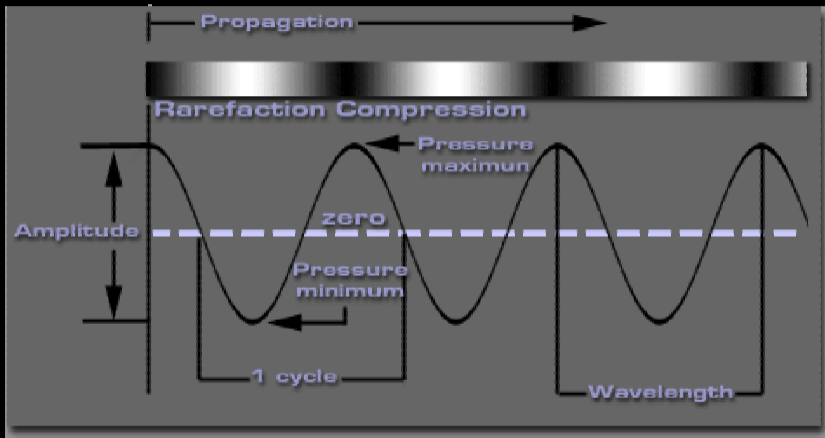

Sinusoidal pressure source

Physical quantities

Ultrasound

Property	Symbol	Unit	Usual values
Speed	c	m/s	1350 ~ 1800 m/s
Wavelength	λ	m	0.1 ~ 0.8 mm
Frequency	f	Hz	2 ~ 20 MHz
Density	ρ	kg/m ³	~ 1000 kg/m ³
Intensity	I	W/m ²	1 ~ 10 mW/cm ²

Introduction

Ultrasound acoustics

Waves

Wave equation

Reflection and refraction

Interface reflection

Attenuation

Medical ultrasound

Devices

Cardiologic US

Intravascular US

Generation/detection

Generation

Steering/Beamforming

Focusing

Processing and control

Artefacts

Elementary volume

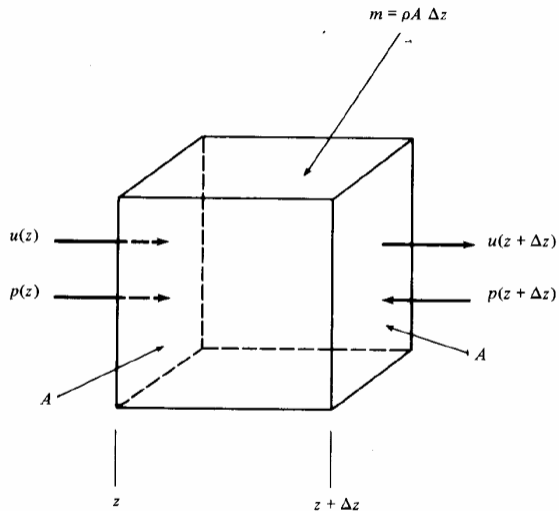

Speed u , pressure p , density ρ , area A , mass m .

Newton's law

Motion along z :

$$F = ma = m \frac{du}{dt} = m \left(\frac{\partial u}{\partial t} + \frac{\partial u}{\partial z} \frac{\partial z}{\partial t} \right) \approx m \frac{\partial u}{\partial t}$$

force $F = pA$:

$$(p(z) - p(z + \Delta z)) A = m \frac{\partial u}{\partial t}$$

for $\Delta z \ll z$:

$$-\frac{\partial p}{\partial z} \Delta z A = m \frac{\partial u}{\partial t}$$

as $m = \rho A \Delta z$

$$-\frac{\partial p}{\partial z} = \rho \frac{\partial u}{\partial t}$$

Conservation of mass law

Difference of entering and exiting mass, density change:

$$A\left(u(z + \Delta z)\rho(z + \Delta z) - u(z)\rho(z)\right) = -A \Delta z \frac{\partial \rho}{\partial t}$$

for $\Delta z \ll z$:

$$\frac{\partial \rho u}{\partial z} = -\frac{\partial \rho}{\partial t}$$

density $\rho = \rho_0 + \rho_1$, $\rho_0 = \text{const}$, $\rho_1 \ll \rho_0$:

$$\rho_0 \frac{\partial u}{\partial z} = -\frac{\partial \rho_1}{\partial t}$$

Compressibility (*stlačiteľnosť*) $\frac{\rho_1}{\rho_0} = Kp$, $K = 1/E$:

$$\frac{\partial u}{\partial z} = -K \frac{\partial p}{\partial t}$$

1D wave equation

$$\rho \frac{\partial u}{\partial t} + \frac{\partial p}{\partial z} = 0 \quad \text{derive by } z$$

$$\frac{\partial u}{\partial z} + K \frac{\partial p}{\partial t} = 0 \quad \text{derive by } t$$

$$\rho \frac{\partial^2 u}{\partial t \partial z} + \frac{\partial^2 p}{\partial z^2} = 0$$

$$\frac{\partial^2 u}{\partial z \partial t} + K \frac{\partial^2 p}{\partial t^2} = 0$$

subtract

$$\frac{\partial^2 p}{\partial z^2} - K \rho \frac{\partial^2 p}{\partial t^2} = 0$$

similarly

$$\frac{\partial^2 u}{\partial z^2} - K \rho \frac{\partial^2 u}{\partial t^2} = 0$$

Wave equation solution

Harmonic wave:

$$p = p_+ \cos(\underbrace{\omega t - kz}_{\phi})$$

where k is the wave number (*vlnové číslo*) [rad/m].

Wave speed (phase velocity):

$$\phi_0 = \omega t - kz \quad \rightarrow \quad z = \frac{\omega}{k}t - \frac{\phi_0}{k}$$

$$c = \omega/k$$

$$c = \lambda f \quad \text{because} \quad \omega = 2\pi f, \quad k = \frac{2\pi}{\lambda}$$

Wave speed

$$p = p_+ \cos(\underbrace{\omega t - kz}_{\phi})$$

$$\frac{\partial^2 p}{\partial z^2} = -p_+ k^2 \cos(\omega t - kz)$$

$$\frac{\partial^2 p}{\partial t^2} = -p_+ \omega^2 \cos(\omega t - kz)$$

The wave equation

$$\frac{\partial^2 p}{\partial z^2} = K\rho \frac{\partial^2 p}{\partial t^2}$$

holds if

$$k^2 = \rho K \omega^2 \quad \rightarrow \quad c = \frac{1}{\sqrt{\rho K}} = \sqrt{\frac{E}{\rho}} \quad \text{because} \quad c = \frac{\omega}{k}$$

Speed of sound

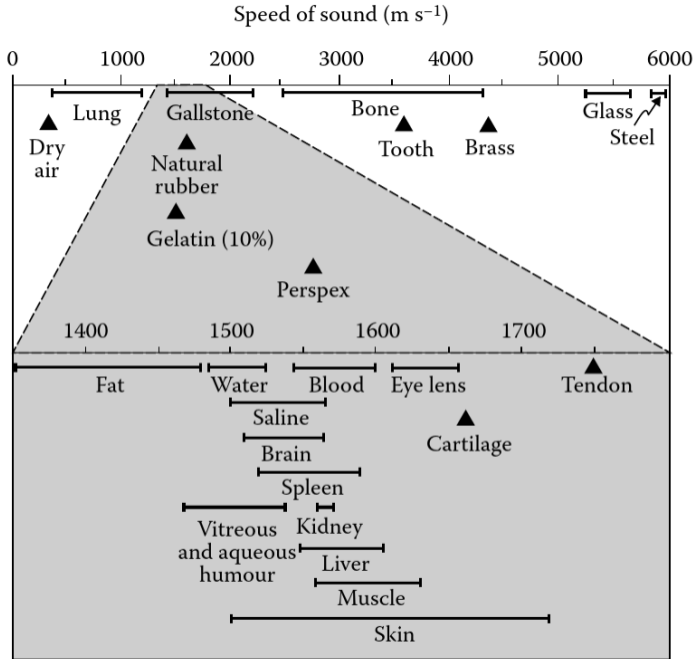

Other wave equation solution

$$p = p_- \cos(\omega t + kz)$$

Any forward or backward wave (by linearity and harmonic decomposition).

$$p = f_+(z + ct) + f_-(z - ct)$$

Forward and backward wave combination:

$$p = p' (\cos(\omega t - kz) + \cos(\omega t + kz))$$

Standing wave:

$$p = 2p' \cos(\omega t) \cos(kz)$$

Acoustic impedance

$$Z_a = \frac{p \text{ (pressure)}}{Q \text{ (flow)}} \text{ [Pa} \cdot \text{s/m}^3\text{]}$$

“acoustic Ohm”.

For an infinite tube (S speed of sound):

$$Z_a = \frac{\rho_0 c}{S}$$

$Z = \rho_0 c$ is a characteristic acoustic impedance.

Unit $[\text{kg/s} \cdot \text{m}^2] = 1 \text{ Rayl}$.

Acoustic impedance (2)

Acoustic impedance

$$Z = \frac{p}{Q}$$

Specific acoustic impedance

$$Z_{\text{sp}} = Z_{\text{a}}S = \frac{p}{Q}S = \frac{p}{u} \quad \text{as flow} \quad Q = Su$$

Characteristic acoustic impedance

$$Z = \rho_0 c = \sqrt{\frac{\rho_0}{K}}$$

For plane waves in lossless medium

$$Z = Z_{\text{sp}}$$

Wave intensity

Kinetic and potential energy density (phase shifted by 90°)

$$i = \frac{1}{2} \left(Zu^2 + \frac{p^2}{Z} \right) \quad [\text{W/m}^2]$$

Effective values

$$I = U^2 Z = \frac{P^2}{Z}$$

Often expressed in dB

$$10 \log_{10} \frac{I_1}{I_2} = 20 \log_{10} \frac{P_1}{P_2} = 20 \log_{10} \frac{U_1}{U_2}$$

Speed and impedance variations

Material	Density ρ (kgm^{-3})	Speed c (ms^{-1})	Characteristic impedance Z ($\text{kgm}^{-2}\text{s}^{-1}$) $\times 10^6$	Absorption coefficient α (dB cm^{-1}) at 1 MHz
Water	1000	1480	1.5	0.0022
Blood	1060	1570	1.62	(0.15)
Bone	1380–1810	4080	3.75–7.38	(14.2–25.2)
Brain	1030	1558	1.55–1.66	(0.75)
Fat	920	1450	1.35	(0.63)
Kidney	1040	1560	1.62	–
Liver	1060	1570	1.64–1.68	(1.2)
Lung	400	650	0.26	(40)
Muscle	1070	1584	1.65–1.74	(0.96–1.4)
Spleen	1060	1566	1.65–1.67	–

Introduction

Ultrasound acoustics

Waves

Wave equation

Reflection and refraction

Interface reflection

Attenuation

Medical ultrasound

Devices

Cardiologic US

Intravascular US

Generation/detection

Generation

Steering/Beamforming

Focusing

Processing and control

Artefacts

Ray/tissue interaction types

- ▶ $d \gg \lambda$
 - ▶ Geometric (specular) reflection and refraction.
 - ▶ Strong reflection.
 - ▶ Diaphragm, vessels, tissue/bone interface, tissue/lung interface, ...
- ▶ $d \ll \lambda$
 - ▶ Scattered reflection. Stochastic non-directional scattering and interference.
 - ▶ Main tissue signal. Speckle.
 - ▶ Most soft tissues, blood.

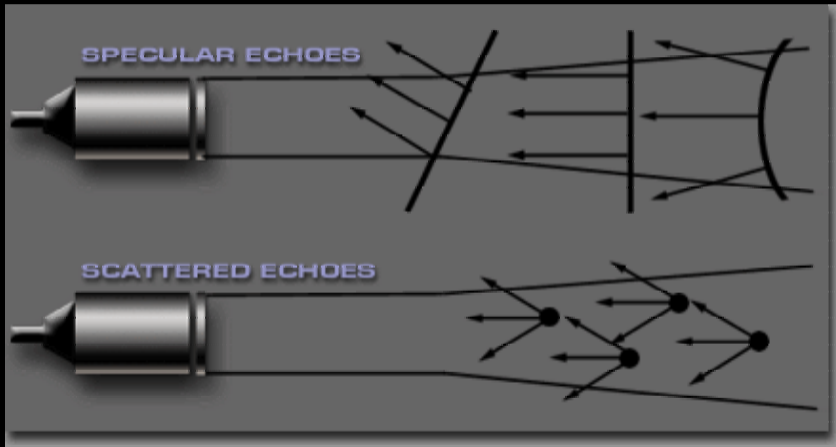

Specular Reflection



- The first, specular echoes, originate from relatively large, strongly reflective, regularly shaped objects with smooth surfaces. These reflections are angle dependent, and are described by reflectivity equation . This type of reflection is called specular reflection.

Scattered Reflection



- The second type of echoes are scattered that originate from small, weakly reflective, irregularly shaped objects, and are less angle-dependent and less intense. The mathematical treatment of non-specular reflection (sometimes called “speckle”) involves the Rayleigh probability density function. This type of reflection, however, sometimes dominates medical images, as you will see in the laboratory demonstrations.

Reflection and refraction

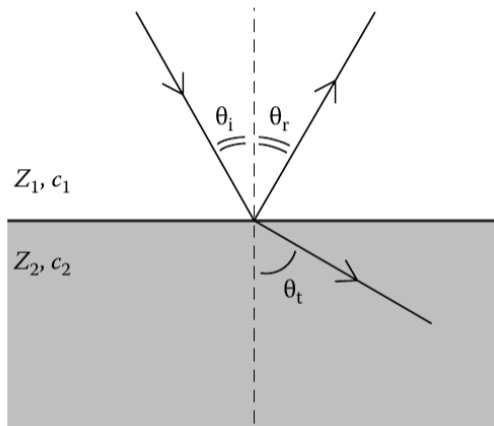

$$\theta_i = \theta_r$$

Snell's law

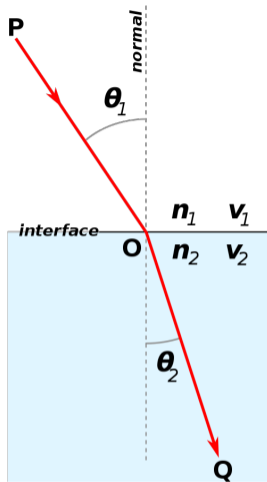

$$\frac{\sin \theta_2}{\sin \theta_1} = \frac{v_2}{v_1} = \frac{c_2}{c_1}$$

Fermat's principle of least time.

Reflectivity

Amplitude reflection coefficient for normal incidence $\theta_i = \theta_r = 0$

$$R_a = \frac{P_r}{P_i} = \frac{U_r}{U_i} = \frac{Z_2 - Z_1}{Z_2 + Z_1}$$

Reflectivity for Various Tissues



<i>Materials at Interface</i>	<i>Reflectivity</i>
Brain-skull bone	0.66
Fat-muscle	0.10
Fat-kidney	0.08
Muscle-blood	0.03
Soft tissue-water	0.05
Soft tissue-air	0.9995

Reflectivity (2)

Power/intensity reflection coefficient

$$R = \frac{I_r}{I_i} = R_a^2 = \left(\frac{Z_2 - Z_1}{Z_2 + Z_1} \right)^2$$

Reflectivity (2)

Power/intensity reflection coefficient

$$R = \frac{I_r}{I_i} = R_a^2 = \left(\frac{Z_2 - Z_1}{Z_2 + Z_1} \right)^2$$

Energy conservation law

$$I_i = I_r + I_t \quad \longrightarrow \quad R = 1 - \frac{I_t}{I_i}$$

Reflectivity (3)

Reflection for arbitrary angle

$$R_a = \frac{Z_2 \cos \theta_i - Z_1 \cos \theta_t}{Z_2 \cos \theta_i + Z_1 \cos \theta_t}$$

Directional dependency of reflection

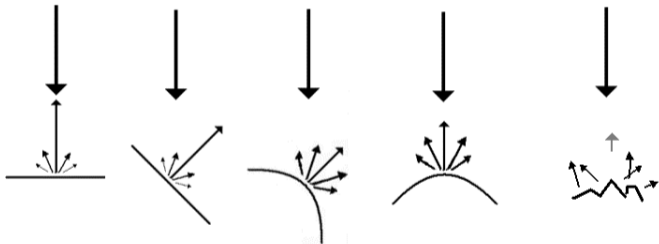

Directional dependency of reflection

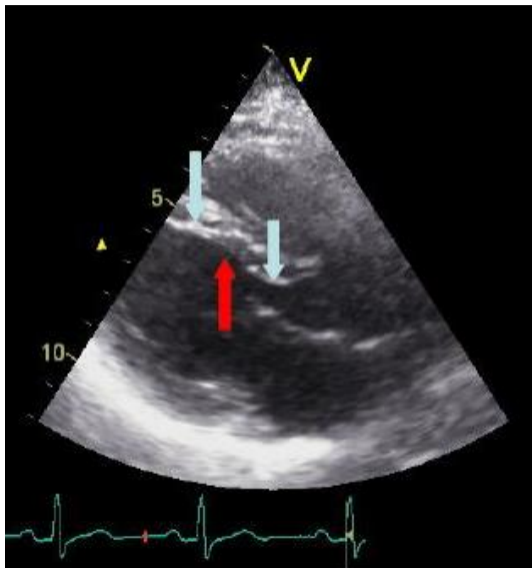

Echoes from Two Interfaces

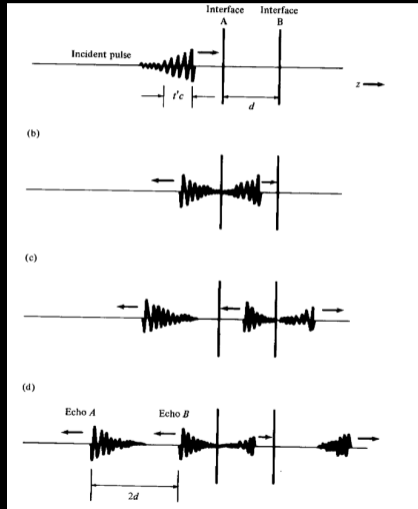

Echoes from Internal Organ

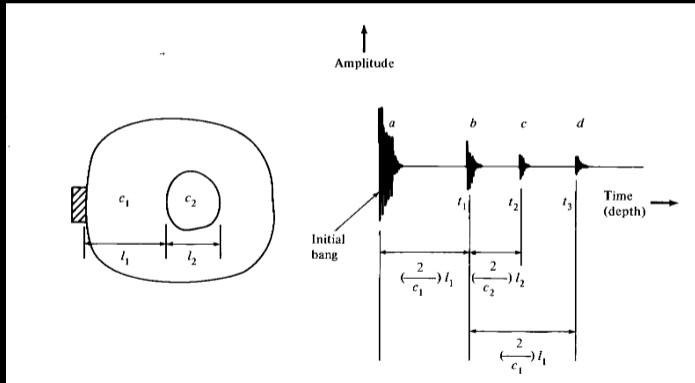

Attenuation

Signal attenuation reasons:

- ▶ Wavefront divergence
- ▶ Scattering (elastic)
- ▶ Absorption (tissue heating)

Attenuation (2)

- ▶ Amplitude attenuation

$$P(x) = P_0 e^{-\mu x}$$

Attenuation (2)

- ▶ Amplitude attenuation

$$P(x) = P_0 e^{-\mu x}$$

- ▶ Power/intensity attenuation

$$I(x) = I_0 e^{-2\mu x}$$

Attenuation (2)

- ▶ Amplitude attenuation
- ▶ Power/intensity attenuation
- ▶ Half-value layer (HVL)

$$P(x) = P_0 e^{-\mu x}$$

$$I(x) = I_0 e^{-2\mu x}$$

$$\frac{\log 2}{\mu}$$

Attenuation (2)

- ▶ Amplitude attenuation

$$P(x) = P_0 e^{-\mu x}$$

- ▶ Power/intensity attenuation

$$I(x) = I_0 e^{-2\mu x}$$

- ▶ Half-value layer (HVL)

$$\frac{\log 2}{\mu}$$

- ▶ Half-power distance (HPD)

$$\frac{\log 2}{2\mu}$$

Attenuation and frequency

Attenuation increases approximately linearly with frequency

$$\mu \propto f$$

Penetration (approximate)

frequency [MHz]	depth [cm]
3.5	10 ~ 20
5.0	5 ~ 10
7.5	2.5 ~ 5
10.0	1 ~ 4

Ultrasound Attenuation



<i>Material</i>	<i>Half-power distance (cm)</i>
Water	380
Blood	15
Soft tissue	5 to 1
except muscle	1 to 0.6
Bone	0.7 to 0.2
Air	0.08
Lung	0.05

Tissue attenuation variations

Material	Density ρ (kgm ⁻³)	Speed c (ms ⁻¹)	Characteristic impedance Z (kgm ⁻² s ⁻¹) $\times 10^6$	Absorption coefficient α (dB cm ⁻¹) at 1 MHz
Water	1000	1480	1.5	0.0022
Blood	1060	1570	1.62	(0.15)
Bone	1380–1810	4080	3.75–7.38	(14.2–25.2)
Brain	1030	1558	1.55–1.66	(0.75)
Fat	920	1450	1.35	(0.63)
Kidney	1040	1560	1.62	–
Liver	1060	1570	1.64–1.68	(1.2)
Lung	400	650	0.26	(40)
Muscle	1070	1584	1.65–1.74	(0.96–1.4)
Spleen	1060	1566	1.65–1.67	–

Half amplitude

$$20 \log_{10} \frac{1}{2} \approx -6 \text{ dB}$$

Half power

$$20 \log_{10} \frac{1}{\sqrt{2}} = 10 \log_{10} \frac{1}{2} \approx -3 \text{ dB}$$

Tissue attenuation variations

Half amplitude

$$20 \log_{10} \frac{1}{2} \approx -6 \text{ dB}$$

Half power

$$20 \log_{10} \frac{1}{\sqrt{2}} = 10 \log_{10} \frac{1}{2} \approx -3 \text{ dB}$$

At $f = 3.5 \text{ MHz}$, $\mu/f = 0.0022 \text{ dB/cm/MHz}$ corresponds to $\text{HPD} = \frac{3 \text{ dB}}{0.0022 \cdot 3.5 \text{ MHz}} \approx 390 \text{ cm}$

Shadows and enhancements

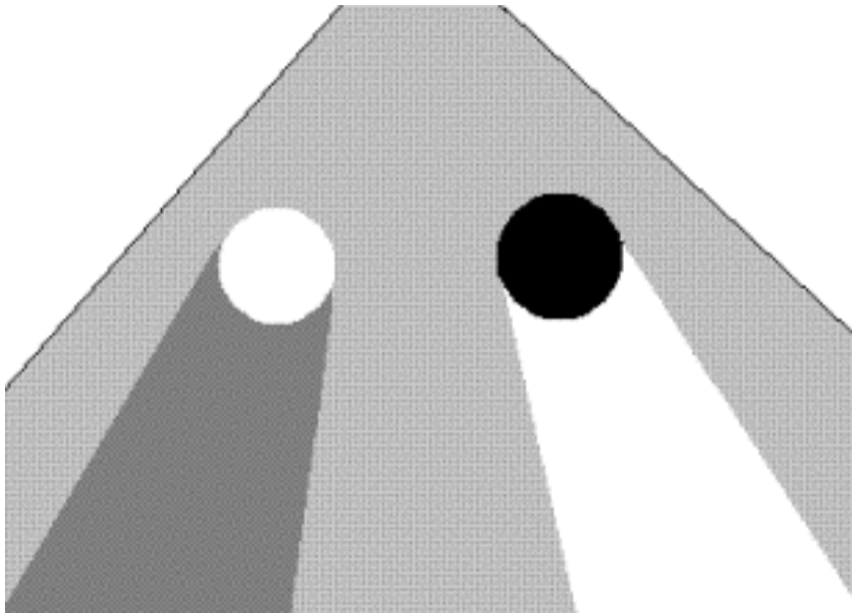

Shadows and enhancements



Introduction

Ultrasound acoustics

Waves

Wave equation

Reflection and refraction

Interface reflection

Attenuation

Medical ultrasound

Devices

Cardiologic US

Intravascular US

Generation/detection

Generation

Steering/Beamforming

Focusing

Processing and control

Artefacts

Medical ultrasound devices



Medical ultrasound devices



Medical ultrasound devices



Medical applications of ultrasound imaging

- ▶ Cardiology (heart)
- ▶ Gynecology: breast, fetus (pregnancy)
- ▶ Internal organs: liver, kidney, thyroid gland
- ▶ Intravascular ultrasound
- ▶ *Therapeutic ultrasound: shock wave (kidney stone), thermal effects (rehabilitation)*

Imaging modes

A osciloscopic, intensity/time

B 2D in the probe plane

C *2D perpendicular*

M/TM 1D+time

Q Doppler (speed)

Imaging modes (2)

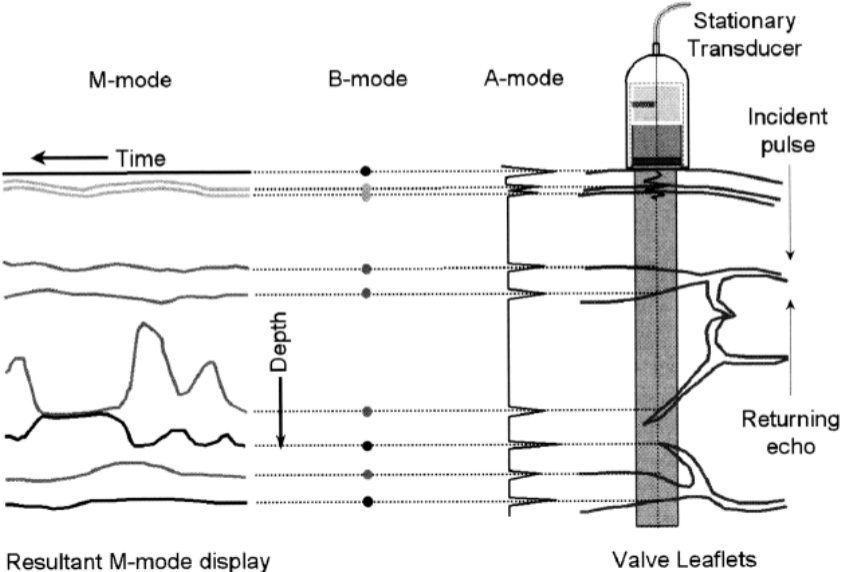

A-mode (Amplitude)

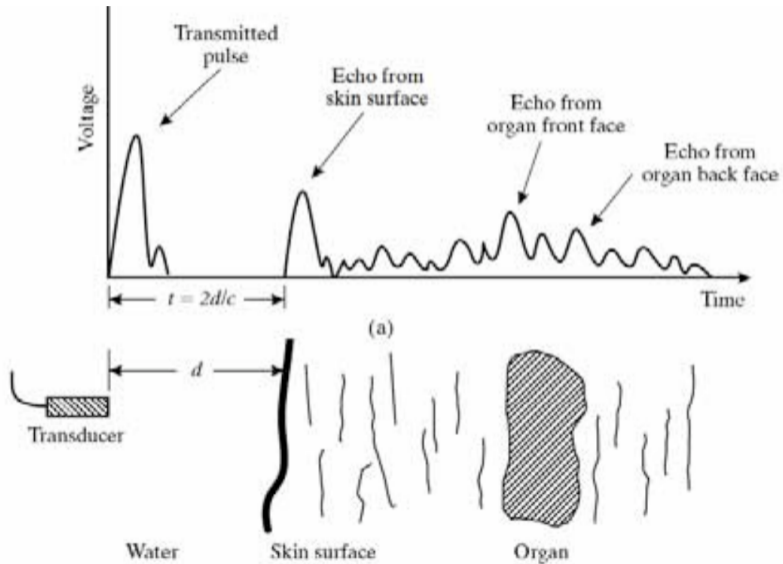

B-mode

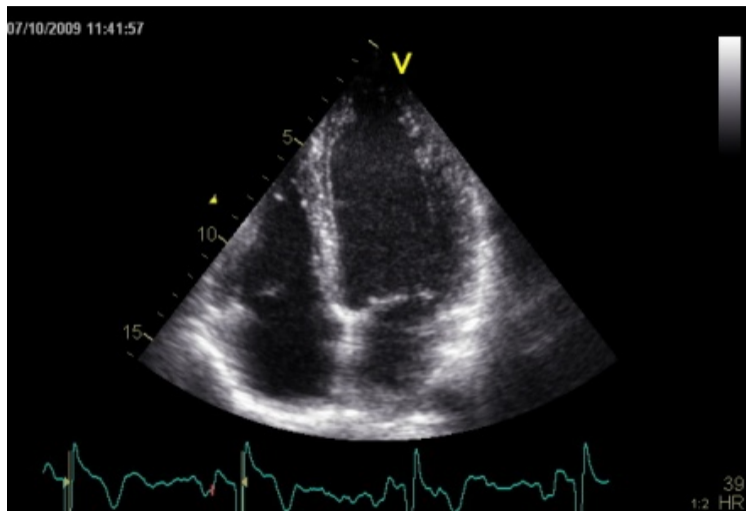

Heart

(T)M-mode

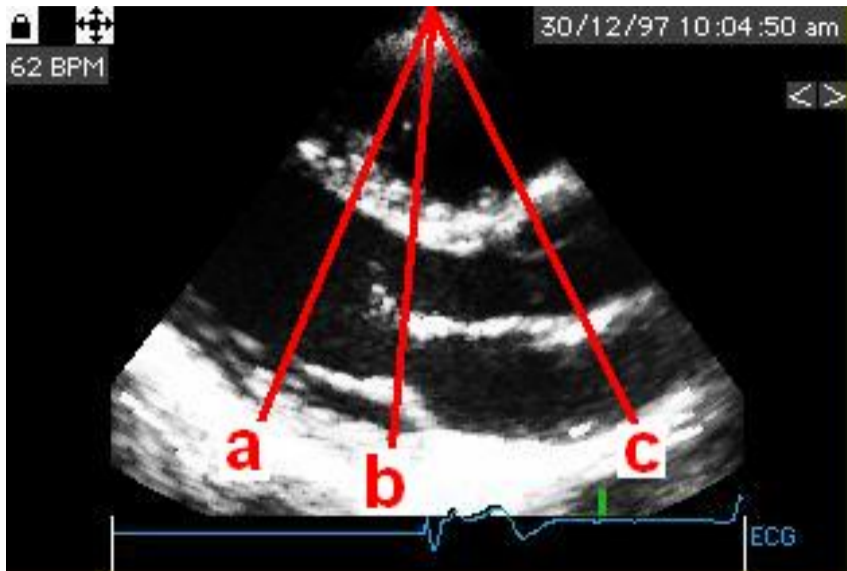

(T)M-mode

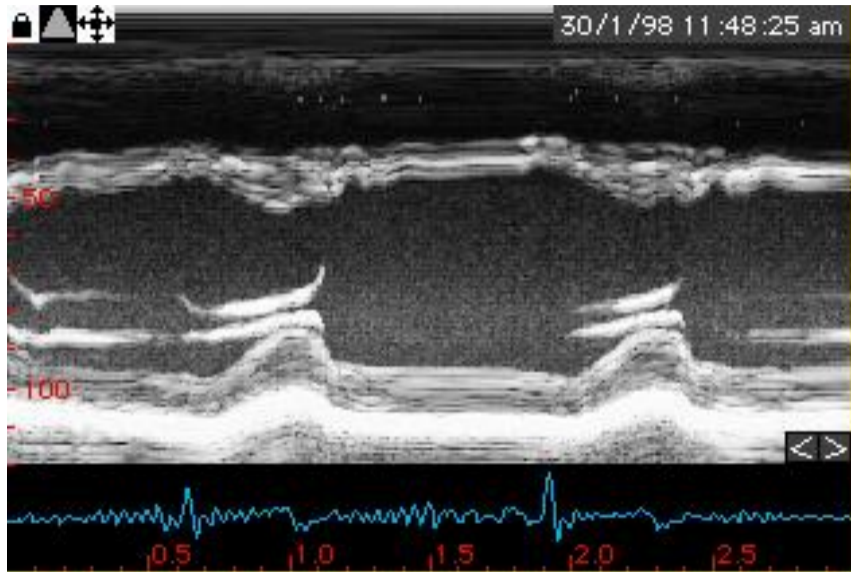

a

(T)M-mode

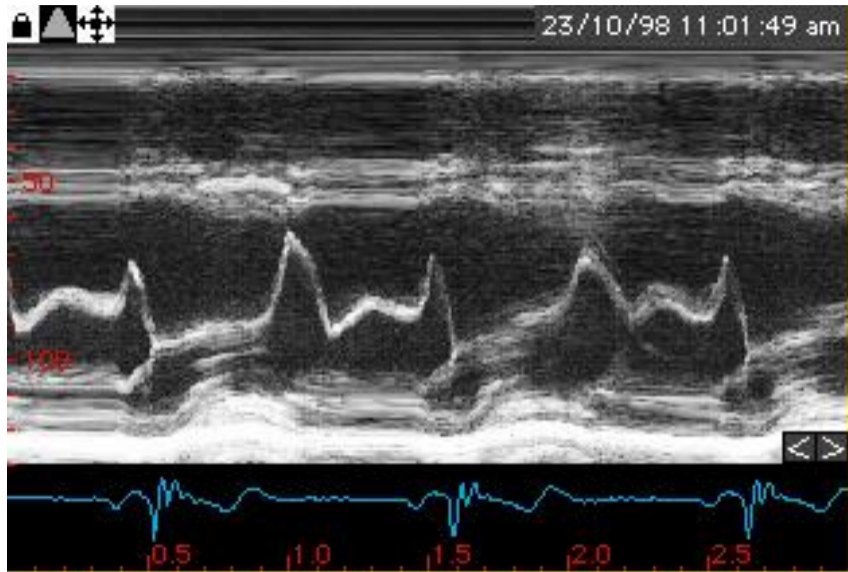

b

(T)M-mode

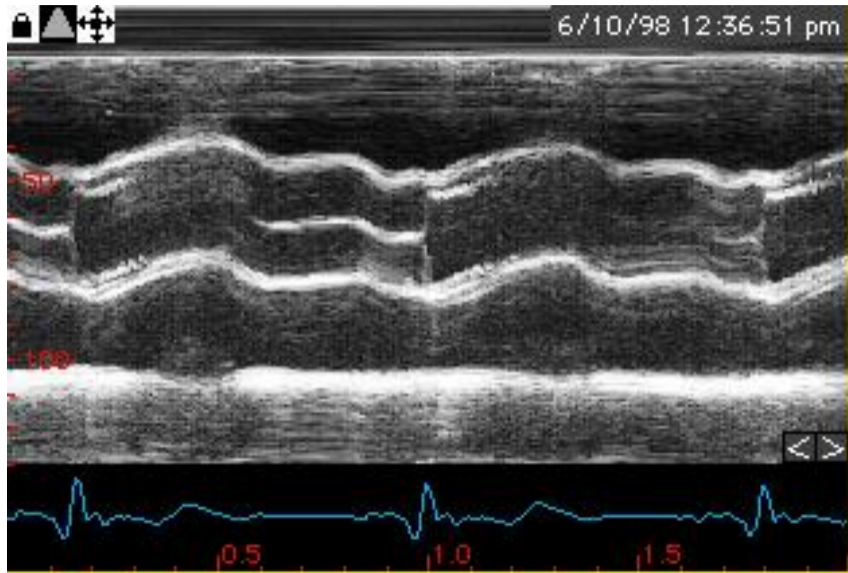

Introduction

Ultrasound acoustics

Waves

Wave equation

Reflection and refraction

Interface reflection

Attenuation

Medical ultrasound

Devices

Cardiologic US

Intravascular US

Generation/detection

Generation

Steering/Beamforming

Focusing

Processing and control

Artefacts

Conventional Cardiac 2D Ultrasound

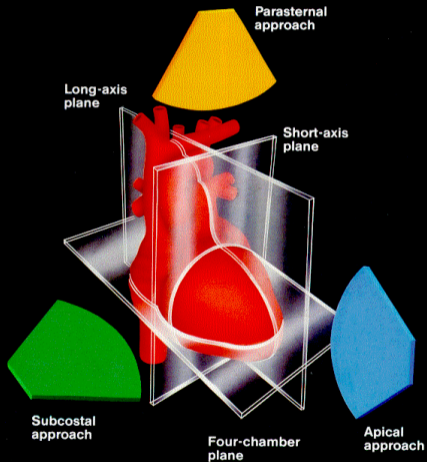

Heart

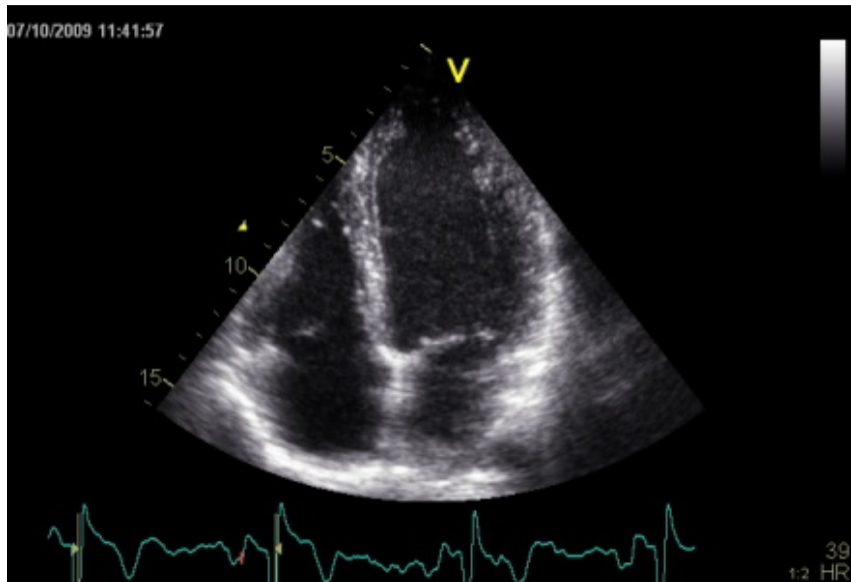

Heart

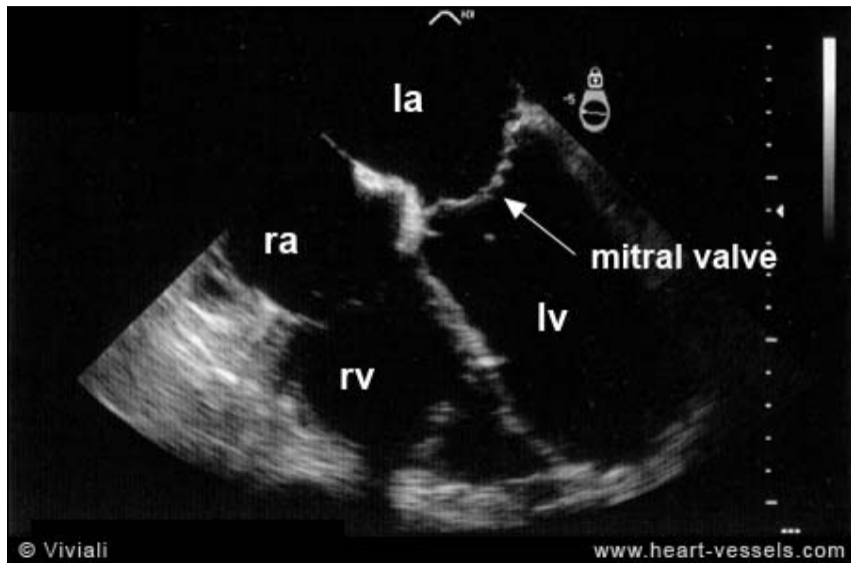

Traditional Ultrasound Images

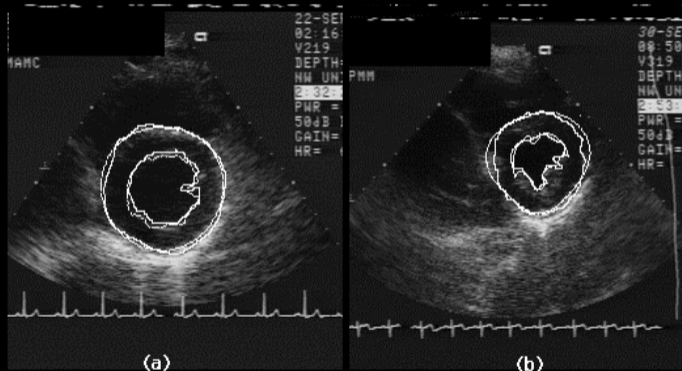

End-diastole

End-systole

TIS:0.7

2.3/2.0-S/M GAIN 74 COMP 70

RUSH PRES. ST. 16CM

LUKES HOSP. PROC 2/0/A/B/A

HP Adult

ID:JS

20 SEP 96

14:19:32

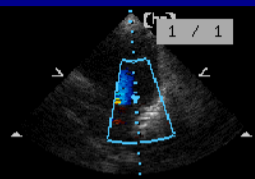

2.5MHZ

56.

56.

56.

56.

56.

56.

56.

56.

56.

56.

56.

56.

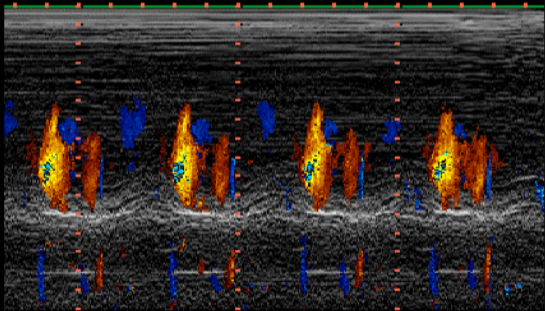

Introduction

Ultrasound acoustics

Waves

Wave equation

Reflection and refraction

Interface reflection

Attenuation

Medical ultrasound

Devices

Cardiologic US

Intravascular US

Generation/detection

Generation

Steering/Beamforming

Focusing

Processing and control

Artefacts

Progression of Vascular Disease

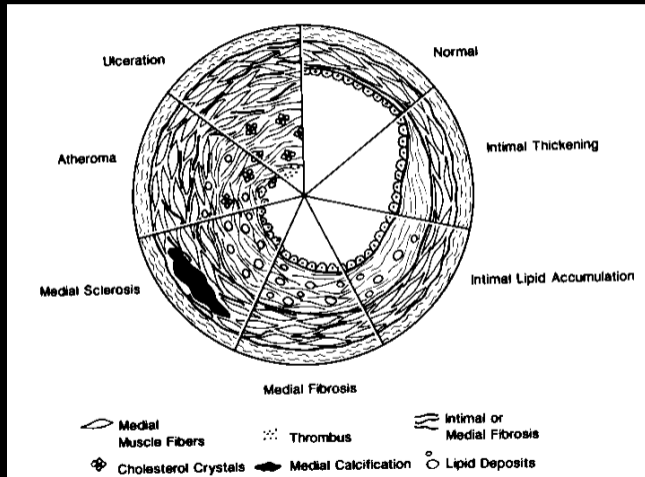

IVUS Catheter

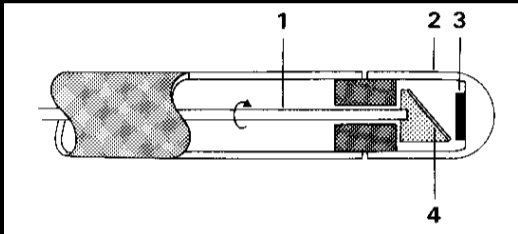

- 1 - Rotating shaft
- 2 - Acoustic window
- 3 - Ultrasound crystal
- 4 - Rotating beveled acoustic mirror

Slightly Diseased Artery in Cross-section

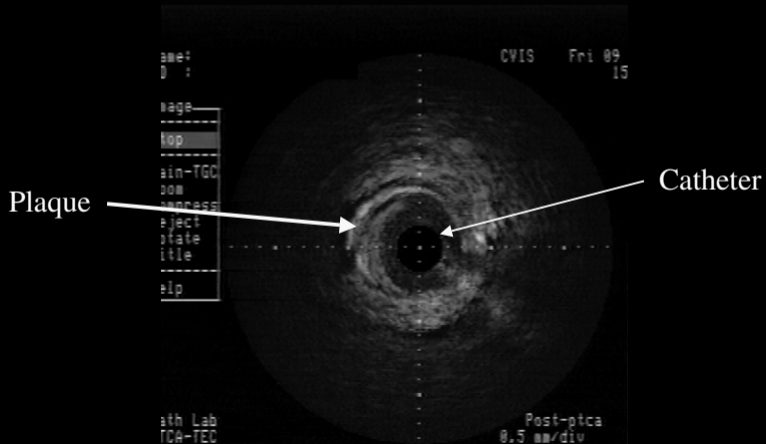

An array of Images

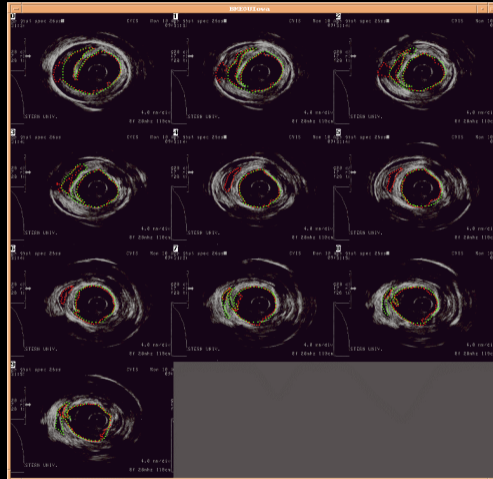

3D IVUS

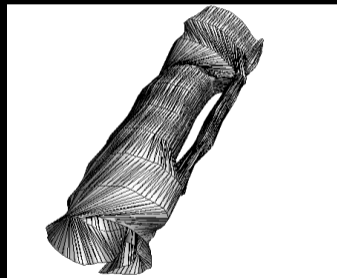
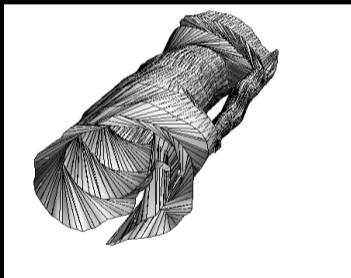

Other ultrasound examples



Other ultrasound examples



Other ultrasound examples



Other ultrasound examples

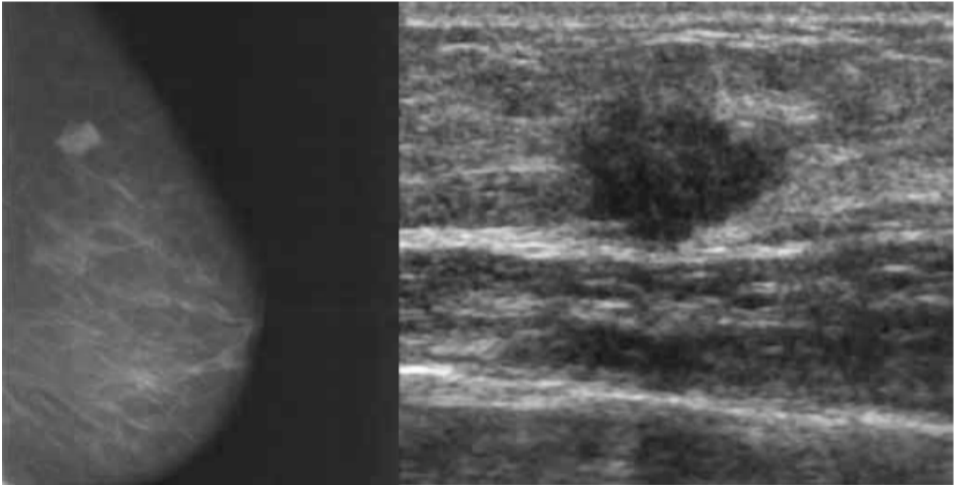

Breast

Introduction

Ultrasound acoustics

Waves

Wave equation

Reflection and refraction

Interface reflection

Attenuation

Medical ultrasound

Devices

Cardiologic US

Intravascular US

Generation/detection

Generation

Steering/Beamforming

Focusing

Processing and control

Artefacts

Pressure Generation



- Piezoelectric crystal
- 'piezo' means pressure, so piezoelectric means
 - pressure generated when electric field is applied
 - electric energy generated when pressure is applied

Charged Piezoelectric Molecules

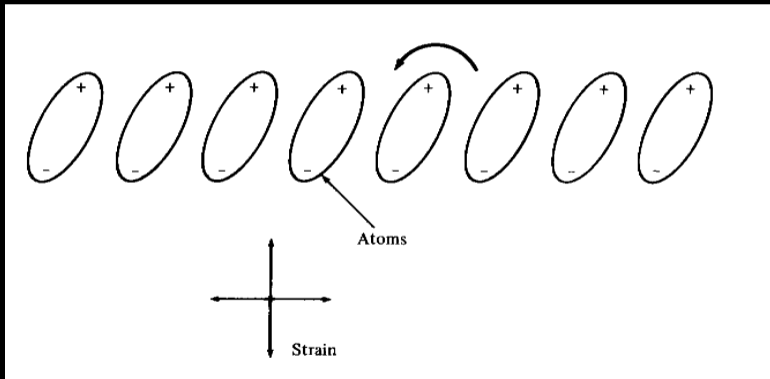

Highly simplified effect of E field

Piezoelectric Effect

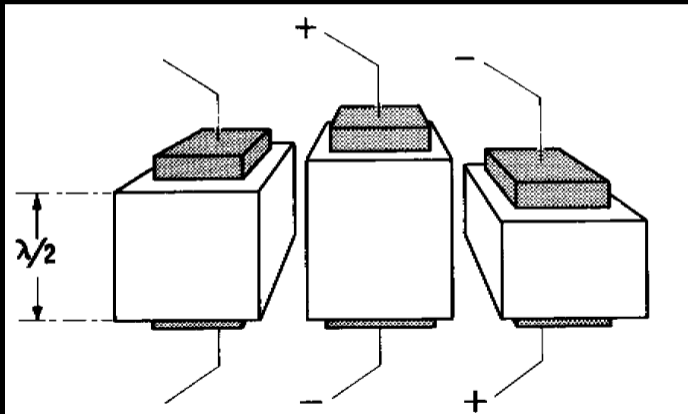

Transducer materials

- ▶ **PZT** — lead zirconate titanate, ceramic
 - ▶ High Z → strong reflection
 - ▶ high resonance quality Q — frequency selective, high sensitivity
- ▶ **PVDF** — polyvinylidene difluoride, plastic
 - ▶ Low Z → low reflection
 - ▶ low resonance quality Q — wider bandwidth, lower sensitivity
- ▶ Composite materials
- ▶ Capacitive transducers

Transducer

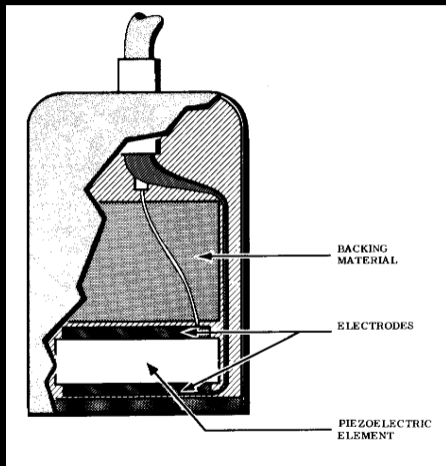

Impedance matching layer

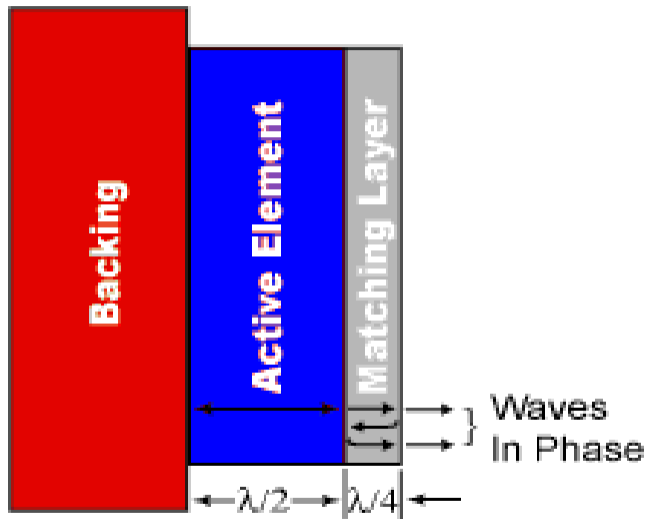

Pressure Radiated by Sharp Pulse

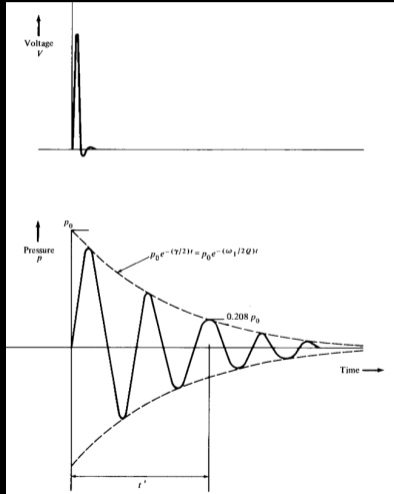

Beam pattern

Plane/unfocused source

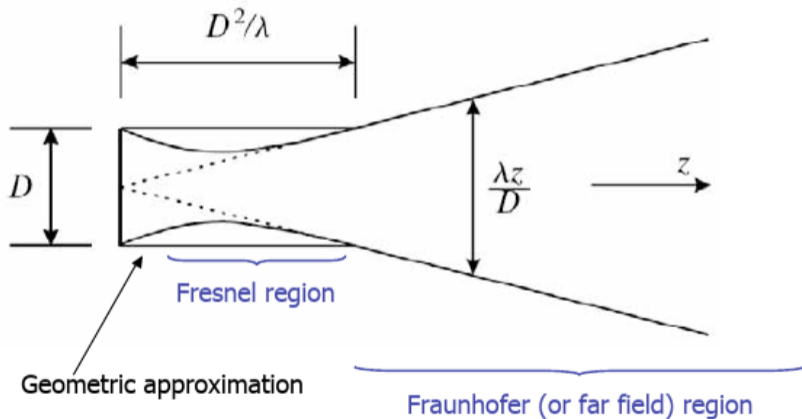

Beam pattern

Plane/unfocused source

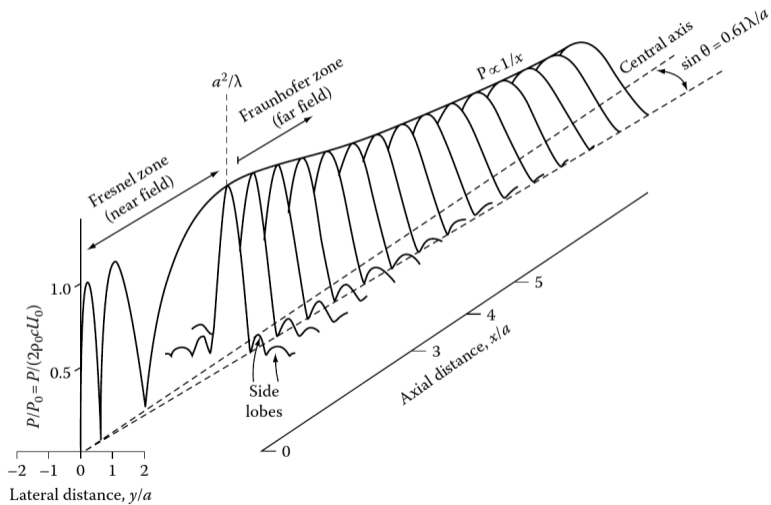

Focused beam pattern

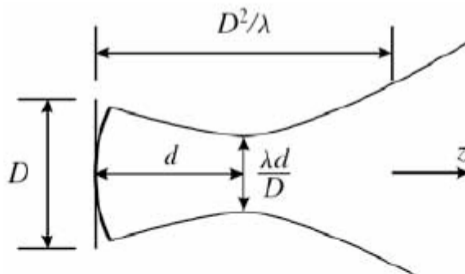
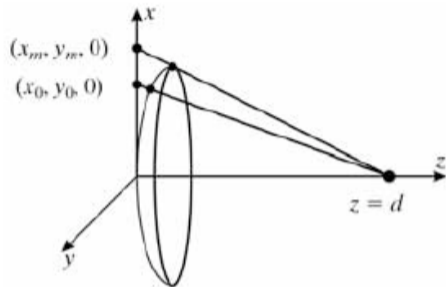

Focused beam pattern

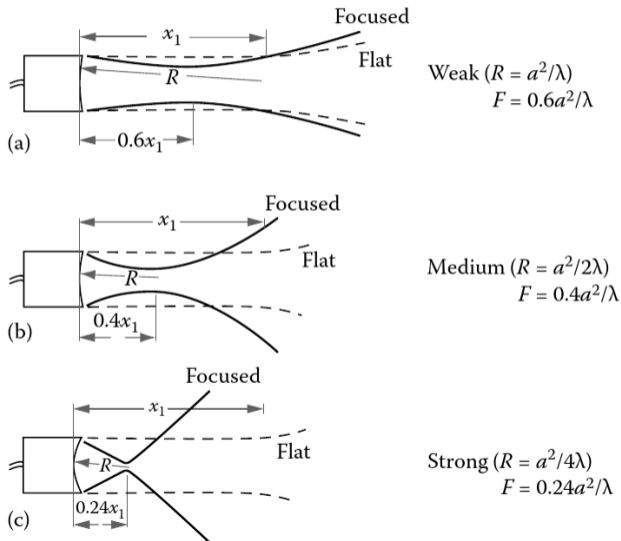

Focused beam pattern

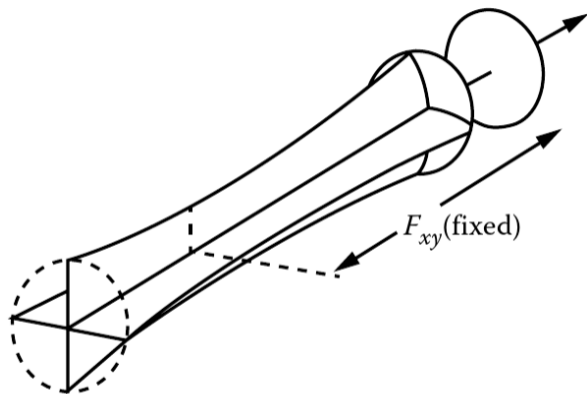

3D profile. Axial, transversal and lateral resolution

Lobes

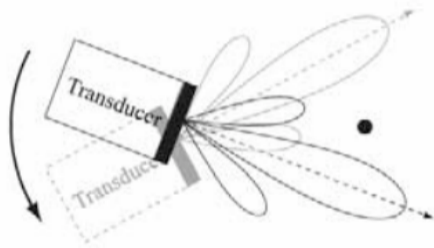

Lobes

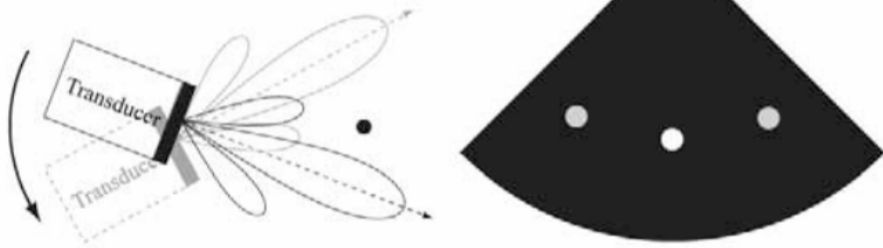

Main lobe — contains 84 % energy, angle

$$\sin \theta \approx \frac{1.22\lambda}{D}$$

Lobes

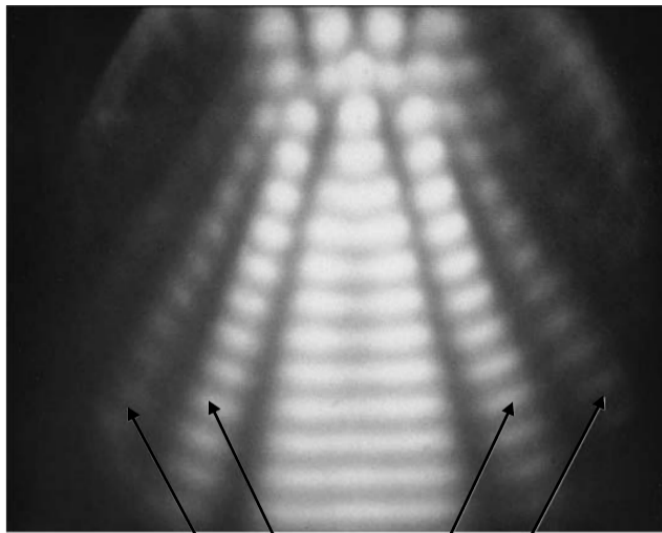

Side lobes

Introduction

Ultrasound acoustics

Waves

Wave equation

Reflection and refraction

Interface reflection

Attenuation

Medical ultrasound

Devices

Cardiologic US

Intravascular US

Generation/detection

Generation

Steering/Beamforming

Focusing

Processing and control

Artefacts

Beam steering

- ▶ Mechanical
- ▶ Electrical

UZV sonda s mech. rozkladem - Siemens

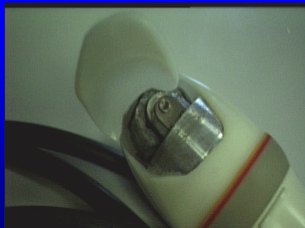
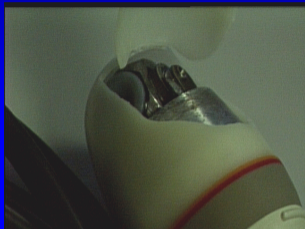

UZV sonda s mech. rozkladem - Siemens

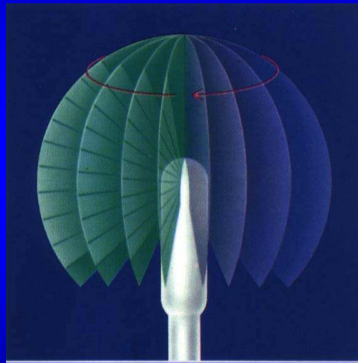
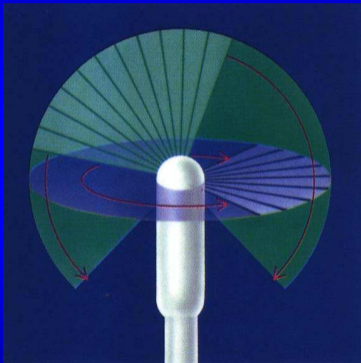

Electronic beam steering

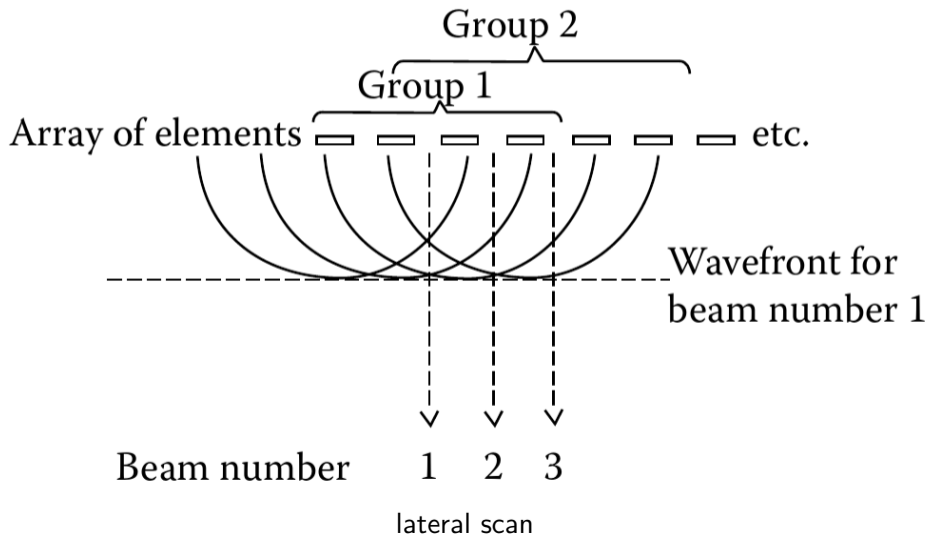

Electronic beam steering

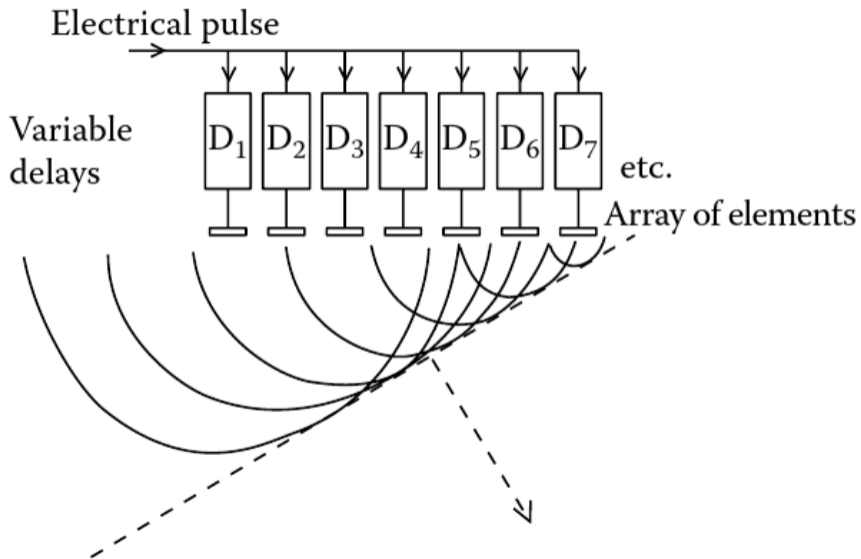

Introduction

Ultrasound acoustics

Waves

Wave equation

Reflection and refraction

Interface reflection

Attenuation

Medical ultrasound

Devices

Cardiologic US

Intravascular US

Generation/detection

Generation

Steering/Beamforming

Focusing

Processing and control

Artefacts

Focusing types

- ▶ Ultrasound lens
- ▶ Electronic

Electronic beam focusing

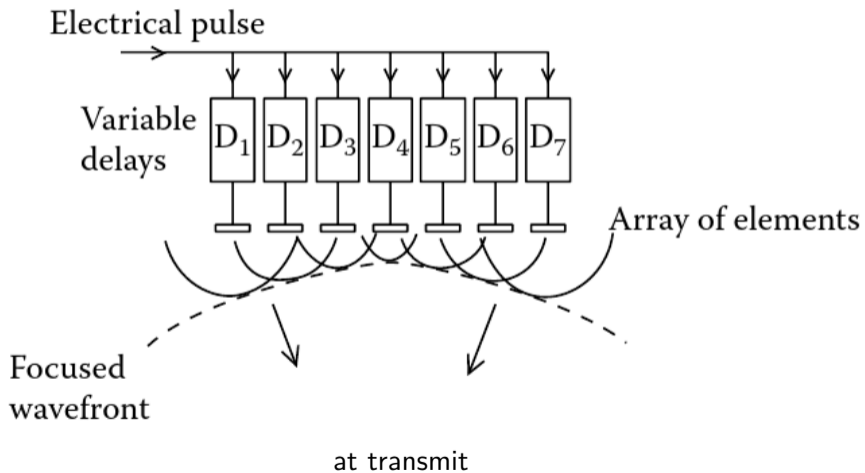

Electronic beam focusing

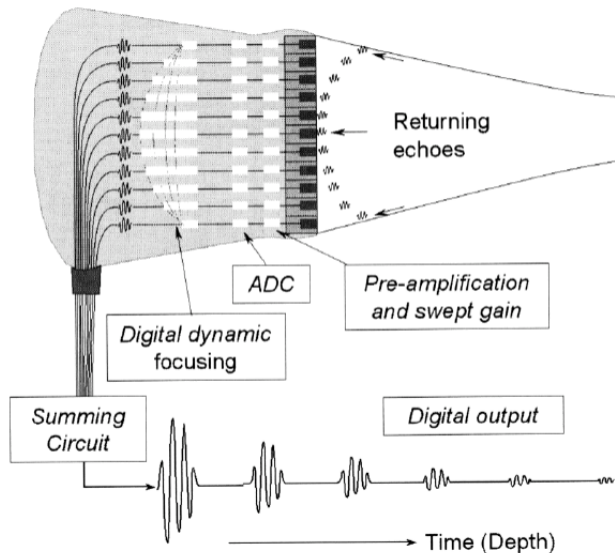

Transducer array configurations

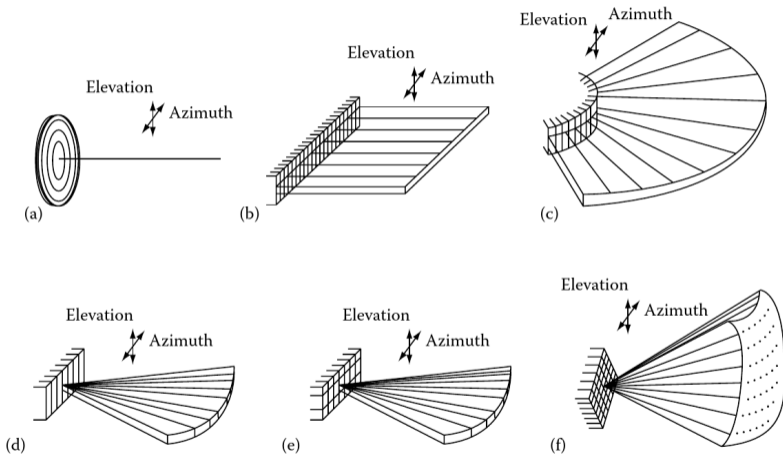

annular, linear, sector, phased-array, 1.5D phased array, 2D phased array

Introduction

Ultrasound acoustics

Waves

Wave equation

Reflection and refraction

Interface reflection

Attenuation

Medical ultrasound

Devices

Cardiologic US

Intravascular US

Generation/detection

Generation

Steering/Beamforming

Focusing

Processing and control

Artefacts

Scanner block diagram

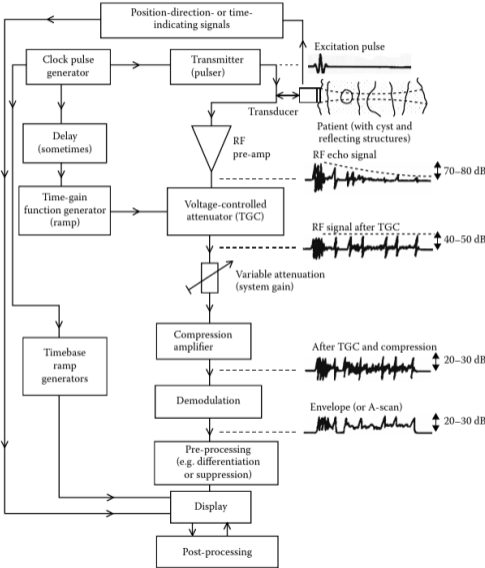

RF processing

- ▶ Time gain control

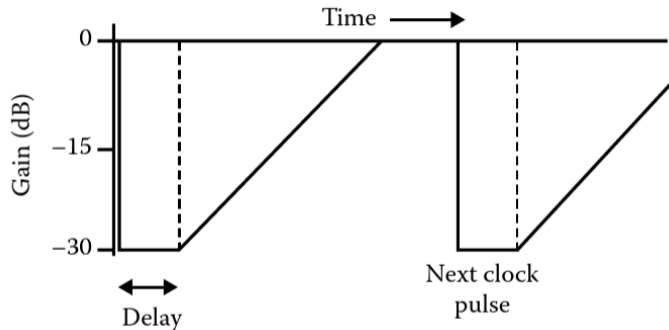

RF processing

- ▶ Time gain control

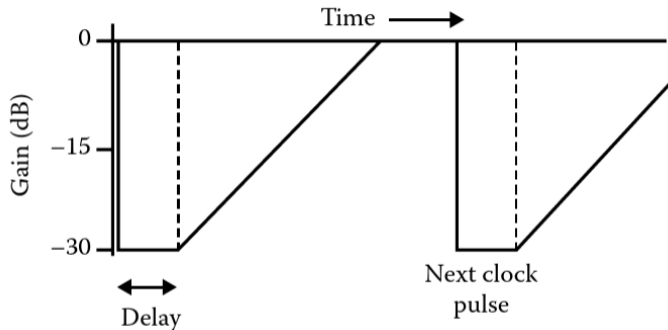

- ▶ Demodulation — RF to envelope, (quadrature) detector

RF processing

- ▶ Time gain control

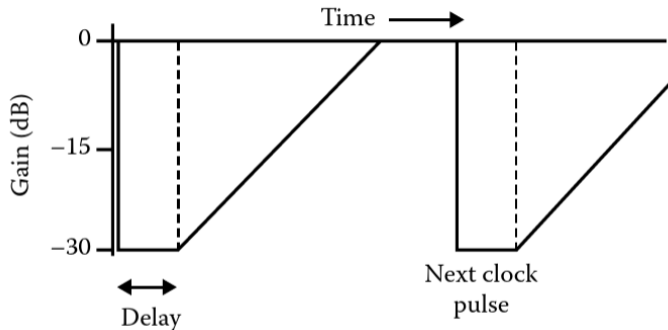

- ▶ Demodulation — RF to envelope, (quadrature) detector
- ▶ Compression amplifier (50 dB range to 20 ~ 30 dB range)

RF processing

- ▶ Time gain control

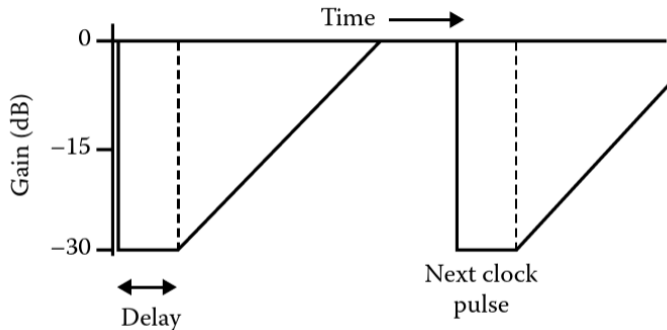

- ▶ Demodulation — RF to envelope, (quadrature) detector
- ▶ Compression amplifier (50 dB range to 20 ~ 30 dB range)
- ▶ Geometry conversion (interpolation)

Scanner block diagram

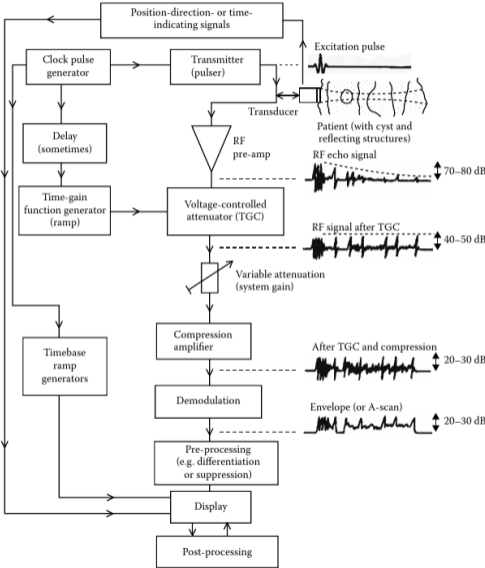

Introduction

Ultrasound acoustics

Waves

Wave equation

Reflection and refraction

Interface reflection

Attenuation

Medical ultrasound

Devices

Cardiologic US

Intravascular US

Generation/detection

Generation

Steering/Beamforming

Focusing

Processing and control

Artefacts

Artefacts

Due to

- ▶ Ultrasound speed variability (change of the speed of the wave, the composition of the tissues)
- ▶ Reflection (multiple reflection)
- ▶ Finite beam width
- ▶ Movement (movement of the tissue structures)

Geometrická distorze UZV zobrazení

- změnou rychlosti šíření UZV vlny,

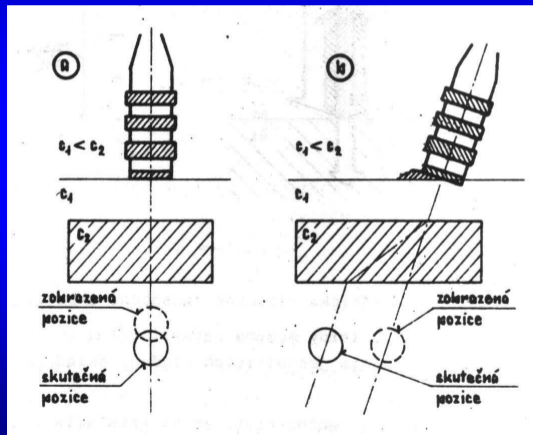

Geometrická distorze UZV zobrazení

- skladbou tkání,

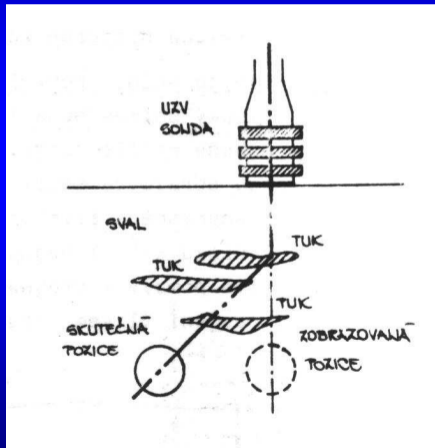

Geometrická distorze UZV zobrazení

- násobnou reflexí,

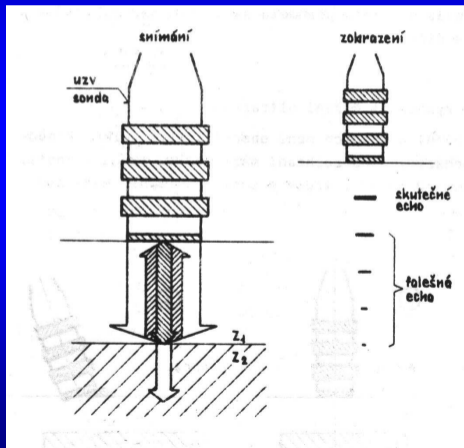

Geometrická distorze UZV zobrazení

- vlivem konečné šířky UZV svazku,

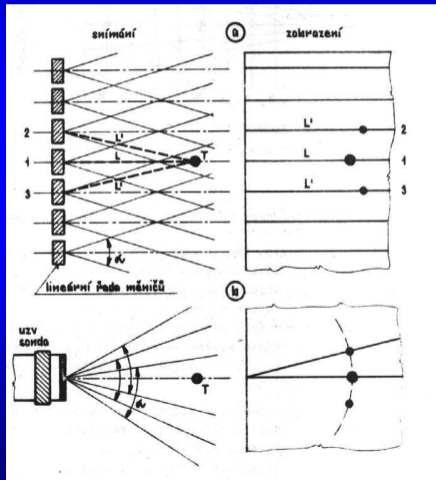

Geometrická distorze UZV zobrazení

- pohybem tkáňových struktur,

