

# Problem solving by search

## Finding the optimal sequence of states/decisions/actions

Tomáš Svoboda, Petr Pošík

Vision for Robots and Autonomous Systems, Center for Machine Perception  
Department of Cybernetics  
Faculty of Electrical Engineering, Czech Technical University in Prague

February 26, 2024

# Problems to solve

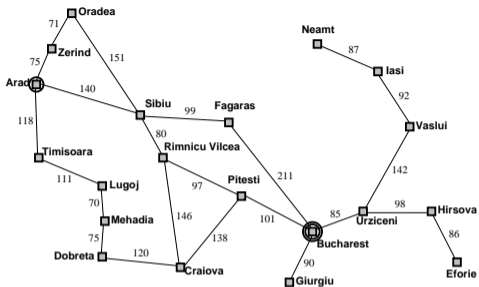

12	1	2	15
11	6	5	8
7	10	9	4
	13	14	3

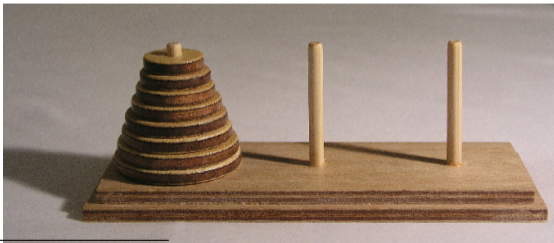
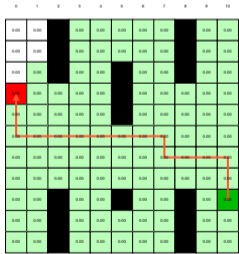

<sup>1</sup>CC BY-SA 3.0, <https://commons.wikimedia.org/w/index.php?curid=228623>

Understanding the problem is the key, DALL-E.

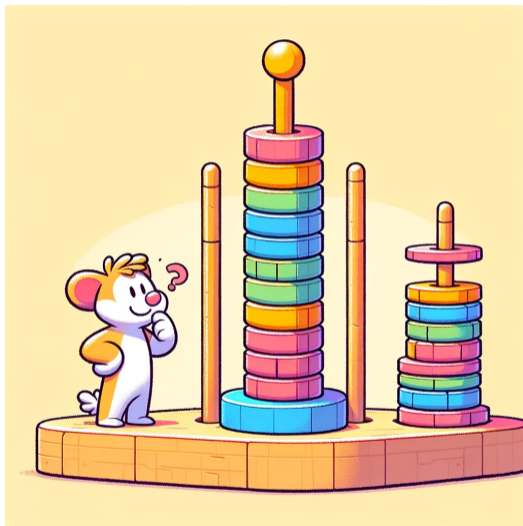

# Outline

- ▶ Search problem. *What do you want to solve?*
- ▶ State space graphs. *How do you formalize/represent the problem? Problem abstraction.*
- ▶ Search trees. *Visualization of the algorithm run.*
- ▶ Strategies: which tree branches to choose?
- ▶ Strategy/Algorithm properties. *Memory, time, ...*
- ▶ Programming infrastructure.

## Example: Traveling in Romania

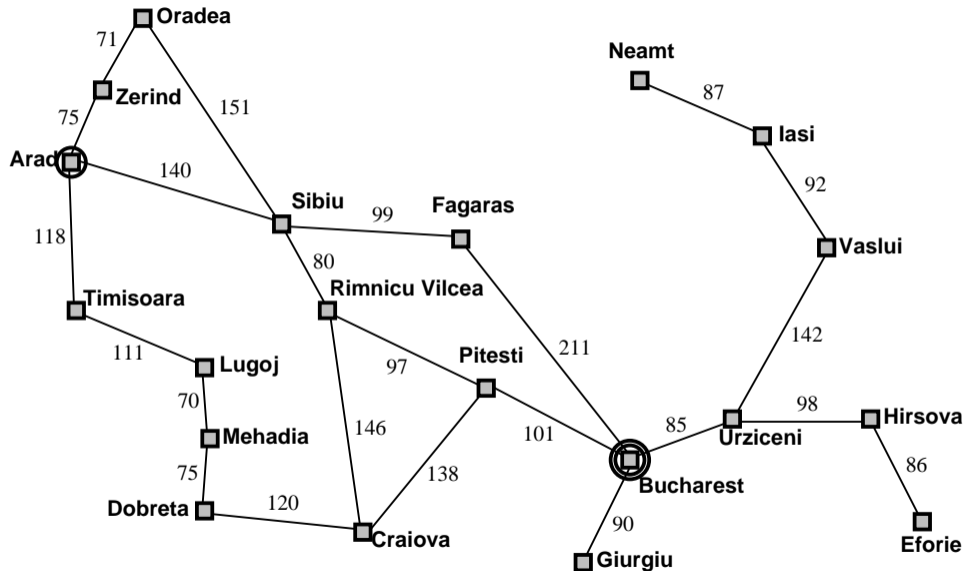

# Traveling Example: State and Actions

Goal:

be in Bucharest

Problem formulation:

states: position in a city (cities)

actions (decisions): select a road

Solution:

Sequence of cities (path)

(sequence of actions/decisions [2])

Optimality – Cost, Loss, Utility, ...:

Energy, time, tolls, ...

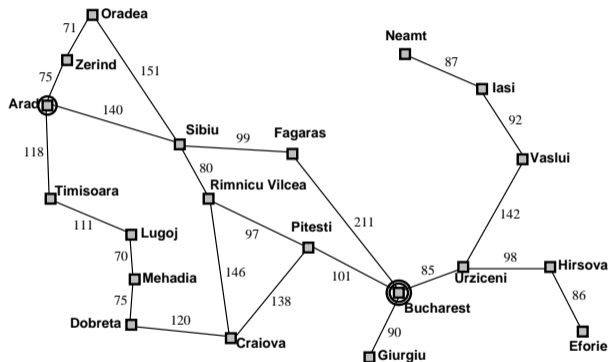

# Traveling Example: State and Actions

Goal:

be in Bucharest

Problem formulation:

states: position in a city (cities)

actions (decisions): select a road

Solution:

Sequence of cities (path)

(sequence of actions/decisions [2])

Optimality – Cost, Loss, Utility, ...:

Energy, time, tolls, ...

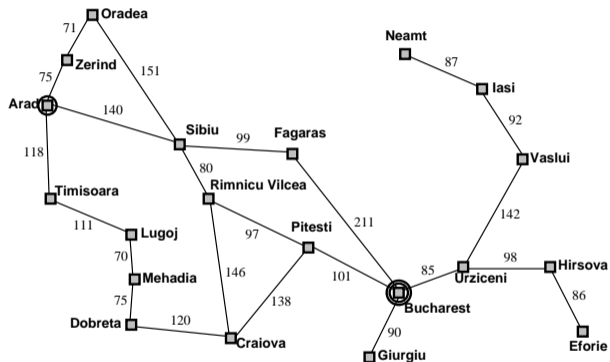

# Traveling Example: State and Actions

Goal:

be in Bucharest

Problem formulation:

states: position in a city (cities)

actions (decisions): select a road

Solution:

Sequence of cities (path)

(sequence of actions/decisions [2])

Optimality – Cost, Loss, Utility, ...:

Energy, time, tolls, ...

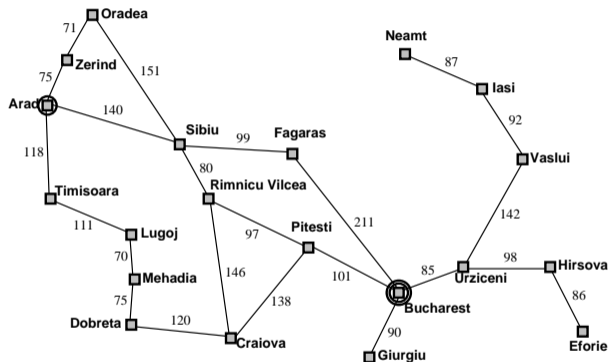



# Traveling Example: State and Actions

Goal:

be in Bucharest

Problem formulation:

states: position in a city (cities)

actions (decisions): select a road

Solution:

Sequence of cities (path)

(sequence of actions/decisions [2])

Optimality – Cost, Loss, Utility, ...:

Energy, time, tolls, ...

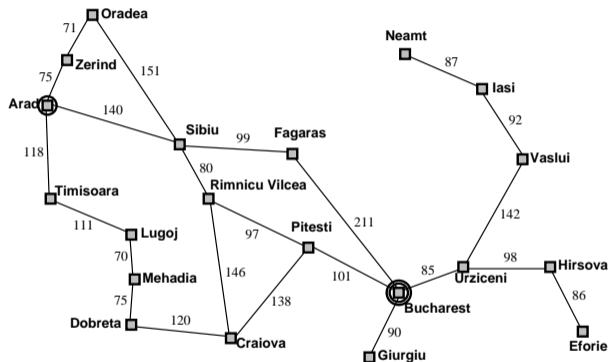

# Traveling Example: State and Actions

Goal:

be in Bucharest

Problem formulation:

states: position in a city (cities)

actions (decisions): select a road

Solution:

Sequence of cities (path)

(sequence of actions/decisions [2])

Optimality – Cost, Loss, Utility, ...:

Energy, time, tolls, ...

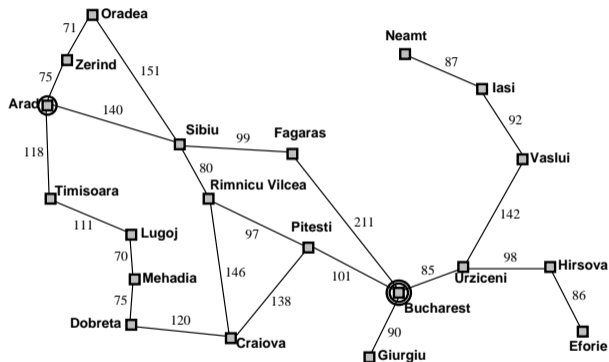

# Traveling Example: State and Actions

Goal:

be in Bucharest

Problem formulation:

states: position in a city (cities)

actions (decisions): select a road

Solution:

Sequence of cities (path)

(sequence of actions/decisions [2])

Optimality – Cost, Loss, Utility, ...:

Energy, time, tolls, ...

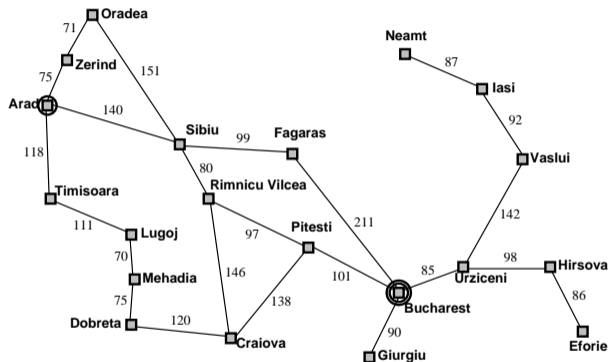

## Example: The 8-puzzle

7	2	4
5		6
8	3	1

Start State

1	2	3
4	5	6
7	8	

Goal State

states?  
actions?  
solution?  
cost?

# A Search Problem

- ▶ **State space** (including Start/Initial state): position, board configuration,
- ▶ Actions : drive to, Up, Down, Left ...
- ▶ Transition model : Given state and action result state (and cost or reward)
- ▶ Goal test : Are we done?

# A Search Problem

- ▶ **State space** (including Start/Initial state): position, board configuration,
- ▶ **Actions** : drive to, Up, Down, Left ...
- ▶ Transition model : Given state and action result state (and cost or reward)
- ▶ Goal test : Are we done?

# A Search Problem

- ▶ **State space** (including Start/Initial state): position, board configuration,
- ▶ **Actions** : drive to, Up, Down, Left ...
- ▶ **Transition model** : Given state and action result state (and **cost** or **reward**)
- ▶ Goal test : Are we done?

# A Search Problem

- ▶ **State space** (including Start/Initial state): position, board configuration,
- ▶ **Actions** : drive to, Up, Down, Left ...
- ▶ **Transition model** : Given state and action result state (and **cost** or **reward**)
- ▶ **Goal test** : Are we done?



# Discrete State Space

**State space graph:** a representation of a search problem

- ▶ States  $s \in \mathcal{S} = \{\mathbf{S}, \mathbf{A}, \mathbf{B}, \mathbf{C}, \mathbf{D}, \mathbf{G}\}$  (finite set)
- ▶ Arcs represent actions  $a$ , for each state  $s$ ,  $a \in \mathcal{A}(s)$  ( $\mathcal{A}$  is also finite)
- ▶ State transition function  $s' = \text{result}(s, a)$
- ▶ Start (initial) state  $s_0 \in \mathcal{S}$ ,  $s_0 = \mathbf{S}$ .
- ▶ Goal set  $\mathcal{S}_G \subset \mathcal{S}$ .

Each state occurs only *once* in a state (search) space.

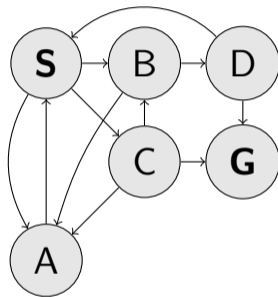

# agent – problem dialog (a programmer's viewpoint)

(search) agent

```
Q.insert( $s_0$ )  
 $s \leftarrow$  Q.pop_first()
```

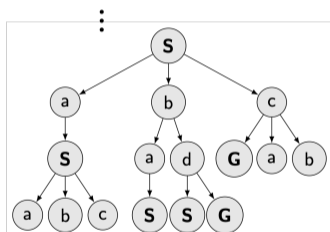

problem - env

$s_0, \mathcal{S}_G = \text{env.reset}()$

$\mathcal{A} = \text{env.get\_actions}(s_0)$

$s' = \text{env.apply\_transition}(s, a)$

⋮

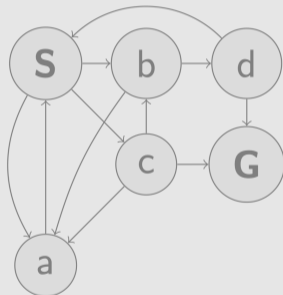

## BFS, Q is FIFO data structure (queue)

```
1: function FORWARD_SEARCH
2:   Q.insert(.,  $s_0$ ) and mark  $s_0$  as visited
3:   while Q not empty do
4:      $p, s \leftarrow$  Q.pop()
5:     parent[s]  $\leftarrow$   $p$ 
6:     if  $s \in \mathcal{S}_G$  then return Success
7:     for all  $a \in \mathcal{A}(s)$  do
8:        $s' \leftarrow$  result( $s, a$ )
9:       if  $s'$  not visited then
10:        Mark  $s'$  as visited
11:        Q.insert( $s, s'$ )
12:       else
13:        Resolve duplicate  $s'$ 
return Failure
```



Q: (., S)  
visited: S

## BFS, Q is FIFO data structure (queue)

```
1: function FORWARD_SEARCH
2:   Q.insert(.,  $s_0$ ) and mark  $s_0$  as visited
3:   while Q not empty do
4:      $p, s \leftarrow$  Q.pop()
5:     parent[s]  $\leftarrow$   $p$ 
6:     if  $s \in \mathcal{S}_G$  then return Success
7:     for all  $a \in \mathcal{A}(s)$  do
8:        $s' \leftarrow$  result( $s, a$ )
9:       if  $s'$  not visited then
10:        Mark  $s'$  as visited
11:        Q.insert( $s, s'$ )
12:       else
13:        Resolve duplicate  $s'$ 
return Failure
```

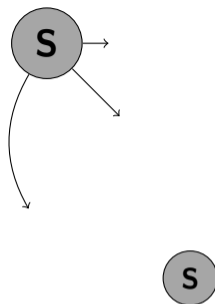

Q:  
visited: S

## BFS, Q is FIFO data structure (queue)

```
1: function FORWARD_SEARCH
2:   Q.insert(., s0) and mark s0 as visited
3:   while Q not empty do
4:     p, s ← Q.pop()
5:     parent[s] ← p
6:     if s ∈ SG then return Success
7:     for all a ∈ A(s) do
8:       s' ← result(s, a)
9:       if s' not visited then
10:        Mark s' as visited
11:        Q.insert(s, s')
12:     else
13:       Resolve duplicate s'
return Failure
```

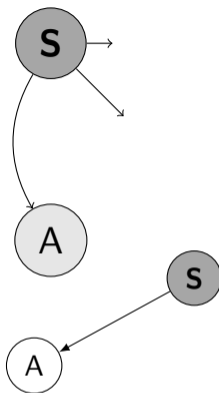

Q:  
visited: S

## BFS, Q is FIFO data structure (queue)

```
1: function FORWARD_SEARCH
2:   Q.insert(., s0) and mark s0 as visited
3:   while Q not empty do
4:     p, s ← Q.pop()
5:     parent[s] ← p
6:     if s ∈ SG then return Success
7:     for all a ∈ A(s) do
8:       s' ← result(s, a)
9:       if s' not visited then
10:        Mark s' as visited
11:        Q.insert(s, s')
12:     else
13:       Resolve duplicate s'
return Failure
```

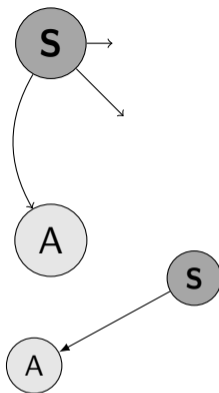

Q: (S,A)  
visited: S A

## BFS, Q is FIFO data structure (queue)

```
1: function FORWARD_SEARCH
2:   Q.insert(., s0) and mark s0 as visited
3:   while Q not empty do
4:     p, s ← Q.pop()
5:     parent[s] ← p
6:     if s ∈ SG then return Success
7:     for all a ∈ A(s) do
8:       s' ← result(s, a)
9:       if s' not visited then
10:        Mark s' as visited
11:        Q.insert(s, s')
12:     else
13:       Resolve duplicate s'
return Failure
```

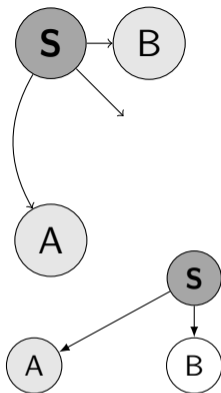

Q: (S,A)  
visited: S A

## BFS, Q is FIFO data structure (queue)

```
1: function FORWARD_SEARCH
2:   Q.insert(., s0) and mark s0 as visited
3:   while Q not empty do
4:     p, s ← Q.pop()
5:     parent[s] ← p
6:     if s ∈ SG then return Success
7:     for all a ∈ A(s) do
8:       s' ← result(s, a)
9:       if s' not visited then
10:        Mark s' as visited
11:        Q.insert(s, s')
12:     else
13:       Resolve duplicate s'
return Failure
```

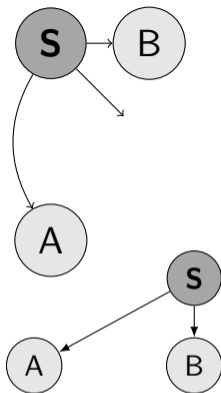

Q: (S,A) (S,B)

visited: S A B



## BFS, Q is FIFO data structure (queue)

```
1: function FORWARD_SEARCH
2:   Q.insert(., s0) and mark s0 as visited
3:   while Q not empty do
4:     p, s ← Q.pop()
5:     parent[s] ← p
6:     if s ∈ SG then return Success
7:     for all a ∈ A(s) do
8:       s' ← result(s, a)
9:       if s' not visited then
10:        Mark s' as visited
11:        Q.insert(s, s')
12:     else
13:       Resolve duplicate s'
return Failure
```

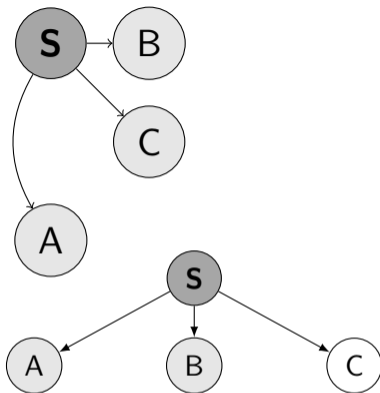

Q: (S,A) (S,B)

visited: S A B

## BFS, Q is FIFO data structure (queue)

```
1: function FORWARD_SEARCH
2:   Q.insert(., s0) and mark s0 as visited
3:   while Q not empty do
4:     p, s ← Q.pop()
5:     parent[s] ← p
6:     if s ∈ SG then return Success
7:     for all a ∈ A(s) do
8:       s' ← result(s, a)
9:       if s' not visited then
10:        Mark s' as visited
11:        Q.insert(s, s')
12:     else
13:       Resolve duplicate s'
return Failure
```

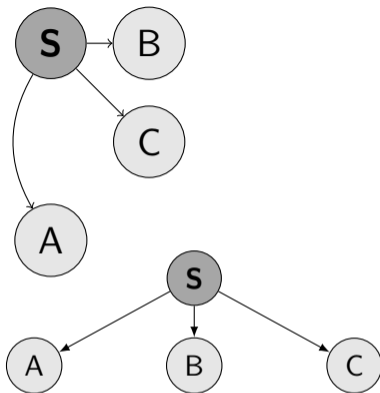

Q: (S,A) (S,B) (S,C)

visited: **S** A B C

## BFS, Q is FIFO data structure (queue)

```
1: function FORWARD_SEARCH
2:   Q.insert(., s0) and mark s0 as visited
3:   while Q not empty do
4:     p, s ← Q.pop()
5:     parent[s] ← p
6:     if s ∈ SG then return Success
7:     for all a ∈ A(s) do
8:       s' ← result(s, a)
9:       if s' not visited then
10:        Mark s' as visited
11:        Q.insert(s, s')
12:       else
13:        Resolve duplicate s'
return Failure
```

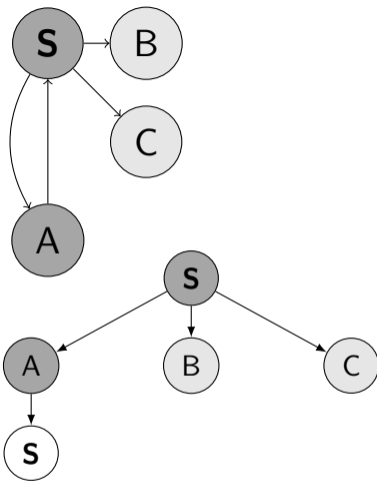

Q: (S,B) (S,C)  
visited: S A B C

## BFS, Q is FIFO data structure (queue)

```
1: function FORWARD_SEARCH
2:   Q.insert(., s0) and mark s0 as visited
3:   while Q not empty do
4:     p, s ← Q.pop()
5:     parent[s] ← p
6:     if s ∈ SG then return Success
7:     for all a ∈ A(s) do
8:       s' ← result(s, a)
9:       if s' not visited then
10:        Mark s' as visited
11:        Q.insert(s, s')
12:       else
13:        Resolve duplicate s'
return Failure
```

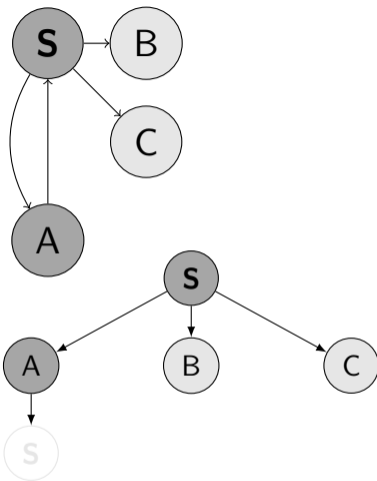

Q: (S,B) (S,C)

visited: S A B C

## BFS, Q is FIFO data structure (queue)

```
1: function FORWARD_SEARCH
2:   Q.insert(., s0) and mark s0 as visited
3:   while Q not empty do
4:     p, s ← Q.pop()
5:     parent[s] ← p
6:     if s ∈ SG then return Success
7:     for all a ∈ A(s) do
8:       s' ← result(s, a)
9:       if s' not visited then
10:        Mark s' as visited
11:        Q.insert(s, s')
12:       else
13:        Resolve duplicate s'
return Failure
```

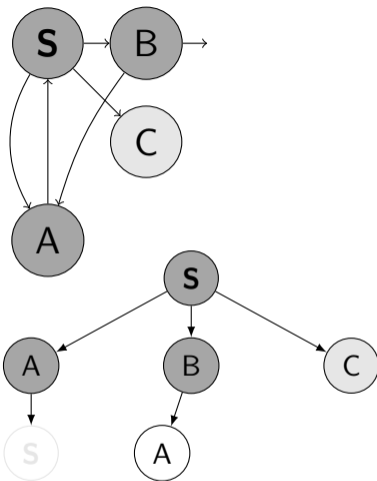

Q: (S,C)  
visited: S A B C

## BFS, Q is FIFO data structure (queue)

```
1: function FORWARD_SEARCH
2:   Q.insert(., s0) and mark s0 as visited
3:   while Q not empty do
4:     p, s ← Q.pop()
5:     parent[s] ← p
6:     if s ∈ SG then return Success
7:     for all a ∈ A(s) do
8:       s' ← result(s, a)
9:       if s' not visited then
10:        Mark s' as visited
11:        Q.insert(s, s')
12:       else
13:        Resolve duplicate s'
return Failure
```

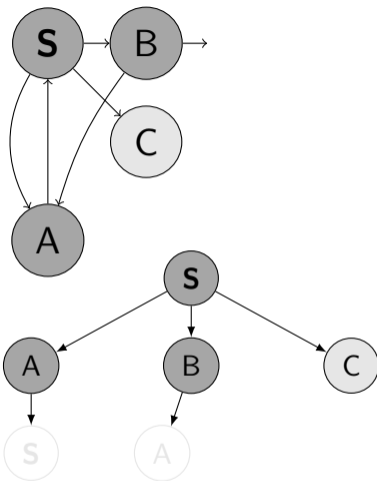

Q: (S,C)  
visited: S A B C

## BFS, Q is FIFO data structure (queue)

```
1: function FORWARD_SEARCH
2:   Q.insert(., s0) and mark s0 as visited
3:   while Q not empty do
4:     p, s ← Q.pop()
5:     parent[s] ← p
6:     if s ∈ SG then return Success
7:     for all a ∈ A(s) do
8:       s' ← result(s, a)
9:       if s' not visited then
10:        Mark s' as visited
11:        Q.insert(s, s')
12:       else
13:        Resolve duplicate s'
return Failure
```

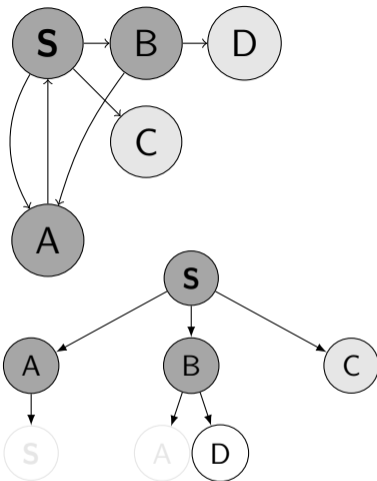

Q: (S,C)  
visited: S A B C

## BFS, Q is FIFO data structure (queue)

```
1: function FORWARD_SEARCH
2:   Q.insert(., s0) and mark s0 as visited
3:   while Q not empty do
4:     p, s ← Q.pop()
5:     parent[s] ← p
6:     if s ∈ SG then return Success
7:     for all a ∈ A(s) do
8:       s' ← result(s, a)
9:       if s' not visited then
10:        Mark s' as visited
11:        Q.insert(s, s')
12:       else
13:        Resolve duplicate s'
return Failure
```

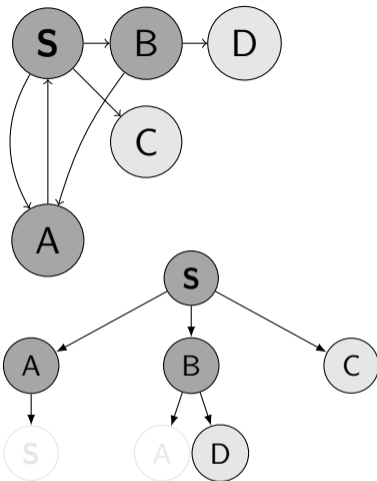

Q: (S,C) (B,D)  
visited: S A B C D



## BFS, Q is FIFO data structure (queue)

```
1: function FORWARD_SEARCH
2:   Q.insert(., s0) and mark s0 as visited
3:   while Q not empty do
4:     p, s ← Q.pop()
5:     parent[s] ← p
6:     if s ∈ SG then return Success
7:     for all a ∈ A(s) do
8:       s' ← result(s, a)
9:       if s' not visited then
10:        Mark s' as visited
11:        Q.insert(s, s')
12:     else
13:       Resolve duplicate s'
return Failure
```

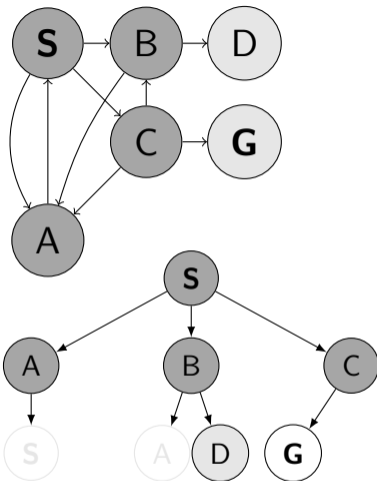

Q: (B,D)  
visited: S A B C D

## BFS, Q is FIFO data structure (queue)

```
1: function FORWARD_SEARCH
2:   Q.insert(., s0) and mark s0 as visited
3:   while Q not empty do
4:     p, s ← Q.pop()
5:     parent[s] ← p
6:     if s ∈ SG then return Success
7:     for all a ∈ A(s) do
8:       s' ← result(s, a)
9:       if s' not visited then
10:        Mark s' as visited
11:        Q.insert(s, s')
12:     else
13:       Resolve duplicate s'
return Failure
```

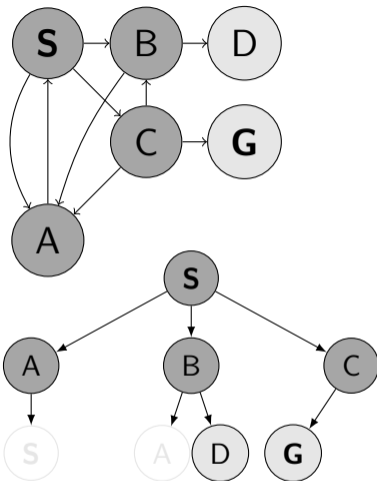

Q: (B,D) (C,G)  
visited: S A B C D G

## BFS, Q is FIFO data structure (queue)

```
1: function FORWARD_SEARCH
2:   Q.insert(., s0) and mark s0 as visited
3:   while Q not empty do
4:     p, s ← Q.pop()
5:     parent[s] ← p
6:     if s ∈ SG then return Success
7:     for all a ∈ A(s) do
8:       s' ← result(s, a)
9:       if s' not visited then
10:        Mark s' as visited
11:        Q.insert(s, s')
12:     else
13:       Resolve duplicate s'
return Failure
```

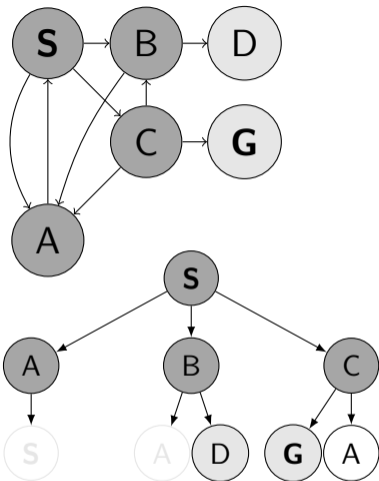

Q: (B,D) (C,G)  
visited: S A B C D G

## BFS, Q is FIFO data structure (queue)

```
1: function FORWARD_SEARCH
2:   Q.insert(., s0) and mark s0 as visited
3:   while Q not empty do
4:     p, s ← Q.pop()
5:     parent[s] ← p
6:     if s ∈ SG then return Success
7:     for all a ∈ A(s) do
8:       s' ← result(s, a)
9:       if s' not visited then
10:        Mark s' as visited
11:        Q.insert(s, s')
12:     else
13:       Resolve duplicate s'
return Failure
```

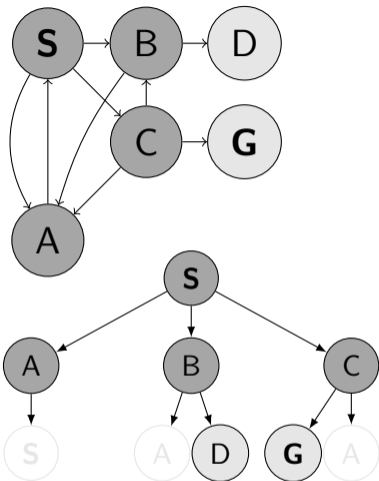

Q: (B,D) (C,G)  
visited: S A B C D G

## BFS, Q is FIFO data structure (queue)

```
1: function FORWARD_SEARCH
2:   Q.insert(., s0) and mark s0 as visited
3:   while Q not empty do
4:     p, s ← Q.pop()
5:     parent[s] ← p
6:     if s ∈ SG then return Success
7:     for all a ∈ A(s) do
8:       s' ← result(s, a)
9:       if s' not visited then
10:        Mark s' as visited
11:        Q.insert(s, s')
12:     else
13:       Resolve duplicate s'
return Failure
```

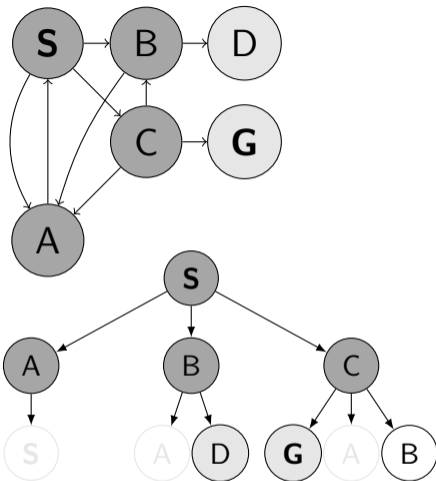

Q: (B,D) (C,G)  
visited: S A B C D G

## BFS, Q is FIFO data structure (queue)

```
1: function FORWARD_SEARCH
2:   Q.insert(., s0) and mark s0 as visited
3:   while Q not empty do
4:     p, s ← Q.pop()
5:     parent[s] ← p
6:     if s ∈ SG then return Success
7:     for all a ∈ A(s) do
8:       s' ← result(s, a)
9:       if s' not visited then
10:        Mark s' as visited
11:        Q.insert(s, s')
12:     else
13:       Resolve duplicate s'
return Failure
```

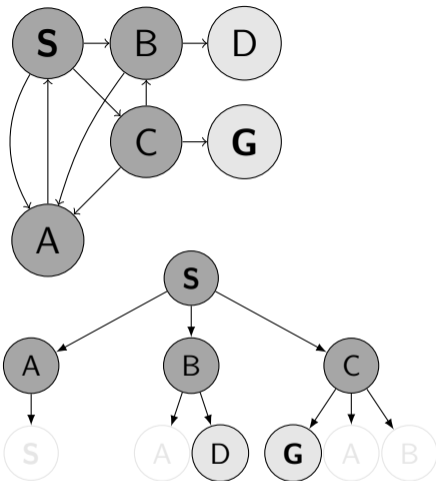

Q: (B,D) (C,G)  
visited: S A B C D G

## BFS, Q is FIFO data structure (queue)

```
1: function FORWARD_SEARCH
2:   Q.insert(., s0) and mark s0 as visited
3:   while Q not empty do
4:     p, s ← Q.pop()
5:     parent[s] ← p
6:     if s ∈ SG then return Success
7:     for all a ∈ A(s) do
8:       s' ← result(s, a)
9:       if s' not visited then
10:        Mark s' as visited
11:        Q.insert(s, s')
12:     else
13:       Resolve duplicate s'
return Failure
```

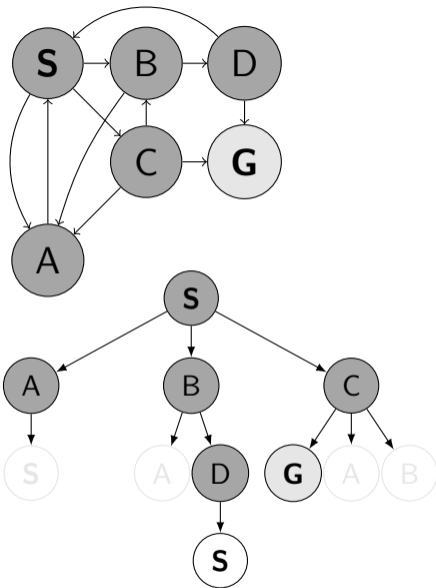

## BFS, Q is FIFO data structure (queue)

```
1: function FORWARD_SEARCH
2:   Q.insert(., s0) and mark s0 as visited
3:   while Q not empty do
4:     p, s ← Q.pop()
5:     parent[s] ← p
6:     if s ∈ SG then return Success
7:     for all a ∈ A(s) do
8:       s' ← result(s, a)
9:       if s' not visited then
10:        Mark s' as visited
11:        Q.insert(s, s')
12:       else
13:        Resolve duplicate s'
return Failure
```

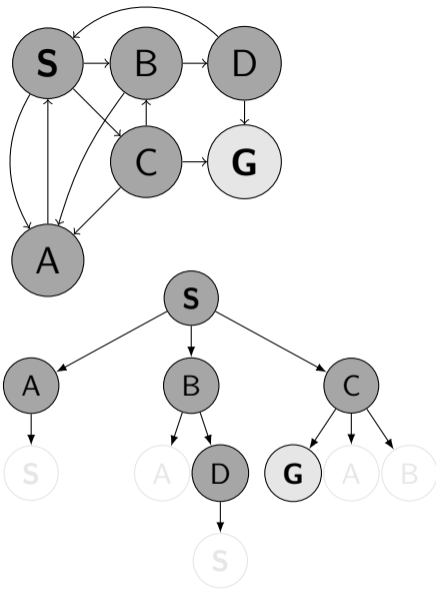

Q: (C, G)  
visited: S A B C D G



## BFS, Q is FIFO data structure (queue)

```
1: function FORWARD_SEARCH
2:   Q.insert(., s0) and mark s0 as visited
3:   while Q not empty do
4:     p, s ← Q.pop()
5:     parent[s] ← p
6:     if s ∈ SG then return Success
7:     for all a ∈ A(s) do
8:       s' ← result(s, a)
9:       if s' not visited then
10:        Mark s' as visited
11:        Q.insert(s, s')
12:     else
13:       Resolve duplicate s'
return Failure
```

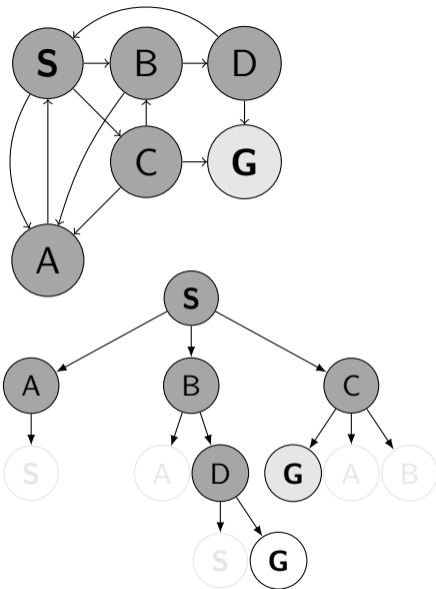

## BFS, Q is FIFO data structure (queue)

```
1: function FORWARD_SEARCH
2:   Q.insert(., s0) and mark s0 as visited
3:   while Q not empty do
4:     p, s ← Q.pop()
5:     parent[s] ← p
6:     if s ∈ SG then return Success
7:     for all a ∈ A(s) do
8:       s' ← result(s, a)
9:       if s' not visited then
10:        Mark s' as visited
11:        Q.insert(s, s')
12:     else
13:       Resolve duplicate s'
return Failure
```

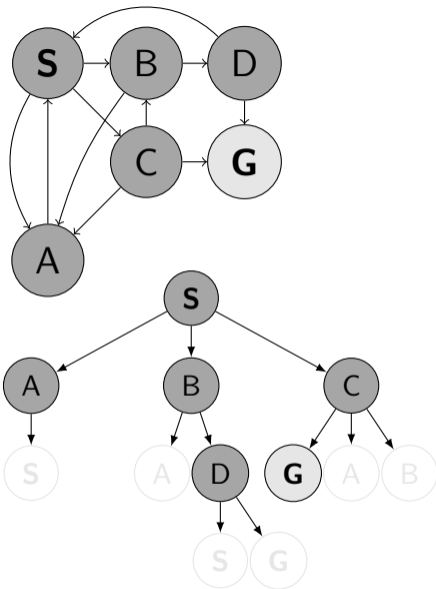

## BFS, Q is FIFO data structure (queue)

```
1: function FORWARD_SEARCH
2:   Q.insert(., s0) and mark s0 as visited
3:   while Q not empty do
4:     p, s ← Q.pop()
5:     parent[s] ← p
6:     if s ∈ SG then return Success
7:     for all a ∈ A(s) do
8:       s' ← result(s, a)
9:       if s' not visited then
10:        Mark s' as visited
11:        Q.insert(s, s')
12:     else
13:       Resolve duplicate s'
return Failure
```

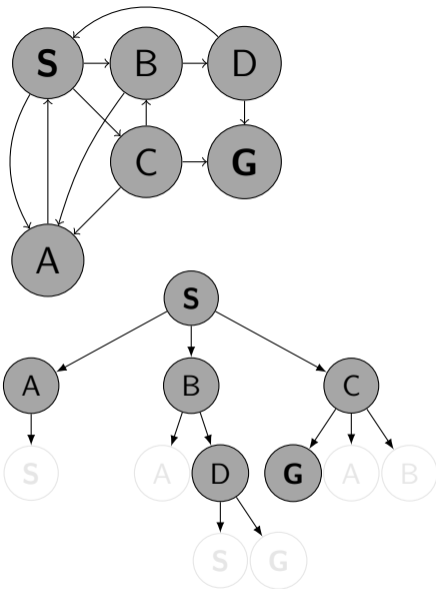

Q:  
visited: S A B C D G

Search algorithm partitions state space into 3 disjoint sets



Find good names

## Search algorithm partitions state space into 3 disjoint sets

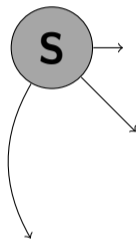

Find good names

## Search algorithm partitions state space into 3 disjoint sets

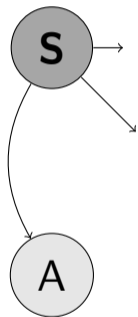

Find good names

## Search algorithm partitions state space into 3 disjoint sets

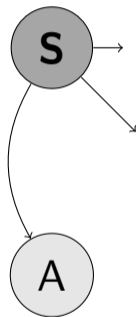

Find good names

## Search algorithm partitions state space into 3 disjoint sets

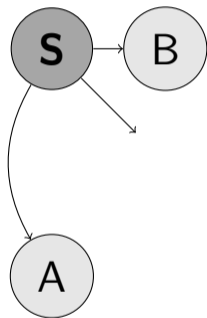

Find good names



## Search algorithm partitions state space into 3 disjoint sets

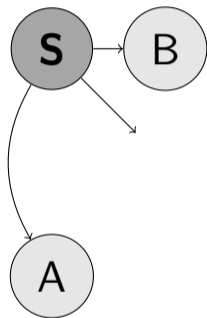

Find good names

## Search algorithm partitions state space into 3 disjoint sets

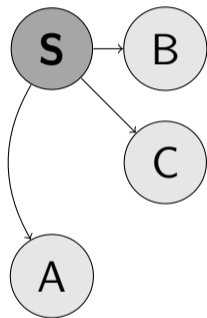

Find good names

## Search algorithm partitions state space into 3 disjoint sets

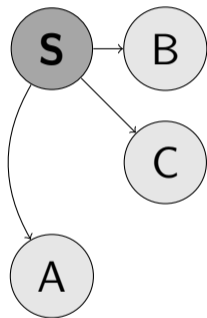

Find good names

## Search algorithm partitions state space into 3 disjoint sets

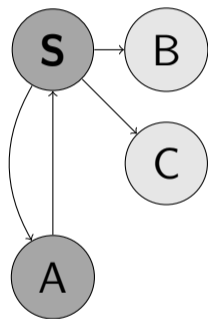

Find good names

## Search algorithm partitions state space into 3 disjoint sets

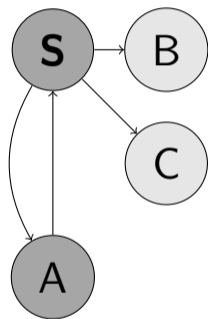

Find good names

## Search algorithm partitions state space into 3 disjoint sets

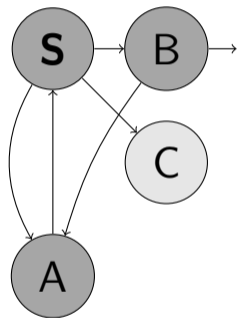

Find good names

## Search algorithm partitions state space into 3 disjoint sets

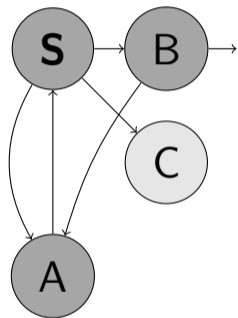

Find good names

## Search algorithm partitions state space into 3 disjoint sets

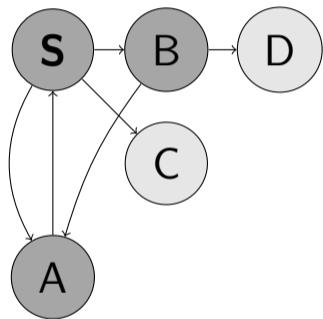

Find good names



## Search algorithm partitions state space into 3 disjoint sets

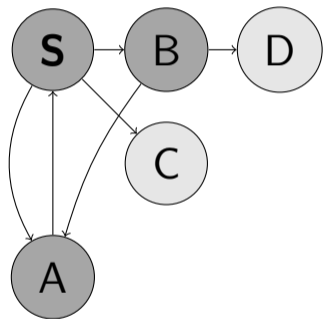

Find good names

## Search algorithm partitions state space into 3 disjoint sets

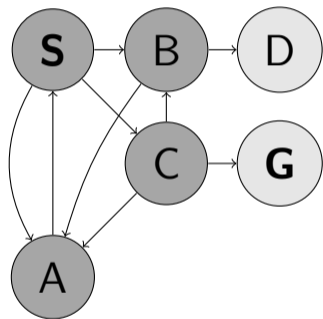

Find good names

## Search algorithm partitions state space into 3 disjoint sets

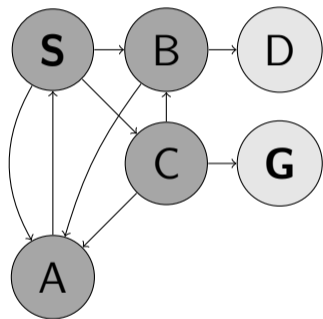

Find good names

## Search algorithm partitions state space into 3 disjoint sets

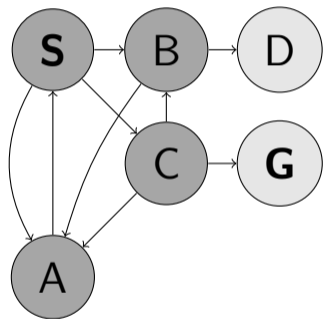

Find good names

## Search algorithm partitions state space into 3 disjoint sets

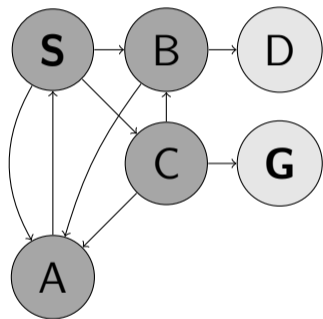

Find good names

## Search algorithm partitions state space into 3 disjoint sets

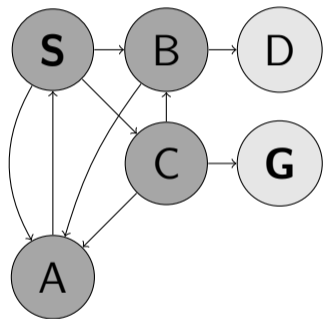

Find good names

## Search algorithm partitions state space into 3 disjoint sets

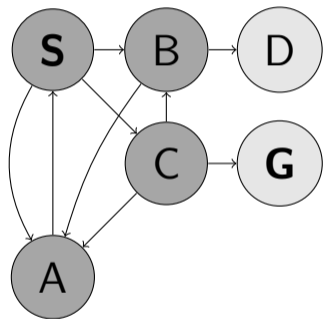

Find good names

## Search algorithm partitions state space into 3 disjoint sets

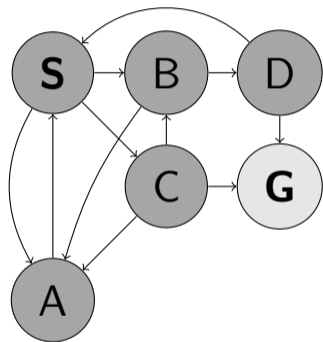

Find good names



## Search algorithm partitions state space into 3 disjoint sets

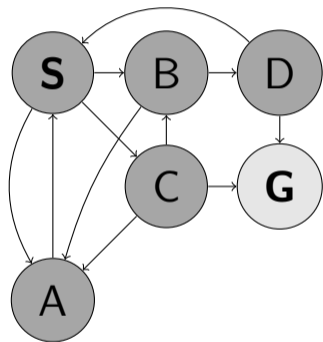

Find good names

## Search algorithm partitions state space into 3 disjoint sets

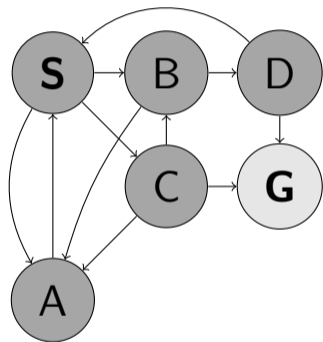

Find good names

## Search algorithm partitions state space into 3 disjoint sets

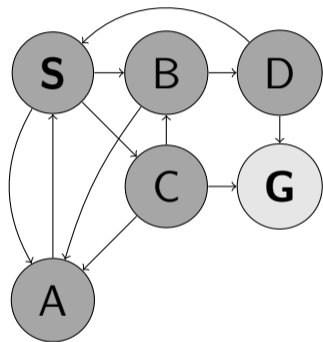

Find good names

## Search algorithm partitions state space into 3 disjoint sets

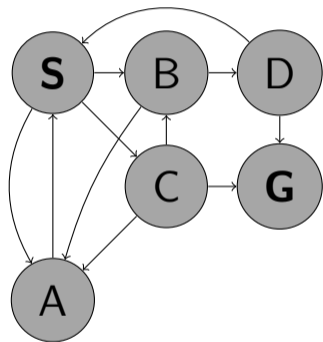

Find good names

## Search (algorithm) properties

- ▶ Guaranteed to find a solution (if exists)? Complete?
- ▶ Guaranteed to find the least cost path? Optimal?
- ▶ How many steps - an operation with a node? Time complexity?
- ▶ How many nodes to remember? Space/Memory complexity?

How many nodes in a (search) tree? What are tree parameters?

## Search (algorithm) properties

- ▶ Guaranteed to find a solution (if exists)? **Complete?**
- ▶ Guaranteed to find the least cost path? **Optimal?**
- ▶ How many steps - an operation with a node? **Time complexity?**
- ▶ How many nodes to remember? **Space/Memory complexity?**

How many nodes in a (search) tree? What are tree parameters?

## Search (algorithm) properties

- ▶ Guaranteed to find a solution (if exists)? **Complete?**
- ▶ Guaranteed to find the least cost path? **Optimal?**
- ▶ How many steps - an operation with a node? **Time complexity?**
- ▶ How many nodes to remember? **Space/Memory complexity?**

How many nodes in a (search) tree? What are tree parameters?

## Search (algorithm) properties

- ▶ Guaranteed to find a solution (if exists)? **Complete?**
- ▶ Guaranteed to find the least cost path? **Optimal?**
- ▶ How many steps - an operation with a node? Time complexity?
- ▶ How many nodes to remember? Space/Memory complexity?

How many nodes in a (search) tree? What are tree parameters?



## Search (algorithm) properties

- ▶ Guaranteed to find a solution (if exists)? **Complete?**
- ▶ Guaranteed to find the least cost path? **Optimal?**
- ▶ How many steps - an operation with a node? Time complexity?
- ▶ How many nodes to remember? Space/Memory complexity?

How many nodes in a (search) tree? What are tree parameters?

## Search (algorithm) properties

- ▶ Guaranteed to find a solution (if exists)? **Complete?**
- ▶ Guaranteed to find the least cost path? **Optimal?**
- ▶ How many steps - an operation with a node? **Time** complexity?
- ▶ How many nodes to remember? **Space/Memory** complexity?

How many nodes in a (search) tree? What are tree parameters?

## Search (algorithm) properties

- ▶ Guaranteed to find a solution (if exists)? **Complete?**
- ▶ Guaranteed to find the least cost path? **Optimal?**
- ▶ How many steps - an operation with a node? **Time** complexity?
- ▶ How many nodes to remember? **Space/Memory** complexity?

How many nodes in a (search) tree? What are tree parameters?

## Search (algorithm) properties

- ▶ Guaranteed to find a solution (if exists)? **Complete?**
- ▶ Guaranteed to find the least cost path? **Optimal?**
- ▶ How many steps - an operation with a node? **Time** complexity?
- ▶ How many nodes to remember? **Space/Memory** complexity?

How many nodes in a (search) tree? What are tree parameters?

## Search (algorithm) properties

- ▶ Guaranteed to find a solution (if exists)? **Complete?**
- ▶ Guaranteed to find the least cost path? **Optimal?**
- ▶ How many steps - an operation with a node? **Time** complexity?
- ▶ How many nodes to remember? **Space/Memory** complexity?

How many nodes in a (search) tree? **What are tree parameters?**

## Search (algorithm) properties

- ▶ Guaranteed to find a solution (if exists)? **Complete?**
- ▶ Guaranteed to find the least cost path? **Optimal?**
- ▶ How many steps - an operation with a node? **Time** complexity?
- ▶ How many nodes to remember? **Space/Memory** complexity?

How many nodes in a (search) tree? What are tree parameters?

# Strategies

How to traverse/build a search tree?

- ▶ **Depth**  $d$  of a node in the tree.
- ▶ **Max-Depth** of the tree  $m$ . Can be  $\infty$ .
- ▶ (Average) **Branching** factor  $b$ .
- ▶  $s$  denotes the depth of the **shallowest Goal**.
- ▶ How many nodes in the whole tree?

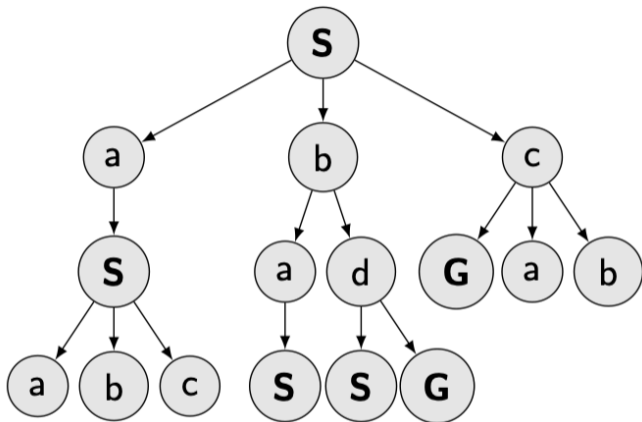

# Strategies

How to traverse/build a search tree?

- ▶ **Depth**  $d$  of a node in the tree.
- ▶ **Max-Depth** of the tree  $m$ . Can be  $\infty$ .
- ▶ (Average) **Branching** factor  $b$ .
- ▶  $s$  denotes the depth of the **shallowest Goal**.
- ▶ How many nodes in the whole tree?

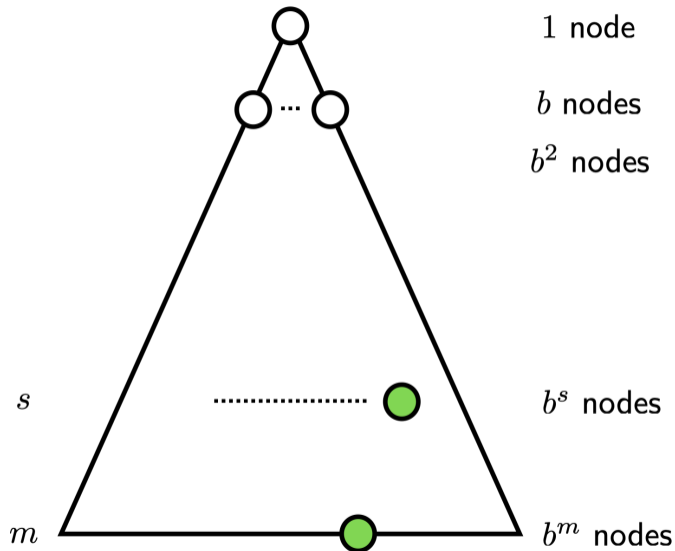



# BFS properties

Complete?

Optimal?

Time complexity?

A  $O(bm)$

B  $O(b^m)$

C  $O(m^b)$

D  $O(b^s)$

Space complexity?

A  $O(bm)$

B  $O(b^m)$

C  $O(m^b)$

D  $O(b^s)$

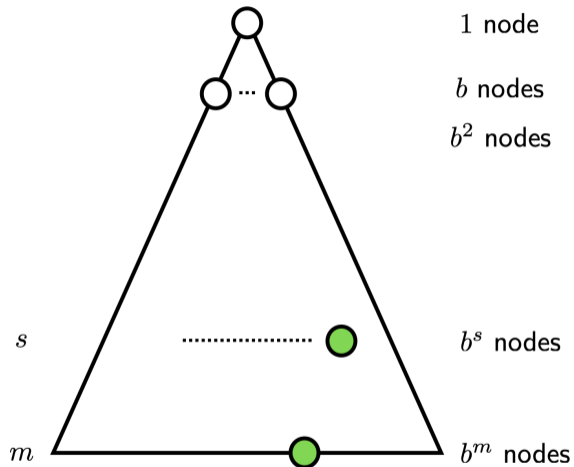

# BFS properties

Complete?

Optimal?

Time complexity?

A  $O(bm)$

B  $O(b^m)$

C  $O(m^b)$

D  $O(b^s)$

Space complexity?

A  $O(bm)$

B  $O(b^m)$

C  $O(m^b)$

D  $O(b^s)$

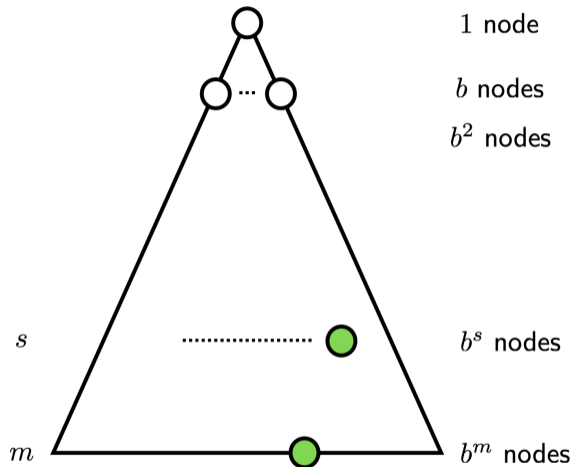

# BFS properties

Complete?

Optimal?

Time complexity?

**A**  $\mathcal{O}(bm)$

**B**  $\mathcal{O}(b^m)$

**C**  $\mathcal{O}(m^b)$

**D**  $\mathcal{O}(b^s)$

Space complexity?

**A**  $\mathcal{O}(bm)$

**B**  $\mathcal{O}(b^m)$

**C**  $\mathcal{O}(m^b)$

**D**  $\mathcal{O}(b^s)$

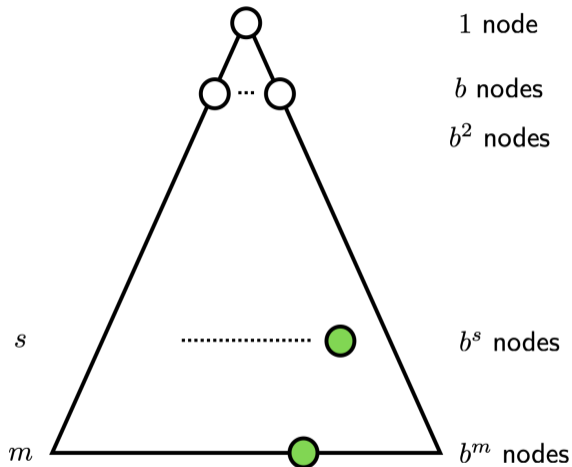

# BFS properties

Complete?

Optimal?

Time complexity?

**A**  $\mathcal{O}(bm)$

**B**  $\mathcal{O}(b^m)$

**C**  $\mathcal{O}(m^b)$

**D**  $\mathcal{O}(b^s)$

Space complexity?

**A**  $\mathcal{O}(bm)$

**B**  $\mathcal{O}(b^m)$

**C**  $\mathcal{O}(m^b)$

**D**  $\mathcal{O}(b^s)$

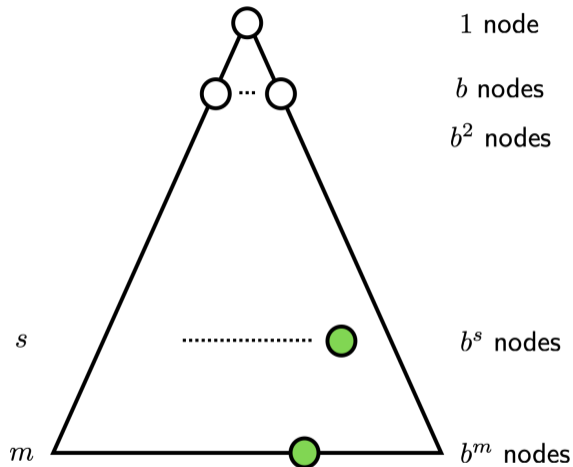

## DFS, Q is LIFO data structure (stack)

```
1: function FORWARD_SEARCH
2:   Q.insert(., s0) and mark s0 as visited
3:   while Q not empty do
4:     p, s ← Q.pop()
5:     parent[s] ← p
6:     if s ∈ SG then return Success
7:     for all a ∈ A(s) do
8:       s' ← result(s, a)
9:       if s' not visited then
10:        Mark s' as visited
11:        Q.insert(s, s')
12:       else
13:        Resolve duplicate s'
return Failure
```

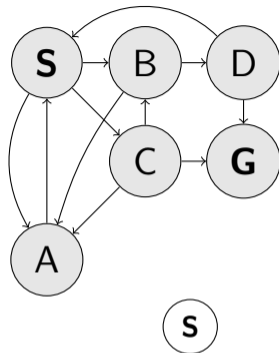

Q: (., S)  
visited: S

## DFS, Q is LIFO data structure (stack)

```
1: function FORWARD_SEARCH
2:   Q.insert(., s0) and mark s0 as visited
3:   while Q not empty do
4:     p, s ← Q.pop()
5:     parent[s] ← p
6:     if s ∈ SG then return Success
7:     for all a ∈ A(s) do
8:       s' ← result(s, a)
9:       if s' not visited then
10:         Mark s' as visited
11:         Q.insert(s, s')
12:       else
13:         Resolve duplicate s'
return Failure
```

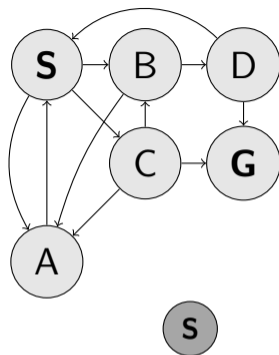

Q:  
visited: S

## DFS, Q is LIFO data structure (stack)

```
1: function FORWARD_SEARCH
2:   Q.insert(., s0) and mark s0 as visited
3:   while Q not empty do
4:     p, s ← Q.pop()
5:     parent[s] ← p
6:     if s ∈ SG then return Success
7:     for all a ∈ A(s) do
8:       s' ← result(s, a)
9:       if s' not visited then
10:        Mark s' as visited
11:        Q.insert(s, s')
12:     else
13:       Resolve duplicate s'
return Failure
```

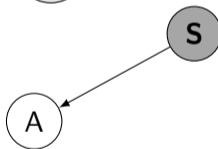
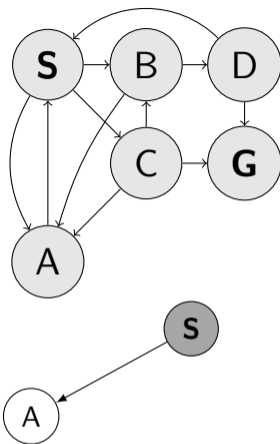

Q:  
visited: S

## DFS, Q is LIFO data structure (stack)

```
1: function FORWARD_SEARCH
2:   Q.insert(., s0) and mark s0 as visited
3:   while Q not empty do
4:     p, s ← Q.pop()
5:     parent[s] ← p
6:     if s ∈ SG then return Success
7:     for all a ∈ A(s) do
8:       s' ← result(s, a)
9:       if s' not visited then
10:        Mark s' as visited
11:        Q.insert(s, s')
12:     else
13:       Resolve duplicate s'
return Failure
```

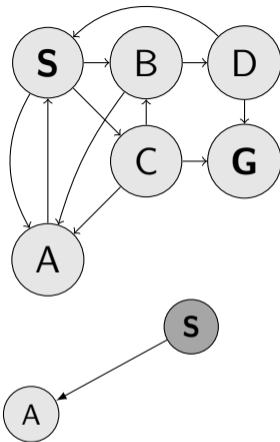

Q: (S,A)  
visited: S A



## DFS, Q is LIFO data structure (stack)

```
1: function FORWARD_SEARCH
2:   Q.insert(., s0) and mark s0 as visited
3:   while Q not empty do
4:     p, s ← Q.pop()
5:     parent[s] ← p
6:     if s ∈ SG then return Success
7:     for all a ∈ A(s) do
8:       s' ← result(s, a)
9:       if s' not visited then
10:        Mark s' as visited
11:        Q.insert(s, s')
12:     else
13:       Resolve duplicate s'
return Failure
```

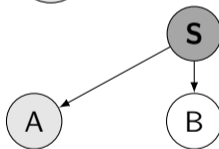
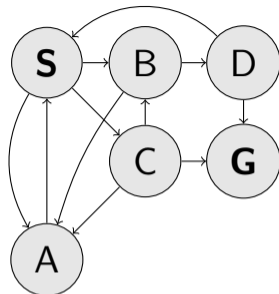

Q: (S,A)  
visited: S A

## DFS, Q is LIFO data structure (stack)

```
1: function FORWARD_SEARCH
2:   Q.insert(., s0) and mark s0 as visited
3:   while Q not empty do
4:     p, s ← Q.pop()
5:     parent[s] ← p
6:     if s ∈ SG then return Success
7:     for all a ∈ A(s) do
8:       s' ← result(s, a)
9:       if s' not visited then
10:        Mark s' as visited
11:        Q.insert(s, s')
12:     else
13:       Resolve duplicate s'
return Failure
```

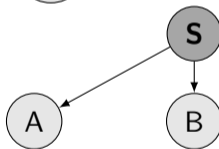
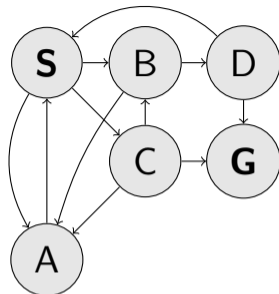

Q: (S,A) (S,B)  
visited: **S** A B

## DFS, Q is LIFO data structure (stack)

```
1: function FORWARD_SEARCH
2:   Q.insert(., s0) and mark s0 as visited
3:   while Q not empty do
4:     p, s ← Q.pop()
5:     parent[s] ← p
6:     if s ∈ SG then return Success
7:     for all a ∈ A(s) do
8:       s' ← result(s, a)
9:       if s' not visited then
10:        Mark s' as visited
11:        Q.insert(s, s')
12:     else
13:       Resolve duplicate s'
return Failure
```

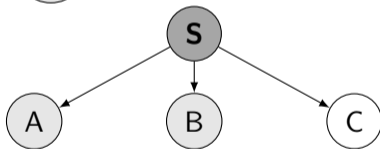
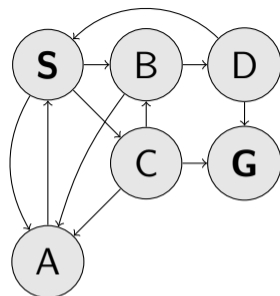

Q: (S,A) (S,B)  
visited: **S** A B

## DFS, Q is LIFO data structure (stack)

```
1: function FORWARD_SEARCH
2:   Q.insert(., s0) and mark s0 as visited
3:   while Q not empty do
4:     p, s ← Q.pop()
5:     parent[s] ← p
6:     if s ∈ SG then return Success
7:     for all a ∈ A(s) do
8:       s' ← result(s, a)
9:       if s' not visited then
10:        Mark s' as visited
11:        Q.insert(s, s')
12:     else
13:       Resolve duplicate s'
return Failure
```

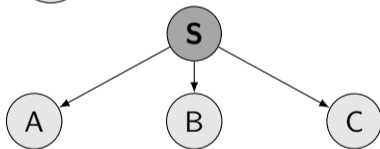
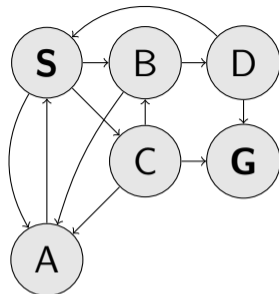

Q: (S,A) (S,B) (S,C)  
visited: **S** A B C

## DFS, Q is LIFO data structure (stack)

```
1: function FORWARD_SEARCH
2:   Q.insert(., s0) and mark s0 as visited
3:   while Q not empty do
4:     p, s ← Q.pop()
5:     parent[s] ← p
6:     if s ∈ SG then return Success
7:     for all a ∈ A(s) do
8:       s' ← result(s, a)
9:       if s' not visited then
10:        Mark s' as visited
11:        Q.insert(s, s')
12:     else
13:       Resolve duplicate s'
return Failure
```

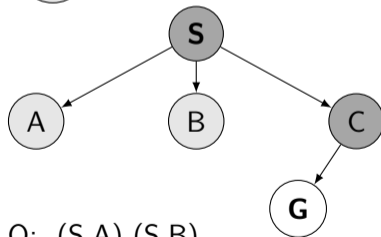
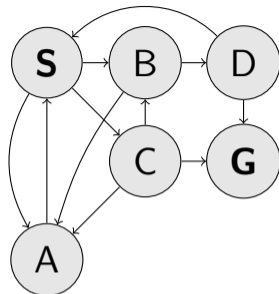

Q: (S,A) (S,B)  
visited: S A B C

## DFS, Q is LIFO data structure (stack)

```
1: function FORWARD_SEARCH
2:   Q.insert(., s0) and mark s0 as visited
3:   while Q not empty do
4:     p, s ← Q.pop()
5:     parent[s] ← p
6:     if s ∈ SG then return Success
7:     for all a ∈ A(s) do
8:       s' ← result(s, a)
9:       if s' not visited then
10:        Mark s' as visited
11:        Q.insert(s, s')
12:     else
13:       Resolve duplicate s'
return Failure
```

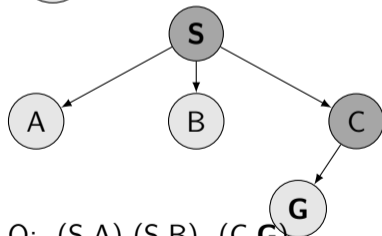
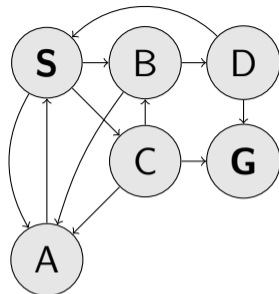

Q: (S,A) (S,B) (C,G)  
visited: S A B C G

## DFS, Q is LIFO data structure (stack)

```
1: function FORWARD_SEARCH
2:   Q.insert(., s0) and mark s0 as visited
3:   while Q not empty do
4:     p, s ← Q.pop()
5:     parent[s] ← p
6:     if s ∈ SG then return Success
7:     for all a ∈ A(s) do
8:       s' ← result(s, a)
9:       if s' not visited then
10:        Mark s' as visited
11:        Q.insert(s, s')
12:     else
13:       Resolve duplicate s'
return Failure
```

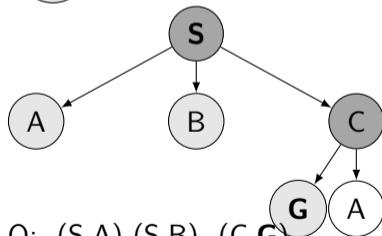
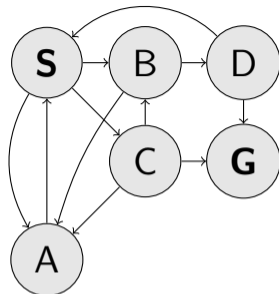

Q: (S,A) (S,B) (C,G)  
visited: S A B C G

## DFS, Q is LIFO data structure (stack)

```
1: function FORWARD_SEARCH
2:   Q.insert(., s0) and mark s0 as visited
3:   while Q not empty do
4:     p, s ← Q.pop()
5:     parent[s] ← p
6:     if s ∈ SG then return Success
7:     for all a ∈ A(s) do
8:       s' ← result(s, a)
9:       if s' not visited then
10:        Mark s' as visited
11:        Q.insert(s, s')
12:     else
13:       Resolve duplicate s'
return Failure
```

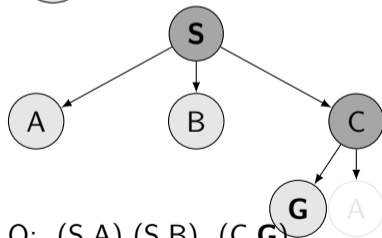
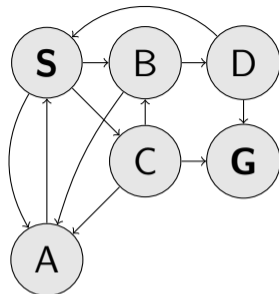

Q: (S,A) (S,B) (C,G)  
visited: S A B C G



## DFS, Q is LIFO data structure (stack)

```
1: function FORWARD_SEARCH
2:   Q.insert(., s0) and mark s0 as visited
3:   while Q not empty do
4:     p, s ← Q.pop()
5:     parent[s] ← p
6:     if s ∈ SG then return Success
7:     for all a ∈ A(s) do
8:       s' ← result(s, a)
9:       if s' not visited then
10:        Mark s' as visited
11:        Q.insert(s, s')
12:     else
13:       Resolve duplicate s'
return Failure
```

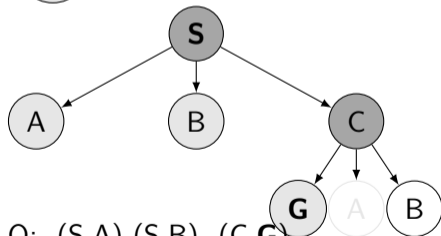
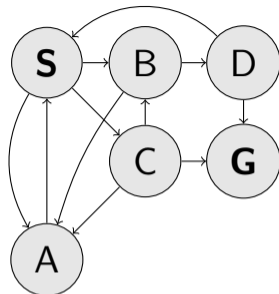

Q: (S,A) (S,B) (C,G)  
visited: S A B C G

## DFS, Q is LIFO data structure (stack)

```
1: function FORWARD_SEARCH
2:   Q.insert(., s0) and mark s0 as visited
3:   while Q not empty do
4:     p, s ← Q.pop()
5:     parent[s] ← p
6:     if s ∈ SG then return Success
7:     for all a ∈ A(s) do
8:       s' ← result(s, a)
9:       if s' not visited then
10:        Mark s' as visited
11:        Q.insert(s, s')
12:     else
13:       Resolve duplicate s'
return Failure
```

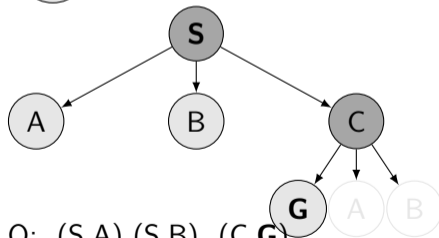
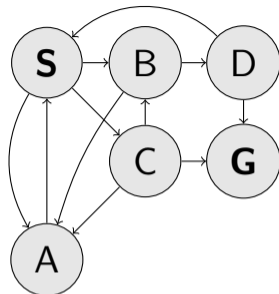

Q: (S,A) (S,B) (C,G)  
visited: S A B C G

## DFS, Q is LIFO data structure (stack)

```
1: function FORWARD_SEARCH
2:   Q.insert(., s0) and mark s0 as visited
3:   while Q not empty do
4:     p, s ← Q.pop()
5:     parent[s] ← p
6:     if s ∈ SG then return Success
7:     for all a ∈ A(s) do
8:       s' ← result(s, a)
9:       if s' not visited then
10:        Mark s' as visited
11:        Q.insert(s, s')
12:     else
13:       Resolve duplicate s'
return Failure
```

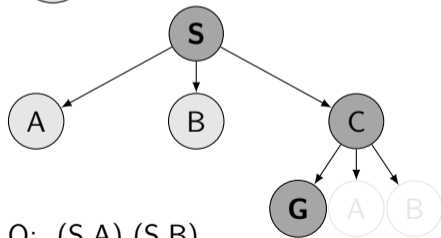
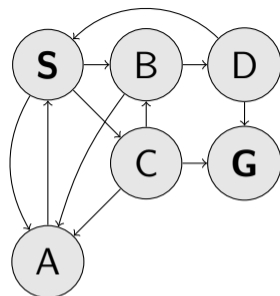

Q: (S,A) (S,B)  
visited: S A B C G

# DFS properties

Complete?

Optimal?

Time complexity?

A  $O(bm)$

B  $O(b^m)$

C  $O(m^b)$

D  $O(b^s)$

Space complexity?

A  $O(bm)$

B  $O(b^m)$

C  $O(m^b)$

D  $O(b^s)$

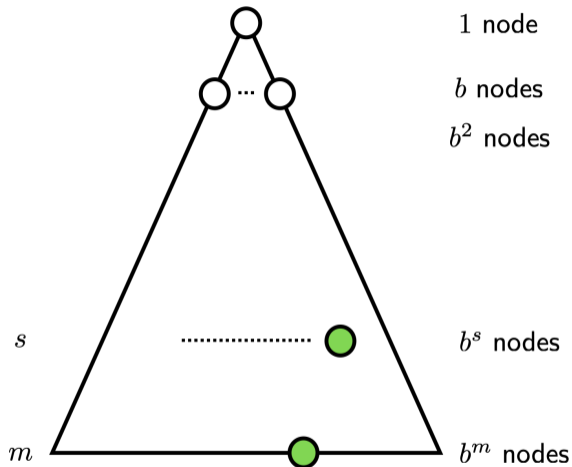

# DFS properties

Complete?

Optimal?

Time complexity?

A  $O(bm)$

B  $O(b^m)$

C  $O(m^b)$

D  $O(b^s)$

Space complexity?

A  $O(bm)$

B  $O(b^m)$

C  $O(m^b)$

D  $O(b^s)$

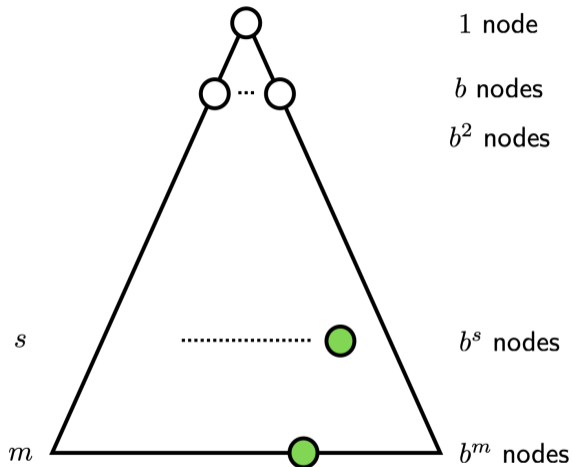

# DFS properties

Complete?

Optimal?

Time complexity?

**A**  $\mathcal{O}(bm)$

**B**  $\mathcal{O}(b^m)$

**C**  $\mathcal{O}(m^b)$

**D**  $\mathcal{O}(b^s)$

Space complexity?

**A**  $\mathcal{O}(bm)$

**B**  $\mathcal{O}(b^m)$

**C**  $\mathcal{O}(m^b)$

**D**  $\mathcal{O}(b^s)$

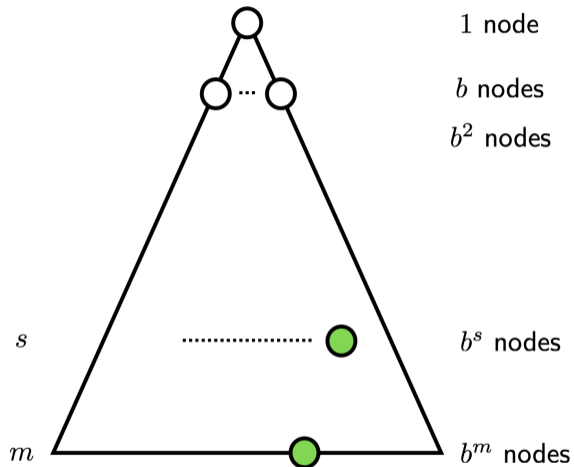

# DFS properties

Complete?

Optimal?

Time complexity?

**A**  $\mathcal{O}(bm)$

**B**  $\mathcal{O}(b^m)$

**C**  $\mathcal{O}(m^b)$

**D**  $\mathcal{O}(b^s)$

Space complexity?

**A**  $\mathcal{O}(bm)$

**B**  $\mathcal{O}(b^m)$

**C**  $\mathcal{O}(m^b)$

**D**  $\mathcal{O}(b^s)$

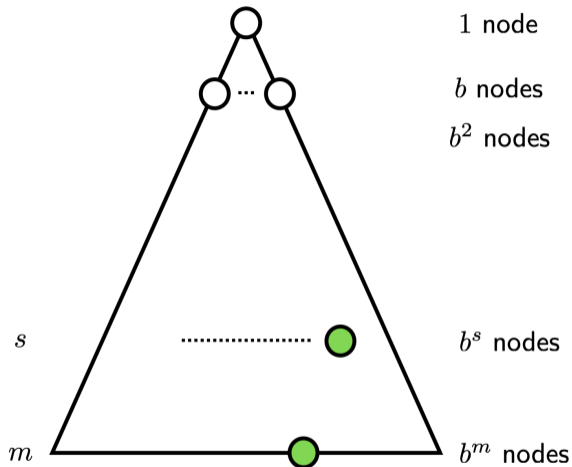

## Iterative deepening DFS (ID-DFS)

- ▶ Start with `maxdepth = 1`
  - ▶ Perform DFS with limited depth. Report success or failure.
  - ▶ If failure, forget everything, increase `maxdepth` and repeat DFS

Is it not a terrible waste to forget everything between steps?



## Iterative deepening DFS (ID-DFS)

- ▶ Start with `maxdepth = 1`
- ▶ Perform DFS with limited depth. Report success or failure.
  - ▶ If failure, forget everything, increase `maxdepth` and repeat DFS

Is it not a terrible waste to forget everything between steps?

## Iterative deepening DFS (ID-DFS)

- ▶ Start with `maxdepth = 1`
- ▶ Perform DFS with limited depth. Report success or failure.
- ▶ If failure, forget everything, increase `maxdepth` and repeat DFS

Is it not a terrible waste to forget everything between steps?

## Iterative deepening DFS (ID-DFS)

- ▶ Start with `maxdepth = 1`
- ▶ Perform DFS with limited depth. Report success or failure.
- ▶ If failure, forget everything, increase `maxdepth` and repeat DFS

Is it not a terrible waste to forget everything between steps?

# Uniform Cost Search (Dijkstra), Q is priority queue

```
1: function FORWARD_SEARCH
2:   Q.insert(., s0, 0) and mark s0 as visited
3:   while Q not empty do
4:     p, s, _ ← Q.pop_first()
5:     parent[s] ← p
6:     if s ∈ SG then return Success
7:     for all a ∈ A(s) do
8:       s', c ← result(s, a)           ▷ c cost
9:       if s' not visited then
10:        Mark s' as visited
11:        Q.insert(s, s', cost_from_start)
12:       else
13:        Resolve duplicate s'
return Failure
```

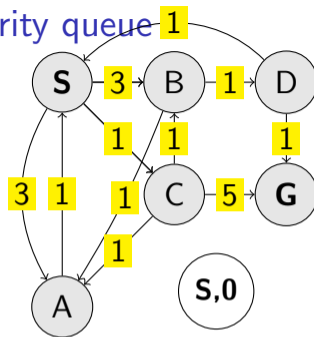

Q: (-, S, 0)  
visited: S

# Uniform Cost Search (Dijkstra), Q is priority queue

```
1: function FORWARD_SEARCH
2:   Q.insert(., s0, 0) and mark s0 as visited
3:   while Q not empty do
4:     p, s, _ ← Q.pop_first()
5:     parent[s] ← p
6:     if s ∈ SG then return Success
7:     for all a ∈ A(s) do
8:       s', c ← result(s, a)           ▷ c cost
9:       if s' not visited then
10:        Mark s' as visited
11:        Q.insert(s, s', cost_from_start)
12:       else
13:        Resolve duplicate s'
return Failure
```

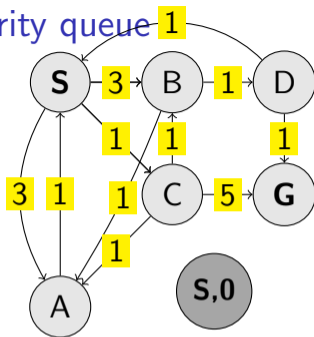

Q:  
visited: S

# Uniform Cost Search (Dijkstra), Q is priority queue

```
1: function FORWARD_SEARCH
2:   Q.insert(., s0, 0) and mark s0 as visited
3:   while Q not empty do
4:     p, s, _ ← Q.pop_first()
5:     parent[s] ← p
6:     if s ∈ SG then return Success
7:     for all a ∈ A(s) do
8:       s', c ← result(s, a)
9:       if s' not visited then
10:        Mark s' as visited
11:        Q.insert(s, s', cost_from_start)
12:     else
13:       Resolve duplicate s'
return Failure
```

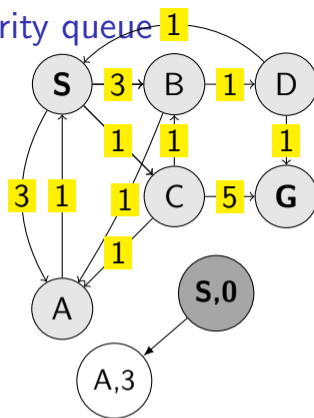

Q:  
visited: S

# Uniform Cost Search (Dijkstra), Q is priority queue

```
1: function FORWARD_SEARCH
2:   Q.insert(., s0, 0) and mark s0 as visited
3:   while Q not empty do
4:     p, s, _ ← Q.pop_first()
5:     parent[s] ← p
6:     if s ∈ SG then return Success
7:     for all a ∈ A(s) do
8:       s', c ← result(s, a)
9:       if s' not visited then
10:        Mark s' as visited
11:        Q.insert(s, s', cost_from_start)
12:     else
13:       Resolve duplicate s'
return Failure
```

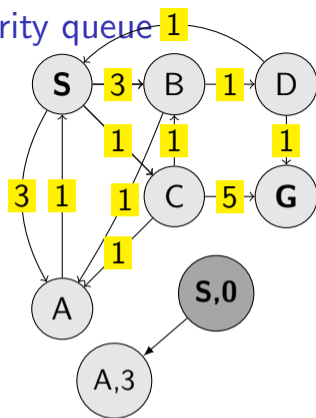

Q: (S,A,3)  
visited: S A

# Uniform Cost Search (Dijkstra), Q is priority queue

```
1: function FORWARD_SEARCH
2:   Q.insert(., s0, 0) and mark s0 as visited
3:   while Q not empty do
4:     p, s, _ ← Q.pop_first()
5:     parent[s] ← p
6:     if s ∈ SG then return Success
7:     for all a ∈ A(s) do
8:       s', c ← result(s, a)
9:       if s' not visited then
10:        Mark s' as visited
11:        Q.insert(s, s', cost_from_start)
12:     else
13:       Resolve duplicate s'
return Failure
```

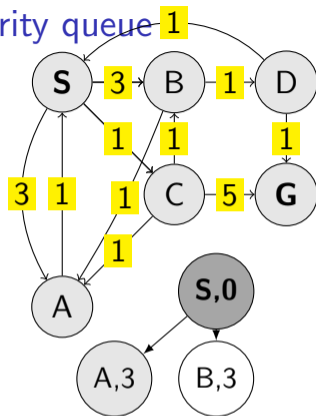

Q: (S,A,3)  
visited: S A



# Uniform Cost Search (Dijkstra), Q is priority queue

```
1: function FORWARD_SEARCH
2:   Q.insert(., s0, 0) and mark s0 as visited
3:   while Q not empty do
4:     p, s, _ ← Q.pop_first()
5:     parent[s] ← p
6:     if s ∈ SG then return Success
7:     for all a ∈ A(s) do
8:       s', c ← result(s, a)
9:       if s' not visited then
10:         Mark s' as visited
11:         Q.insert(s, s', cost_from_start)
12:       else
13:         Resolve duplicate s'
return Failure
```

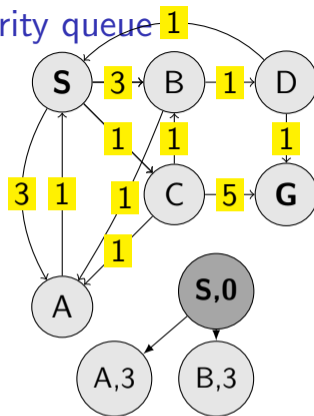

▷ c cost

Q: (S,A,3) (S,B,3)  
visited: S A B

# Uniform Cost Search (Dijkstra), Q is priority queue

```

1: function FORWARD_SEARCH
2:   Q.insert(., s0, 0) and mark s0 as visited
3:   while Q not empty do
4:     p, s, _ ← Q.pop_first()
5:     parent[s] ← p
6:     if s ∈ SG then return Success
7:     for all a ∈ A(s) do
8:       s', c ← result(s, a)
9:       if s' not visited then
10:        Mark s' as visited
11:        Q.insert(s, s', cost_from_start)
12:     else
13:       Resolve duplicate s'
return Failure
  
```

▷ c cost

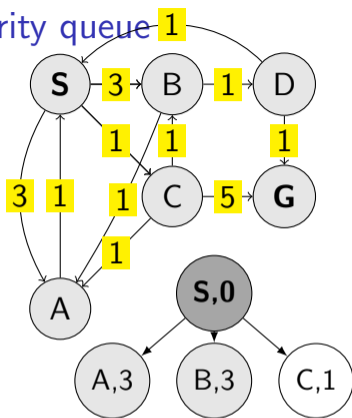

Q: (S,A,3) (S,B,3)  
 visited: S A B

# Uniform Cost Search (Dijkstra), Q is priority queue

```

1: function FORWARD_SEARCH
2:   Q.insert(., s0, 0) and mark s0 as visited
3:   while Q not empty do
4:     p, s, _ ← Q.pop_first()
5:     parent[s] ← p
6:     if s ∈ SG then return Success
7:     for all a ∈ A(s) do
8:       s', c ← result(s, a)
9:       if s' not visited then
10:        Mark s' as visited
11:        Q.insert(s, s', cost_from_start)
12:     else
13:       Resolve duplicate s'
return Failure
  
```

▷ c cost

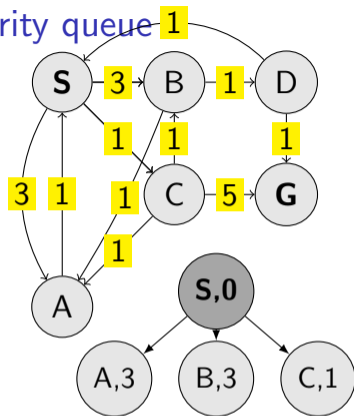

Q: (S,C,1) (S,A,3) (S,B,3)  
 visited: **S** A B C

# Uniform Cost Search (Dijkstra), Q is priority queue

```
1: function FORWARD_SEARCH
2:   Q.insert(., s0, 0) and mark s0 as visited
3:   while Q not empty do
4:     p, s, _ ← Q.pop_first()
5:     parent[s] ← p
6:     if s ∈ SG then return Success
7:     for all a ∈ A(s) do
8:       s', c ← result(s, a)
9:       if s' not visited then
10:        Mark s' as visited
11:        Q.insert(s, s', cost_from_start)
12:     else
13:       Resolve duplicate s'
return Failure
```

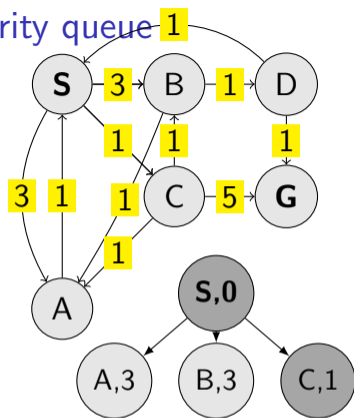

Q: (S,A,3) (S,B,3)  
visited: S A B C

# Uniform Cost Search (Dijkstra), Q is priority queue

```
1: function FORWARD_SEARCH
2:   Q.insert(., s0, 0) and mark s0 as visited
3:   while Q not empty do
4:     p, s, _ ← Q.pop_first()
5:     parent[s] ← p
6:     if s ∈ SG then return Success
7:     for all a ∈ A(s) do
8:       s', c ← result(s, a)
9:       if s' not visited then
10:        Mark s' as visited
11:        Q.insert(s, s', cost_from_start)
12:     else
13:       Resolve duplicate s'
return Failure
```

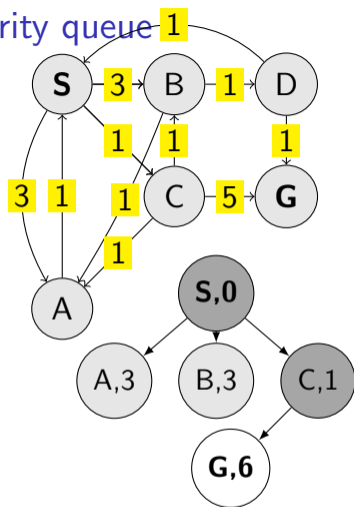

Q: (S,A,3) (S,B,3)  
visited: S A B C

# Uniform Cost Search (Dijkstra), Q is priority queue

```
1: function FORWARD_SEARCH
2:   Q.insert(., s0, 0) and mark s0 as visited
3:   while Q not empty do
4:     p, s, _ ← Q.pop_first()
5:     parent[s] ← p
6:     if s ∈ SG then return Success
7:     for all a ∈ A(s) do
8:       s', c ← result(s, a)
9:       if s' not visited then
10:        Mark s' as visited
11:        Q.insert(s, s', cost_from_start)
12:     else
13:       Resolve duplicate s'
return Failure
```

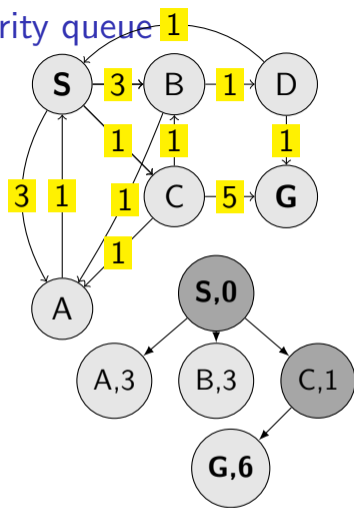

▷ c cost

Q: (S,A,3) (S,B,3) (C,G,6)  
visited: **S** A B C **G**

# Uniform Cost Search (Dijkstra), Q is priority queue

```

1: function FORWARD_SEARCH
2:   Q.insert(., s0, 0) and mark s0 as visited
3:   while Q not empty do
4:     p, s, _ ← Q.pop_first()
5:     parent[s] ← p
6:     if s ∈ SG then return Success
7:     for all a ∈ A(s) do
8:       s', c ← result(s, a)
9:       if s' not visited then
10:        Mark s' as visited
11:        Q.insert(s, s', cost_from_start)
12:     else
13:       Resolve duplicate s'
return Failure
  
```

▷ c cost

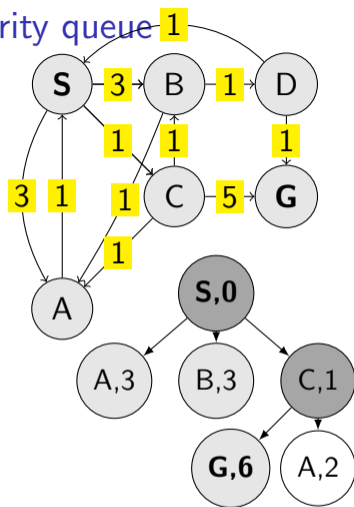

Q: (S,A,3) (S,B,3) (C,G,6)  
 visited: **S A B C G**

# Uniform Cost Search (Dijkstra), Q is priority queue

```

1: function FORWARD_SEARCH
2:   Q.insert(., s0, 0) and mark s0 as visited
3:   while Q not empty do
4:     p, s, _ ← Q.pop_first()
5:     parent[s] ← p
6:     if s ∈ SG then return Success
7:     for all a ∈ A(s) do
8:       s', c ← result(s, a)
9:       if s' not visited then
10:        Mark s' as visited
11:        Q.insert(s, s', cost_from_start)
12:     else
13:       Resolve duplicate s'
return Failure
  
```

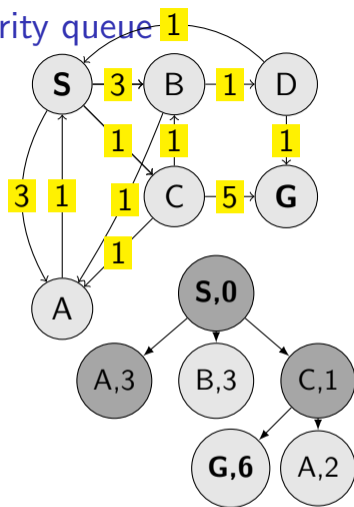

▷ c cost

Q: (C,A,2) (S,B,3) (C,G,6)  
 visited: **S** A B C G



# Uniform Cost Search (Dijkstra), Q is priority queue

```

1: function FORWARD_SEARCH
2:   Q.insert(., s0, 0) and mark s0 as visited
3:   while Q not empty do
4:     p, s, _ ← Q.pop_first()
5:     parent[s] ← p
6:     if s ∈ SG then return Success
7:     for all a ∈ A(s) do
8:       s', c ← result(s, a)
9:       if s' not visited then
10:        Mark s' as visited
11:        Q.insert(s, s', cost_from_start)
12:     else
13:       Resolve duplicate s'
return Failure
  
```

▷ c cost

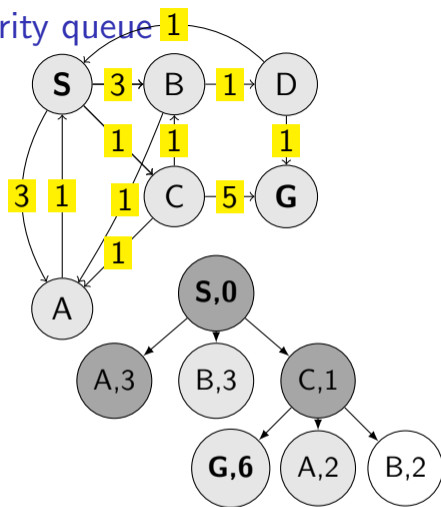

Q: (C,A,2) (S,B,3) (C,G,6)  
 visited: **S A B C G**

# Uniform Cost Search (Dijkstra), Q is priority queue

```

1: function FORWARD_SEARCH
2:   Q.insert(., s0, 0) and mark s0 as visited
3:   while Q not empty do
4:     p, s, _ ← Q.pop_first()
5:     parent[s] ← p
6:     if s ∈ SG then return Success
7:     for all a ∈ A(s) do
8:       s', c ← result(s, a)
9:       if s' not visited then
10:        Mark s' as visited
11:        Q.insert(s, s', cost_from_start)
12:     else
13:       Resolve duplicate s'
return Failure
  
```

▷ c cost

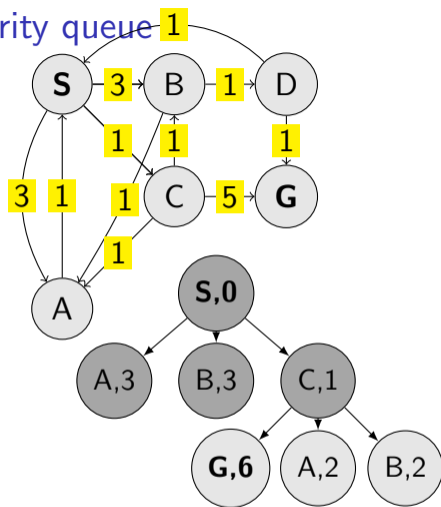

Q: (C,A,2) (C,B,2) (C,G,6)  
 visited: **S A B C G**

# Uniform Cost Search (Dijkstra), Q is priority queue

```

1: function FORWARD_SEARCH
2:   Q.insert(., s0, 0) and mark s0 as visited
3:   while Q not empty do
4:     p, s, _ ← Q.pop_first()
5:     parent[s] ← p
6:     if s ∈ SG then return Success
7:     for all a ∈ A(s) do
8:       s', c ← result(s, a)
9:       if s' not visited then
10:        Mark s' as visited
11:        Q.insert(s, s', cost_from_start)
12:     else
13:       Resolve duplicate s'
return Failure
  
```

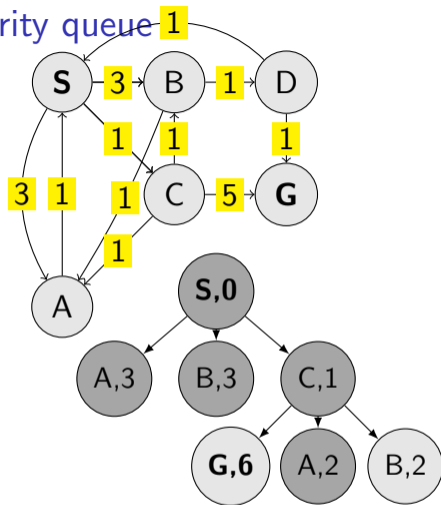

▷ c cost

Q: (C,B,2) (C,G,6)  
 visited: S A B C G

# Uniform Cost Search (Dijkstra), Q is priority queue

```

1: function FORWARD_SEARCH
2:   Q.insert(., s0, 0) and mark s0 as visited
3:   while Q not empty do
4:     p, s, _ ← Q.pop_first()
5:     parent[s] ← p
6:     if s ∈ SG then return Success
7:     for all a ∈ A(s) do
8:       s', c ← result(s, a)
9:       if s' not visited then
10:        Mark s' as visited
11:        Q.insert(s, s', cost_from_start)
12:     else
13:       Resolve duplicate s'
return Failure
  
```

▷ c cost

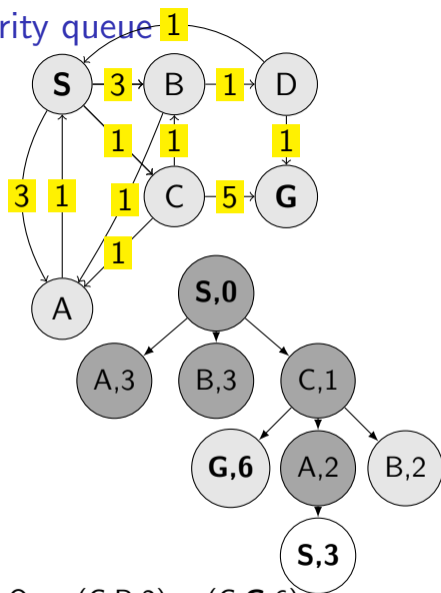

Q: (C,B,2) (C,G,6)  
 visited: S A B C G

# Uniform Cost Search (Dijkstra), Q is priority queue

```

1: function FORWARD_SEARCH
2:   Q.insert(., s0, 0) and mark s0 as visited
3:   while Q not empty do
4:     p, s, _ ← Q.pop_first()
5:     parent[s] ← p
6:     if s ∈ SG then return Success
7:     for all a ∈ A(s) do
8:       s', c ← result(s, a)
9:       if s' not visited then
10:        Mark s' as visited
11:        Q.insert(s, s', cost_from_start)
12:     else
13:       Resolve duplicate s'
return Failure
  
```

▷ c cost

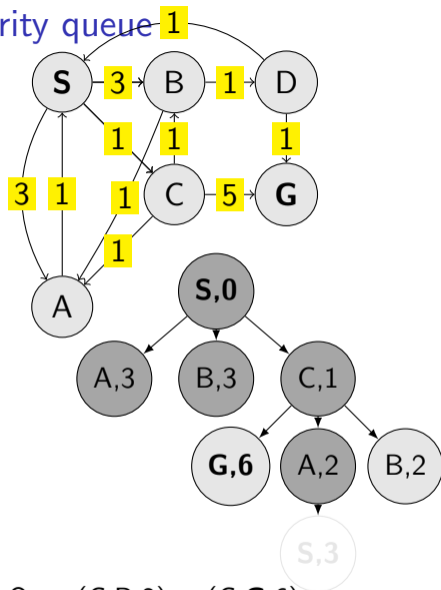

Q: (C,B,2) (C,G,6)  
 visited: **S A B C G**

# Uniform Cost Search (Dijkstra), Q is priority queue

```
1: function FORWARD_SEARCH
2:   Q.insert(., s0, 0) and mark s0 as visited
3:   while Q not empty do
4:     p, s, _ ← Q.pop_first()
5:     parent[s] ← p
6:     if s ∈ SG then return Success
7:     for all a ∈ A(s) do
8:       s', c ← result(s, a)
9:       if s' not visited then
10:        Mark s' as visited
11:        Q.insert(s, s', cost_from_start)
12:     else
13:       Resolve duplicate s'
```

**return** Failure

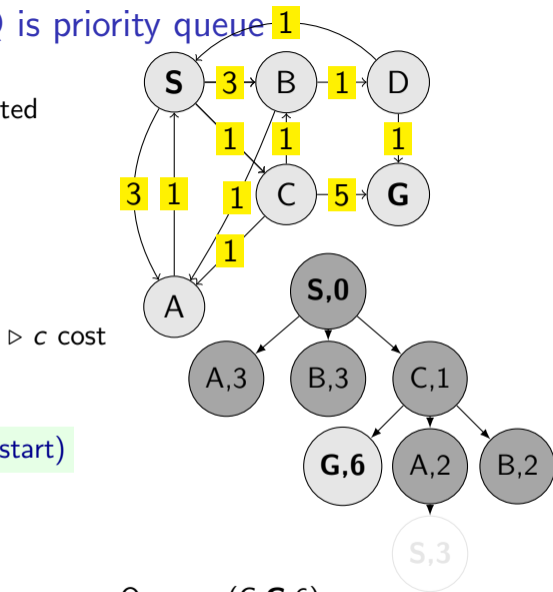

Q: (C,G,6)  
visited: S A B C G

# Uniform Cost Search (Dijkstra), Q is priority queue

```

1: function FORWARD_SEARCH
2:   Q.insert(., s0, 0) and mark s0 as visited
3:   while Q not empty do
4:     p, s, _ ← Q.pop_first()
5:     parent[s] ← p
6:     if s ∈ SG then return Success
7:     for all a ∈ A(s) do
8:       s', c ← result(s, a)
9:       if s' not visited then
10:        Mark s' as visited
11:        Q.insert(s, s', cost_from_start)
12:     else
13:       Resolve duplicate s'
return Failure
  
```

▷ c cost

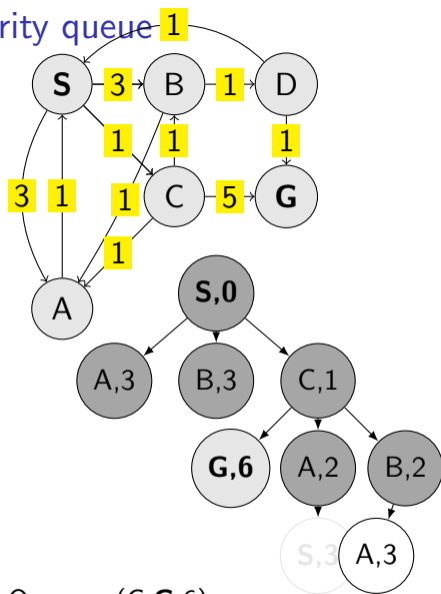

Q: (C,G,6)  
 visited: **S A B C G**

# Uniform Cost Search (Dijkstra), Q is priority queue

```

1: function FORWARD_SEARCH
2:   Q.insert(., s0, 0) and mark s0 as visited
3:   while Q not empty do
4:     p, s, _ ← Q.pop_first()
5:     parent[s] ← p
6:     if s ∈ SG then return Success
7:     for all a ∈ A(s) do
8:       s', c ← result(s, a)
9:       if s' not visited then
10:        Mark s' as visited
11:        Q.insert(s, s', cost_from_start)
12:     else
13:       Resolve duplicate s'
return Failure
  
```

▷ c cost

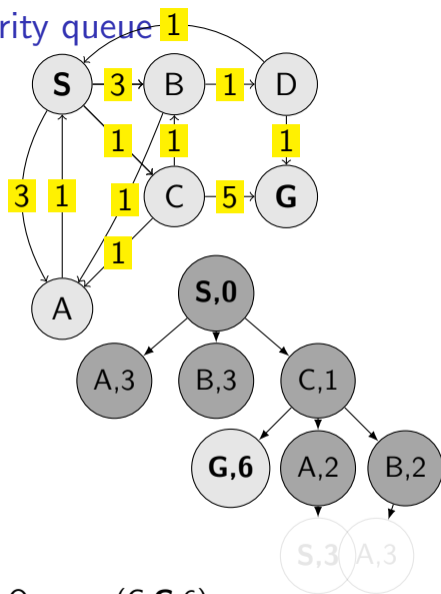

Q: (C, G, 6)  
 visited: S A B C G



# Uniform Cost Search (Dijkstra), Q is priority queue

```

1: function FORWARD_SEARCH
2:   Q.insert(., s0, 0) and mark s0 as visited
3:   while Q not empty do
4:     p, s, _ ← Q.pop_first()
5:     parent[s] ← p
6:     if s ∈ SG then return Success
7:     for all a ∈ A(s) do
8:       s', c ← result(s, a)
9:       if s' not visited then
10:        Mark s' as visited
11:        Q.insert(s, s', cost_from_start)
12:     else
13:       Resolve duplicate s'
return Failure
  
```

▷ c cost

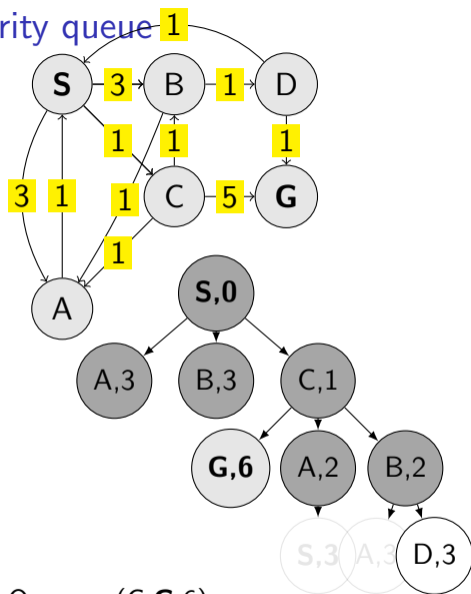

Q: (C, G, 6)  
 visited: S A B C G

# Uniform Cost Search (Dijkstra), Q is priority queue

```

1: function FORWARD_SEARCH
2:   Q.insert(., s0, 0) and mark s0 as visited
3:   while Q not empty do
4:     p, s, _ ← Q.pop_first()
5:     parent[s] ← p
6:     if s ∈ SG then return Success
7:     for all a ∈ A(s) do
8:       s', c ← result(s, a)
9:       if s' not visited then
10:        Mark s' as visited
11:        Q.insert(s, s', cost_from_start)
12:     else
13:       Resolve duplicate s'
return Failure
  
```

▷ c cost

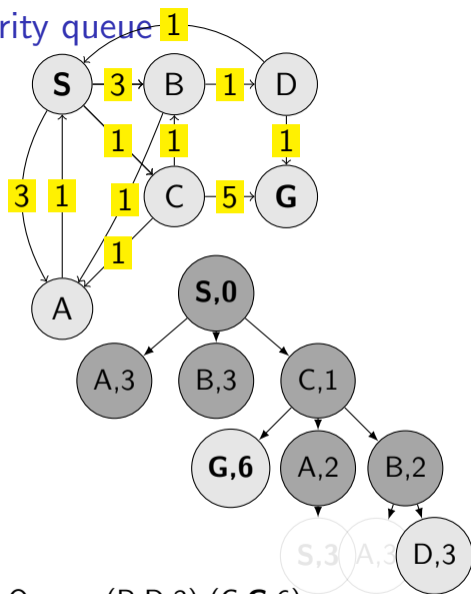

Q: (B,D,3) (C,G,6)  
 visited: S A B C G D

# Uniform Cost Search (Dijkstra), Q is priority queue

```

1: function FORWARD_SEARCH
2:   Q.insert(., s0, 0) and mark s0 as visited
3:   while Q not empty do
4:     p, s, _ ← Q.pop_first()
5:     parent[s] ← p
6:     if s ∈ SG then return Success
7:     for all a ∈ A(s) do
8:       s', c ← result(s, a)
9:       if s' not visited then
10:        Mark s' as visited
11:        Q.insert(s, s', cost_from_start)
12:     else
13:       Resolve duplicate s'
return Failure
  
```

▷ c cost

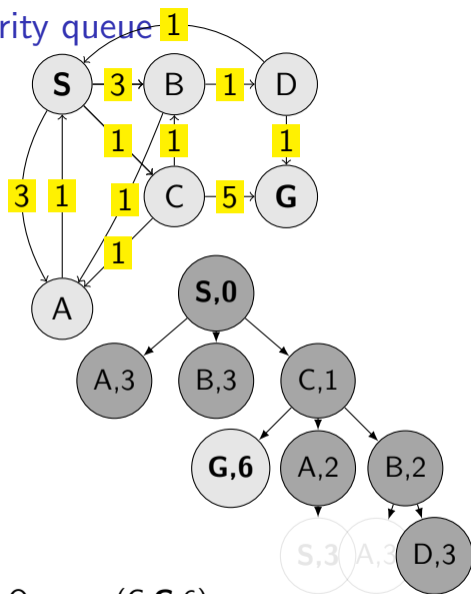

Q: (C, G, 6)  
 visited: S A B C G D

# Uniform Cost Search (Dijkstra), Q is priority queue

```

1: function FORWARD_SEARCH
2:   Q.insert(., s0, 0) and mark s0 as visited
3:   while Q not empty do
4:     p, s, _ ← Q.pop_first()
5:     parent[s] ← p
6:     if s ∈ SG then return Success
7:     for all a ∈ A(s) do
8:       s', c ← result(s, a)
9:       if s' not visited then
10:        Mark s' as visited
11:        Q.insert(s, s', cost_from_start)
12:     else
13:       Resolve duplicate s'
return Failure
  
```

▷ c cost

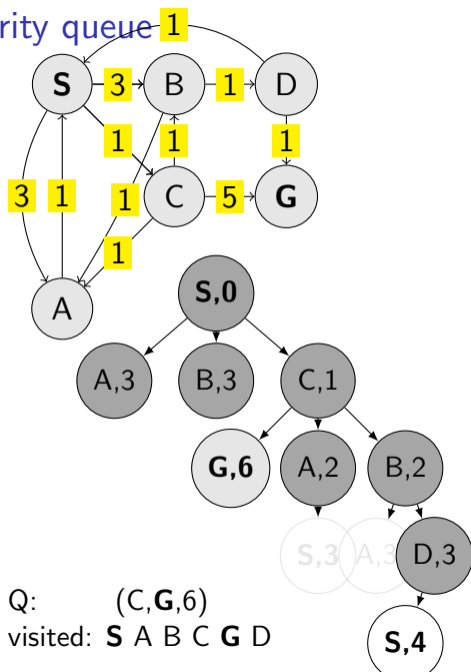

# Uniform Cost Search (Dijkstra), Q is priority queue

```

1: function FORWARD_SEARCH
2:   Q.insert(., s0, 0) and mark s0 as visited
3:   while Q not empty do
4:     p, s, _ ← Q.pop_first()
5:     parent[s] ← p
6:     if s ∈ SG then return Success
7:     for all a ∈ A(s) do
8:       s', c ← result(s, a)
9:       if s' not visited then
10:        Mark s' as visited
11:        Q.insert(s, s', cost_from_start)
12:     else
13:       Resolve duplicate s'
return Failure
  
```

▷ c cost

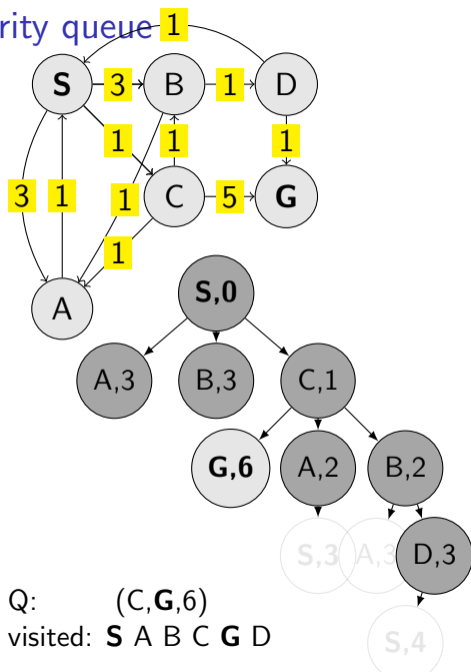

# Uniform Cost Search (Dijkstra), Q is priority queue

```

1: function FORWARD_SEARCH
2:   Q.insert(., s0, 0) and mark s0 as visited
3:   while Q not empty do
4:     p, s, _ ← Q.pop_first()
5:     parent[s] ← p
6:     if s ∈ SG then return Success
7:     for all a ∈ A(s) do
8:       s', c ← result(s, a)
9:       if s' not visited then
10:        Mark s' as visited
11:        Q.insert(s, s', cost_from_start)
12:     else
13:       Resolve duplicate s'
return Failure
  
```

▷ c cost

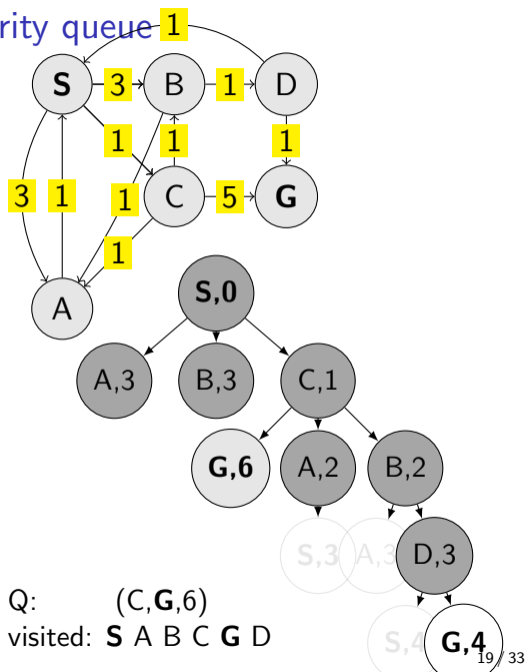

# Uniform Cost Search (Dijkstra), Q is priority queue

```

1: function FORWARD_SEARCH
2:   Q.insert(., s0, 0) and mark s0 as visited
3:   while Q not empty do
4:     p, s, _ ← Q.pop_first()
5:     parent[s] ← p
6:     if s ∈ SG then return Success
7:     for all a ∈ A(s) do
8:       s', c ← result(s, a)
9:       if s' not visited then
10:        Mark s' as visited
11:        Q.insert(s, s', cost_from_start)
12:     else
13:       Resolve duplicate s'
return Failure
  
```

▷ c cost

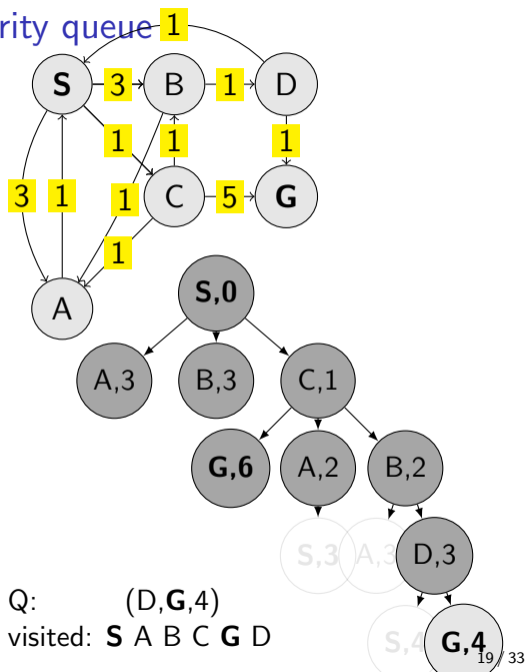

# Uniform Cost Search (Dijkstra), Q is priority queue

```

1: function FORWARD_SEARCH
2:   Q.insert(., s0, 0) and mark s0 as visited
3:   while Q not empty do
4:     p, s, _ ← Q.pop_first()
5:     parent[s] ← p
6:     if s ∈ SG then return Success
7:     for all a ∈ A(s) do
8:       s', c ← result(s, a)
9:       if s' not visited then
10:        Mark s' as visited
11:        Q.insert(s, s', cost_from_start)
12:     else
13:       Resolve duplicate s'
return Failure
  
```

▷ c cost

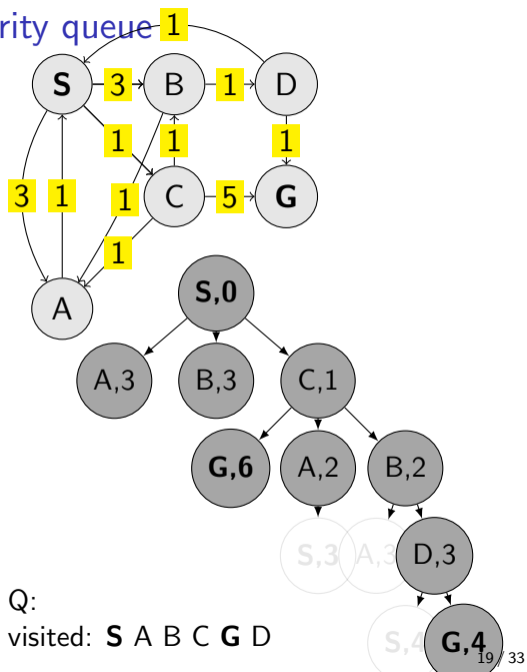



# UCS properties

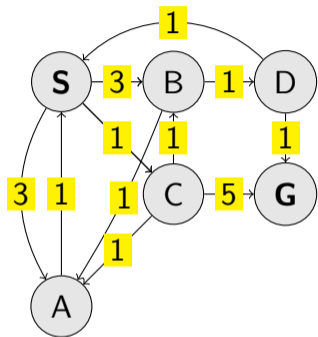

Complete?

Optimal?

Complexities?

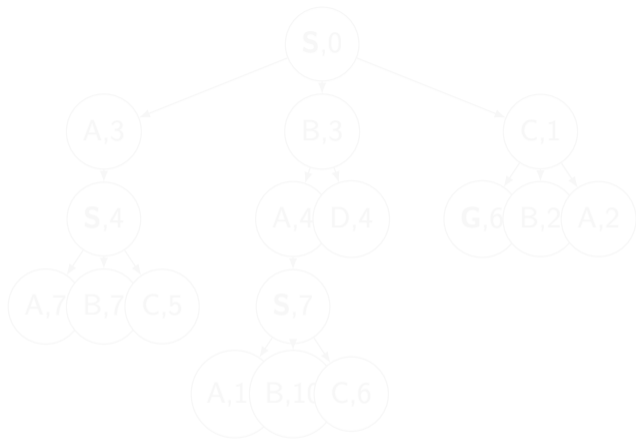

# UCS properties

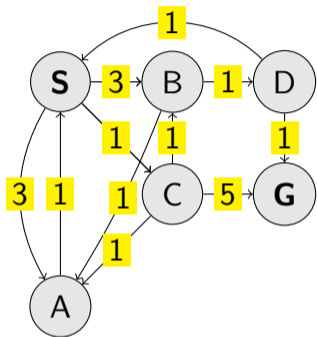

Complete?

Optimal?

Complexities?

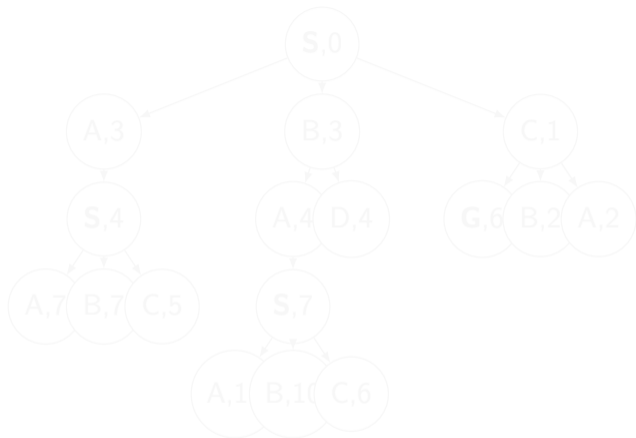

# UCS properties

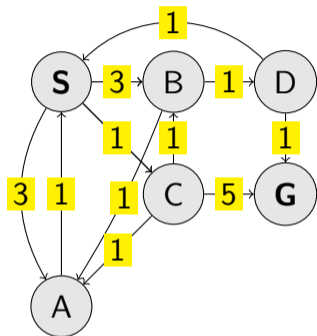

Complete?  
Optimal?  
Complexities?

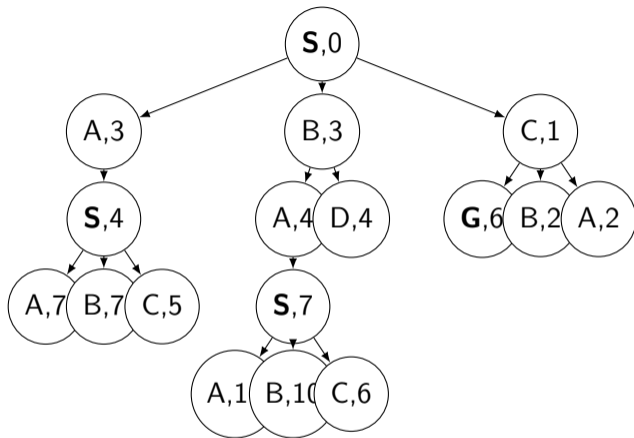

Node selection, take  $\operatorname{argmin} f(n)$ . Search Node:  $n = (p, s, \text{cost\_value})$

Selecting next node to explore (pop operation):

$$\text{node} \leftarrow \operatorname{argmin}_{n \in Q} f(n)$$

What is  $f(n)$  for DFS, BFS, and UCS?

- ▶ DFS:  $f(n) = n.\text{cost\_from\_start}$
- ▶ BFS:  $f(n) = n.\text{depth}$
- ▶ UCS:  $f(n) = -n.\text{depth}$

The good: (one) frontier as a priority queue  
(I.e., priority queue will work universally. Still, stack (LIFO) and queue (FIFO) are (conceptually) the perfect data structures for DFS and BFS, respectively.)

The bad: All the  $f(n)$  correspond to the accumulated cost from start to  $n$ ,  $\text{cost\_from\_start}$ .

Node selection, take  $\operatorname{argmin} f(n)$ . Search Node:  $n = (p, s, \text{cost\_value})$

Selecting next node to explore (pop operation):

$$\text{node} \leftarrow \operatorname{argmin}_{n \in Q} f(n)$$

What is  $f(n)$  for DFS, BFS, and UCS?

- ▶ DFS:  $f(n) = n.\text{cost\_from\_start}$
- ▶ BFS:  $f(n) = n.\text{depth}$
- ▶ UCS:  $f(n) = -n.\text{depth}$

The good: (one) frontier as a priority queue  
(i.e., priority queue will work universally. Still, stack (LIFO) and queue (FIFO) are  
(conceptually) the perfect data structures for DFS and BFS, respectively.)

The bad: All the  $f(n)$  correspond to the accumulated cost from start to  $n$ ,  $\text{cost\_from\_start}$ .

Node selection, take  $\operatorname{argmin} f(n)$ . Search Node:  $n = (p, s, \text{cost\_value})$

Selecting next node to explore (pop operation):

$$\text{node} \leftarrow \operatorname{argmin}_{n \in Q} f(n)$$

What is  $f(n)$  for DFS, BFS, and UCS?

- ▶ DFS:  $f(n) = n.\text{cost\_from\_start}$
- ▶ BFS:  $f(n) = n.\text{depth}$
- ▶ UCS:  $f(n) = -n.\text{depth}$

The good: (one) frontier as a priority queue  
(I.e., priority queue will work universally. Still, stack (LIFO) and queue (FIFO) are (conceptually) the perfect data structures for DFS and BFS, respectively.)

The bad: All the  $f(n)$  correspond to the accumulated cost from start to  $n$ ,  $\text{cost\_from\_start}$ .

Node selection, take  $\operatorname{argmin} f(n)$ . Search Node:  $n = (p, s, \text{cost\_value})$

Selecting next node to explore (pop operation):

$$\text{node} \leftarrow \operatorname{argmin}_{n \in Q} f(n)$$

What is  $f(n)$  for DFS, BFS, and UCS?

- ▶ DFS:  $f(n) = n.\text{cost\_from\_start}$
- ▶ BFS:  $f(n) = n.\text{depth}$
- ▶ UCS:  $f(n) = -n.\text{depth}$

The good: (one) frontier as a priority queue  
(I.e., priority queue will work universally. Still, stack (LIFO) and queue (FIFO) are (conceptually) the perfect data structures for DFS and BFS, respectively.)

The bad: All the  $f(n)$  correspond to the accumulated cost from start to  $n$ , `cost_from_start`.

## How far are we from the goal **cost-to-go** ? – Heuristics

- ▶ A function that estimates how close a *state* is to the goal.
- ▶ Designed for a particular problem.
- ▶  $h(s)$  – it is function of the state (attribute of the search node)
- ▶ It is often shortened as  $h(n)$  – heuristic value of node  $n$ .



# Example of heuristics

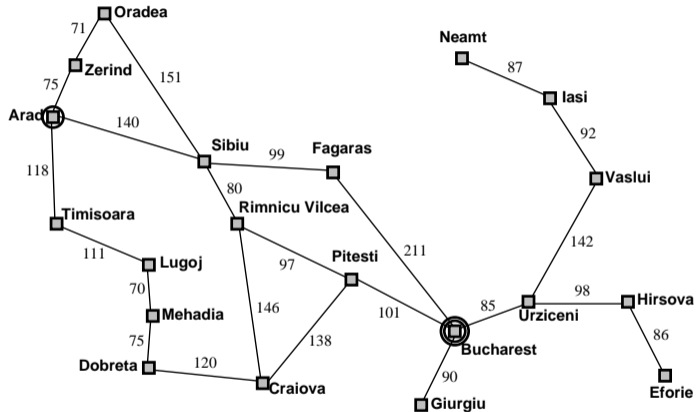

Arad	366	Mehadia	241
Bucharest	0	Neamt	234
Craiova	160	Oradea	380
Drobeta	242	Pitesti	100
Eforie	161	Rimnicu Vilcea	193
Fagaras	176	Sibiu	253
Giurgiu	77	Timisoara	329
Hirsova	151	Urziceni	80
Iasi	226	Vaslui	199
Lugoj	244	Zerind	374

Greedy, take the  $n^* = \operatorname{argmin}_{n \in Q} h(n)$

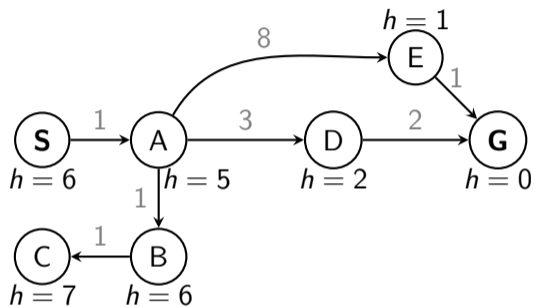

What is wrong (and nice) with the Greedy?

Greedy, take the  $n^* = \operatorname{argmin}_{n \in Q} h(n)$

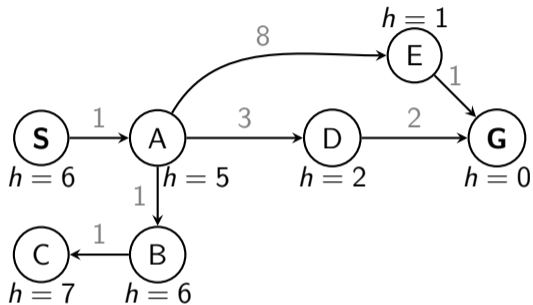

What is wrong (and nice) with the Greedy?

## A\* combines UCS and Greedy

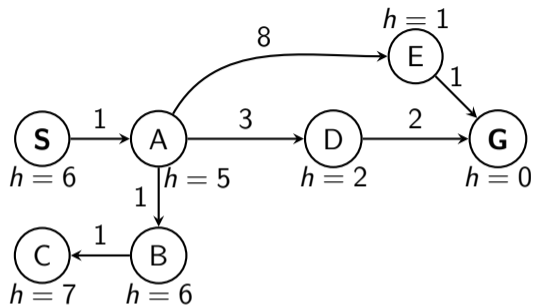

UCS orders by backward (path) cost  $g(n)$

Greedy uses heuristics (goal proximity)  $h(n)$

A\* orders nodes by:  $f(n) = g(n) + h(n)$

## A\* combines UCS and Greedy

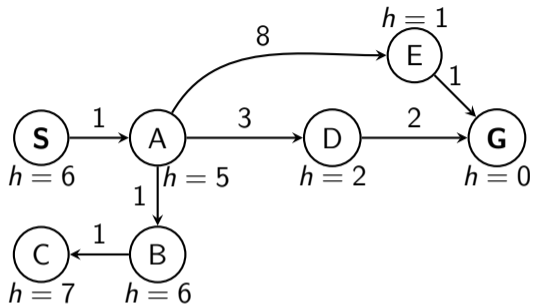

UCS orders by backward (path) cost  $g(n)$

Greedy uses heuristics (goal proximity)  $h(n)$

A\* orders nodes by:  $f(n) = g(n) + h(n)$

Is  $A^*$  optimal?

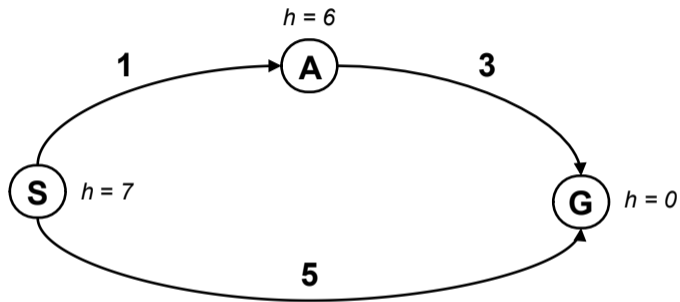

2

What is the problem?

---

<sup>2</sup>Graph example: Dan Klein and Pieter Abbeel

Is  $A^*$  optimal?

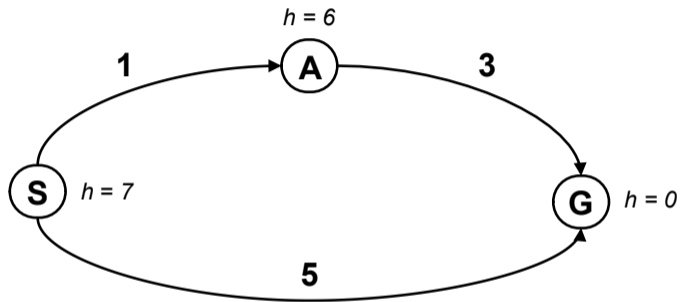

2

What is the problem?

---

<sup>2</sup>Graph example: Dan Klein and Pieter Abbeel

What is the right  $h(A)$ ?

A:  $0 \leq h(A) \leq 4$

B:  $h(A) \leq 3$

C:  $0 \leq h(A) \leq 3$

D:  $0 \leq h(A)$

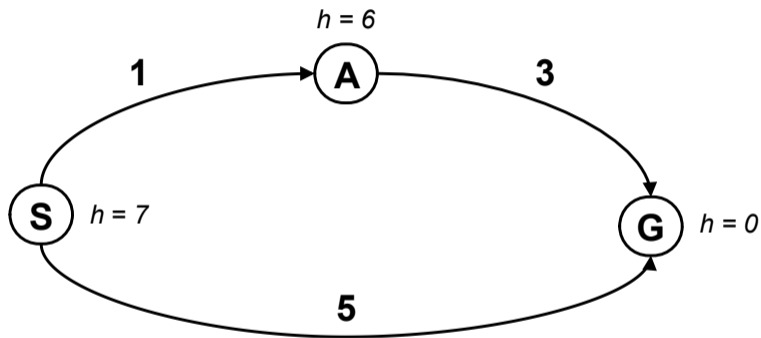



## Admissible heuristics

A heuristic function  $h$  is admissible if:

$$\begin{aligned}h(n) &\leq \text{cost}(n.\text{state}, \text{Goal}_{\text{nearest}}) \\h(\text{Goal}) &= 0\end{aligned}$$

## Consistent heuristic

```
1: function FORWARD_SEARCH
2:   Q.insert(., s0, 0) and mark s0 visited
3:   while Q not empty do
4:     p, s, _ ← Q.pop()
5:     parent[s] ← p
6:     if s ∈ SG then return Success
7:     for all a ∈ A(s) do
8:       s', c ← result(s, a)
9:       if s' not visited then
10:        Mark s' as visited
11:        Q.insert(s, s', cost_from_start + h(s'))
12:       else
13:        Resolve duplicate s'
return Failure
```

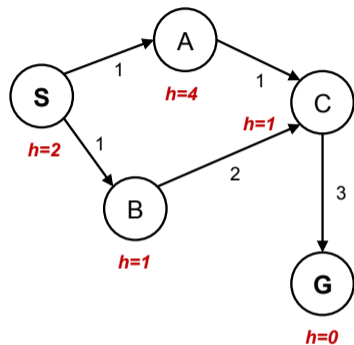

S,2

## Consistent heuristic

```
1: function FORWARD_SEARCH
2:   Q.insert(., s0, 0) and mark s0 visited
3:   while Q not empty do
4:     p, s, _ ← Q.pop()
5:     parent[s] ← p
6:     if s ∈ SG then return Success
7:     for all a ∈ A(s) do
8:       s', c ← result(s, a)
9:       if s' not visited then
10:        Mark s' as visited
11:        Q.insert(s, s', cost_from_start + h(s'))
12:       else
13:        Resolve duplicate s'
return Failure
```

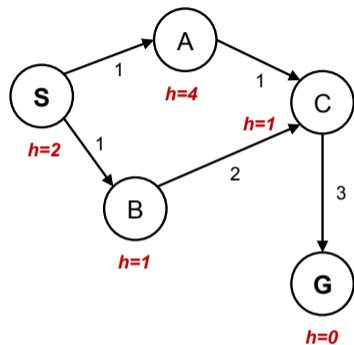

S,2

## Consistent heuristic

```
1: function FORWARD_SEARCH
2:   Q.insert(., s0, 0) and mark s0 visited
3:   while Q not empty do
4:     p, s, _ ← Q.pop()
5:     parent[s] ← p
6:     if s ∈ SG then return Success
7:     for all a ∈ A(s) do
8:       s', c ← result(s, a)
9:       if s' not visited then
10:        Mark s' as visited
11:        Q.insert(s, s', cost_from_start + h(s'))
12:       else
13:        Resolve duplicate s'
return Failure
```

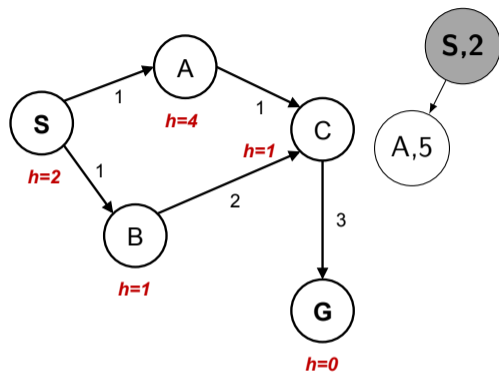

## Consistent heuristic

```
1: function FORWARD_SEARCH
2:   Q.insert(., s0, 0) and mark s0 visited
3:   while Q not empty do
4:     p, s, _ ← Q.pop()
5:     parent[s] ← p
6:     if s ∈ SG then return Success
7:     for all a ∈ A(s) do
8:       s', c ← result(s, a)
9:       if s' not visited then
10:        Mark s' as visited
11:        Q.insert(s, s', cost_from_start + h(s'))
12:       else
13:        Resolve duplicate s'
return Failure
```

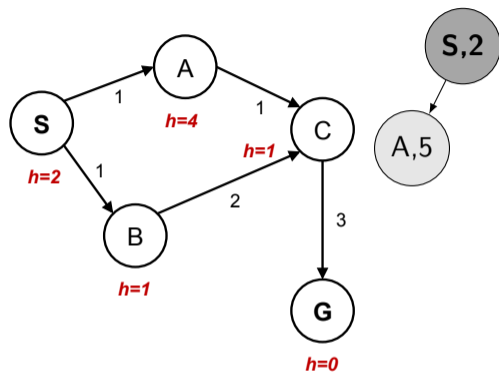

## Consistent heuristic

```
1: function FORWARD_SEARCH
2:   Q.insert(., s0, 0) and mark s0 visited
3:   while Q not empty do
4:     p, s, _ ← Q.pop()
5:     parent[s] ← p
6:     if s ∈ SG then return Success
7:     for all a ∈ A(s) do
8:       s', c ← result(s, a)
9:       if s' not visited then
10:        Mark s' as visited
11:        Q.insert(s, s', cost_from_start + h(s'))
12:       else
13:        Resolve duplicate s'
return Failure
```

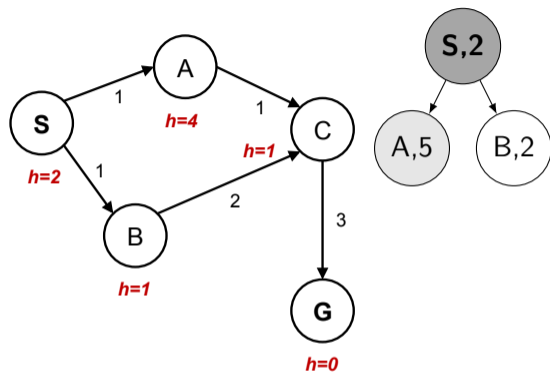

## Consistent heuristic

```
1: function FORWARD_SEARCH
2:   Q.insert(., s0, 0) and mark s0 visited
3:   while Q not empty do
4:     p, s, _ ← Q.pop()
5:     parent[s] ← p
6:     if s ∈ SG then return Success
7:     for all a ∈ A(s) do
8:       s', c ← result(s, a)
9:       if s' not visited then
10:        Mark s' as visited
11:        Q.insert(s, s', cost_from_start + h(s'))
12:       else
13:        Resolve duplicate s'
return Failure
```

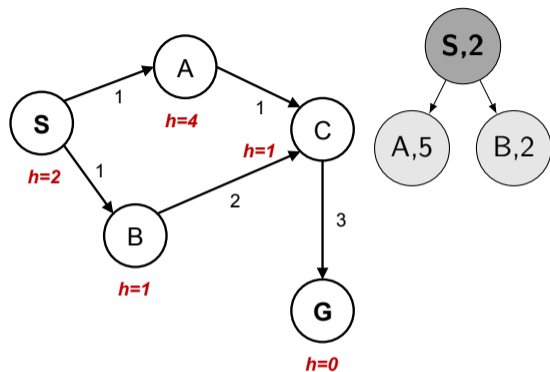

## Consistent heuristic

```
1: function FORWARD_SEARCH
2:   Q.insert(., s0, 0) and mark s0 visited
3:   while Q not empty do
4:     p, s, _ ← Q.pop()
5:     parent[s] ← p
6:     if s ∈ SG then return Success
7:     for all a ∈ A(s) do
8:       s', c ← result(s, a)
9:       if s' not visited then
10:        Mark s' as visited
11:        Q.insert(s, s', cost_from_start + h(s'))
12:       else
13:        Resolve duplicate s'
return Failure
```

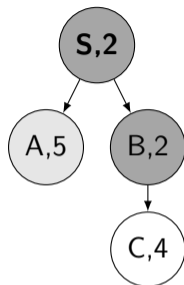
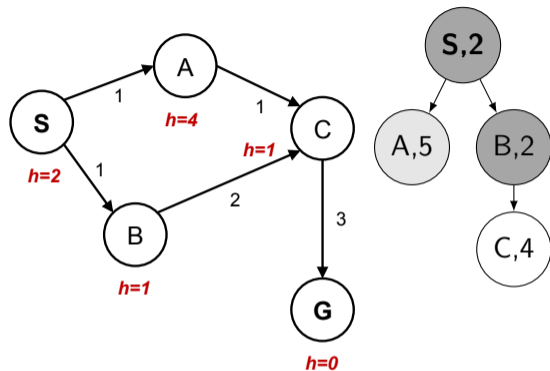



## Consistent heuristic

```
1: function FORWARD_SEARCH
2:   Q.insert(., s0, 0) and mark s0 visited
3:   while Q not empty do
4:     p, s, _ ← Q.pop()
5:     parent[s] ← p
6:     if s ∈ SG then return Success
7:     for all a ∈ A(s) do
8:       s', c ← result(s, a)
9:       if s' not visited then
10:        Mark s' as visited
11:        Q.insert(s, s', cost_from_start + h(s'))
12:       else
13:        Resolve duplicate s'
return Failure
```

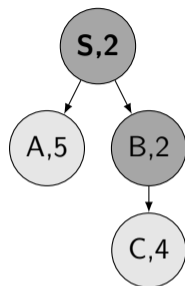
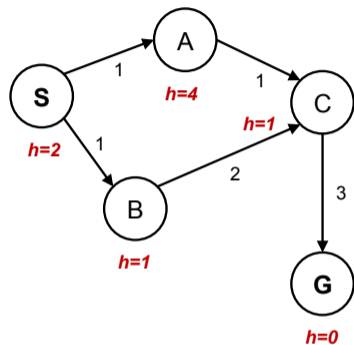

## Consistent heuristic

```
1: function FORWARD_SEARCH
2:   Q.insert(., s0, 0) and mark s0 visited
3:   while Q not empty do
4:     p, s, _ ← Q.pop()
5:     parent[s] ← p
6:     if s ∈ SG then return Success
7:     for all a ∈ A(s) do
8:       s', c ← result(s, a)
9:       if s' not visited then
10:        Mark s' as visited
11:        Q.insert(s, s', cost_from_start + h(s'))
12:       else
13:        Resolve duplicate s'
return Failure
```

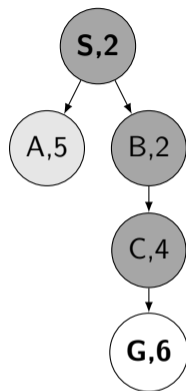
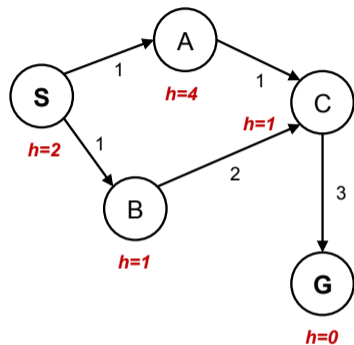

## Consistent heuristic

```
1: function FORWARD_SEARCH
2:   Q.insert(., s0, 0) and mark s0 visited
3:   while Q not empty do
4:     p, s, _ ← Q.pop()
5:     parent[s] ← p
6:     if s ∈ SG then return Success
7:     for all a ∈ A(s) do
8:       s', c ← result(s, a)
9:       if s' not visited then
10:        Mark s' as visited
11:        Q.insert(s, s', cost_from_start + h(s'))
12:       else
13:        Resolve duplicate s'
return Failure
```

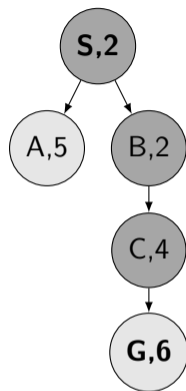
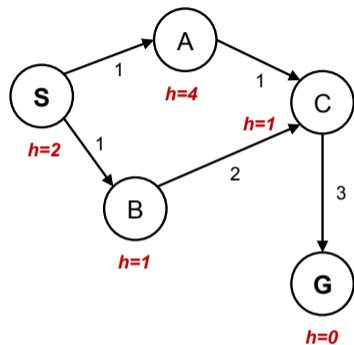

## Consistent heuristic

```
1: function FORWARD_SEARCH
2:   Q.insert(., s0, 0) and mark s0 visited
3:   while Q not empty do
4:     p, s, _ ← Q.pop()
5:     parent[s] ← p
6:     if s ∈ SG then return Success
7:     for all a ∈ A(s) do
8:       s', c ← result(s, a)
9:       if s' not visited then
10:        Mark s' as visited
11:        Q.insert(s, s', cost_from_start + h(s'))
12:       else
13:        Resolve duplicate s'
return Failure
```

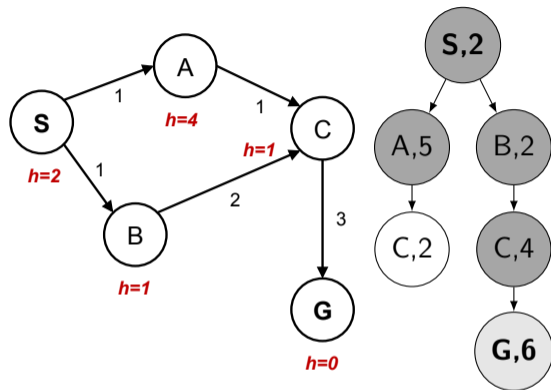

## Consistent heuristic

```
1: function FORWARD_SEARCH
2:   Q.insert(., s0, 0) and mark s0 visited
3:   while Q not empty do
4:     p, s, _ ← Q.pop()
5:     parent[s] ← p
6:     if s ∈ SG then return Success
7:     for all a ∈ A(s) do
8:       s', c ← result(s, a)
9:       if s' not visited then
10:        Mark s' as visited
11:        Q.insert(s, s', cost_from_start + h(s'))
12:       else
13:        Resolve duplicate s'
return Failure
```

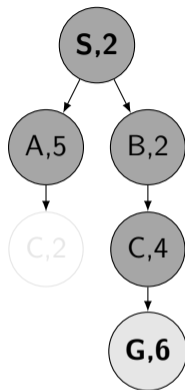
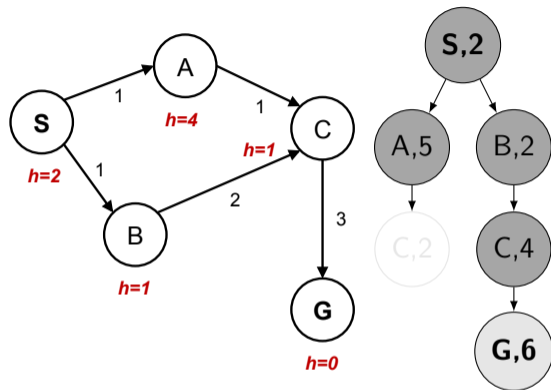

## What would be the proper $h(A)$ ?

Consider other  $h(s)$  fixed.

A:  $h(A) = 1$

B:  $h(A) = 2$

C:  $1 \leq h(A) \leq 2$

D:  $0 \leq h(A) \leq 1$

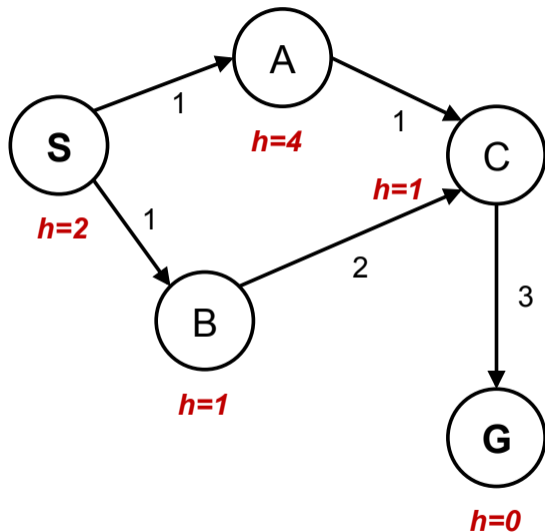

## Consistent heuristics

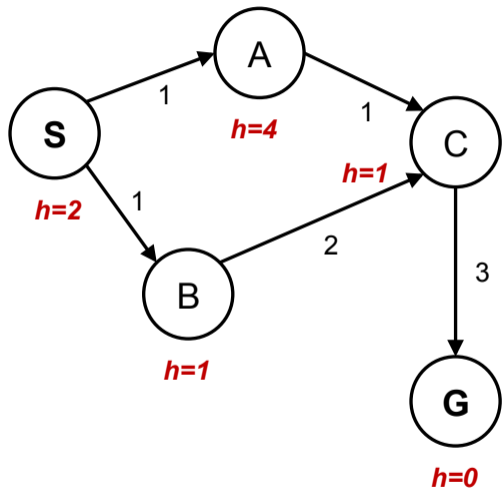

Admissible  $h$ :

$$h(A) \leq \text{true cost } A \rightarrow G$$

Consistent  $h$ :

$$h(A) - h(C) \leq \text{true cost } A \rightarrow C$$

in general:

$$h(p) - h(s) \leq \text{true cost } p \rightarrow s \text{ for any pair:}$$

parent  $p$  and its successor  $s$

$f(n) = g(n) + h(n)$  along a path never decreases!

## Consistent heuristics

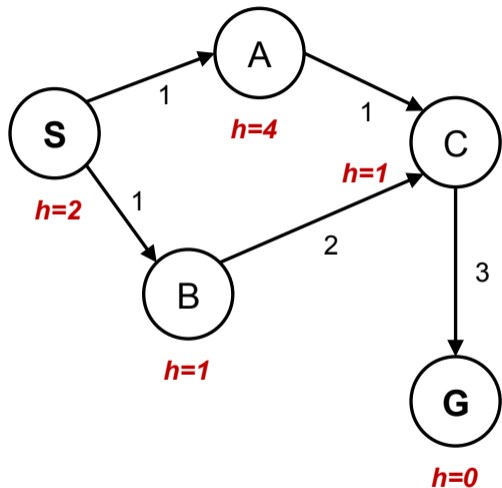

Admissible  $h$ :

$$h(A) \leq \text{true cost } A \rightarrow G$$

Consistent  $h$ :

$$h(A) - h(C) \leq \text{true cost } A \rightarrow C$$

in general:

$$h(p) - h(s) \leq \text{true cost } p \rightarrow s \text{ for any pair:}$$

parent  $p$  and its successor  $s$

$f(n) = g(n) + h(n)$  along a path never decreases!



## Consistent heuristics

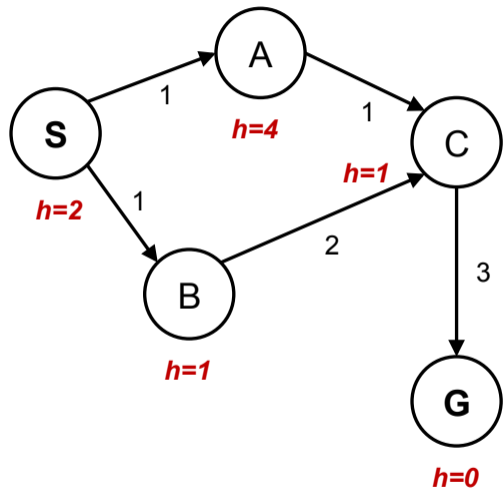

Admissible  $h$ :

$$h(A) \leq \text{true cost } A \rightarrow G$$

Consistent  $h$ :

$$h(A) - h(C) \leq \text{true cost } A \rightarrow C$$

in general:

$$h(p) - h(s) \leq \text{true cost } p \rightarrow s \text{ for any pair:}$$

parent  $p$  and its successor  $s$

$f(n) = g(n) + h(n)$  along a path never decreases!

## Consistent heuristics

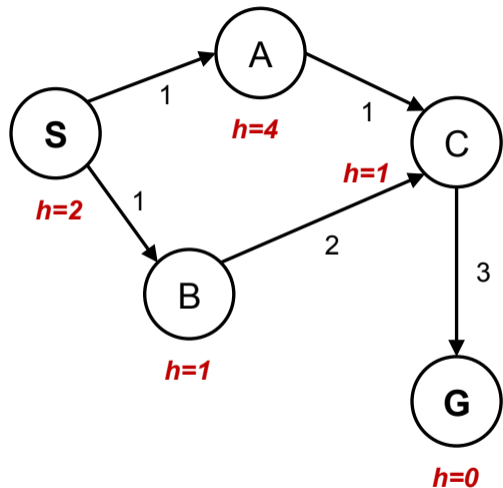

Admissible  $h$ :

$$h(A) \leq \text{true cost } A \rightarrow G$$

Consistent  $h$ :

$$h(A) - h(C) \leq \text{true cost } A \rightarrow C$$

in general:

$$h(p) - h(s) \leq \text{true cost } p \rightarrow s \text{ for any pair:}$$

parent  $p$  and its successor  $s$

$f(n) = g(n) + h(n)$  along a path never decreases!

# Summary

- ▶ Effectiveness – adding heuristic estimates of cost-to-go
- ▶ Not all heuristics are equally good (admissibility, consistence, informativeness)

## References, further reading

Some figures from [2]. Chapter 2 in [1] provides a compact/dense intro into search algorithms.

[1] Steven M. LaValle.

*Planning Algorithms.*

Cambridge, 1st edition, 2006.

Online version available at: <http://planning.cs.uiuc.edu>.

[2] Stuart Russell and Peter Norvig.

*Artificial Intelligence: A Modern Approach.*

Prentice Hall, 4th edition, 2021.

<http://aima.cs.berkeley.edu/>.