



BTL-08Lx ECG Series

USER'S MANUAL

CONTENTS

1	GENERAL CHARACTERISTICS	4
2	INSTRUCTIONS FOR USE	5
2.1	Outward Appearance	5
2.1.1	Top Panel of the Equipment	5
2.1.2	Keyboard	6
2.1.3	Rear Panel of the Equipment	6
2.2	Assembly and Putting into Operation	7
2.3	Functions of the Keyboard Buttons	7
2.3.1	auto	7
2.3.2	man	7
2.3.3	profile.....	8
2.3.4	print	8
2.3.5	stop.....	8
2.3.6	analyse	8
2.3.7	copy	8
2.3.8	1mV	8
2.3.9	restart	8
2.3.10	number of leads.....	8
2.3.11	select leads	8
2.3.12	mm/s.....	9
2.3.13	mm/mV	9
2.3.14	filter	9
2.3.15	drift	9
2.3.16	monitor leads	9
2.3.17	patient.....	9
2.3.18	menu	9
2.3.19	mode	10
2.3.20	print screen.....	10
2.3.21	contrast.....	10
2.3.22	esc.....	10
2.3.23	enter	10
2.3.24	up / down arrow	10
2.3.25	on/off	10
2.3.26	form feed (FF)	10
2.3.27	restart - Restarting and Reset of the Device.....	10
2.4	Check of Loose Leads	11
2.5	Printer and Paper	11
2.5.1	Paper Sensitivity.....	11
2.5.2	Roll ECG Paper	11
2.5.3	Fax Paper without Grid.....	12
2.5.4	Z-folded Paper (perforated).....	12
2.5.5	Printer select	13
2.5.5.1	printer select	13
2.5.5.2	resolution(dpi)	13
2.5.5.3	printer test.....	13
2.5.6	Storage Conditions for Thermo-Sensitive Paper	13
2.6	Accumulator	14
2.7	Lithium Battery	14
3	EXAMINATION	15
3.1	"On Line" Mode	15
3.2	Selection of Profile for ECG Recording	15
3.3	Position of Electrodes	15
3.3.1	Limb Electrodes	16
3.3.2	Chest Electrodes	16
3.4	Examination Process	16
3.4.1	Examination in the Automat Profile	16
3.4.2	Examination in the Manual Profile	17
3.4.3	Examination in the Print Screen Profile	17
3.4.4	Examination in the User Profiles	17
3.4.5	Examination in the Long Profile.....	17
3.5	Reliability of Measuring and Diagnostics.....	17

3.6	Use of Filters	18
4	SETUP MODE	21
4.1	Main Menu	21
4.1.1	Record Database	21
4.1.2	Unit Setup.....	21
4.1.2.1	Starting Profile	21
4.1.2.2	Max. Heart Rate.....	22
4.1.2.3	QRS Acoustic Signal	22
4.1.2.4	Rhythm Lead	22
4.1.2.5	Line Width.....	22
4.1.2.6	Patient Card Setup	22
4.1.2.7	Optional Patient Data.....	22
4.1.2.8	Setting of Paper and Print.....	22
4.1.2.9	Export Setup	22
4.1.2.9.1	Transfer: Serial Cable->BTL08	22
4.1.2.9.2	Transfer: Modem->BTL08	23
4.1.2.9.3	Transfer: USB->BTL08.....	24
4.1.2.10	User Setup.....	25
4.1.2.10.1	Date / Time.....	25
4.1.2.10.2	Display Contrast.....	25
4.1.2.10.3	Select Language	25
4.1.2.10.4	Touch Panel Calibration.....	26
4.1.2.10.5	Repair of Files	26
4.1.2.10.6	File System Formatting	26
4.1.2.10.7	Default Setting - No User Data Loss	26
4.1.2.10.8	Sleep Mode Interval	26
4.1.2.10.9	Battery Status Indication	26
4.1.2.10.10	Demo	26
4.1.2.10.11	More.....	26
4.1.2.10.12	Unit Information.....	26
4.1.2.10.13	Information about Filesystem	26
4.1.2.10.14	Setting of Filter 50 Hz / 60 Hz	26
4.1.2.10.15	Setting of HW Key.....	26
4.1.2.10.16	Password Setting	27
4.1.2.10.17	Unlock Code.....	27
4.1.2.10.18	Colour Schemes and Colours of Leads.....	27
4.1.2.10.19	Fast Data Processing.....	27
4.1.2.10.20	Automat Profile Print Speed	27
4.1.3	Profile Setup	27
4.1.3.1	Setting Auto, Man, Print Screen Profile Parameters	27
4.1.3.2	Setting Parameters of Long Type Profiles	28
4.1.4	Select Patient	28
4.1.5	Displayed Leads	28
4.1.6	Select Physician	28
5	ACCESSORIES AND UPGRADE	29
5.1	Accessories.....	29
5.2	Upgrade	29
6	EQUIPMENT MAINTENANCE AND SAFETY	30
6.1	Cleaning of the equipment's surface and of its parts.....	30
6.1.1	Cleaning of the Touch Screen	30
6.1.2	Cleaning of the Paper Sensors.....	30
6.1.3	Cleaning of the Printer Head	31
6.1.4	Cleaning of the Bearings of the Rubber roller.....	31
6.1.5	Cleaning of accessories which come into contact with the patient (e.g. electrodes)	32
6.2	Safety.....	32
6.3	Useful addresses	33
6.4	Warranty	33
7	TECHNICAL PARAMETERS	35

1 GENERAL CHARACTERISTICS

BTL-08Lx ECG Series devices are up-to-date ECG systems for monitoring and recording of resting electrocardiogram. They provide detailed analysis*, diagnostics* and printing of ECG records. The outstanding features including a wide variety of functions and easy operation make the unit an excellent cardiology tool.

BTL-08Lx ECG Series devices are equipped with accumulator batteries that make them fully portable equipment the use of which is not limited to the physician's office.

The assortment of types of the **BTL-08Lx ECG Series** devices include two devices equipped with the graphic display and the 210-mm-wide printer which enables printing of all twelve leads at a time. The devices enable printing also on the ordinary thermo-sensitive "fax" paper which significantly reduces the operational costs. The smaller b/w as well as the larger colour display excel at the quality of displaying and are equipped with touch-panel which enables control directly on the screen. You can select a device that will meet your requirements as perfectly as possible.

BTL-08Lx ECG Series devices stand out with easy and intuitive operation that can be quickly mastered by anyone. ECG recording can start immediately after switch-on of the equipment.

Both types of the **BTL-08Lx ECG Series** devices have a patient database and enable to record and store in the memory many 10-second and longer records from all leads and/or several-minutes-long records from two selected leads – "LONG" type records. The equipment can be also used for ergo metric examinations (in connection with the **BTL-08 Win Ergo** software).

BTL-08Lx ECG Series devices can be also connected to the ergometry equipment which is controlled by the computer with the **BTL-08 Win Ergo** program.

For the latest information about BTL products and contact to BTL companies please visit our website: <http://www.btlnet.com>.

** only if the equipment is upgraded by the Diagnostics software module*

2 INSTRUCTIONS FOR USE

2.1 OUTWARD APPEARANCE

2.1.1 Top Panel of the Equipment

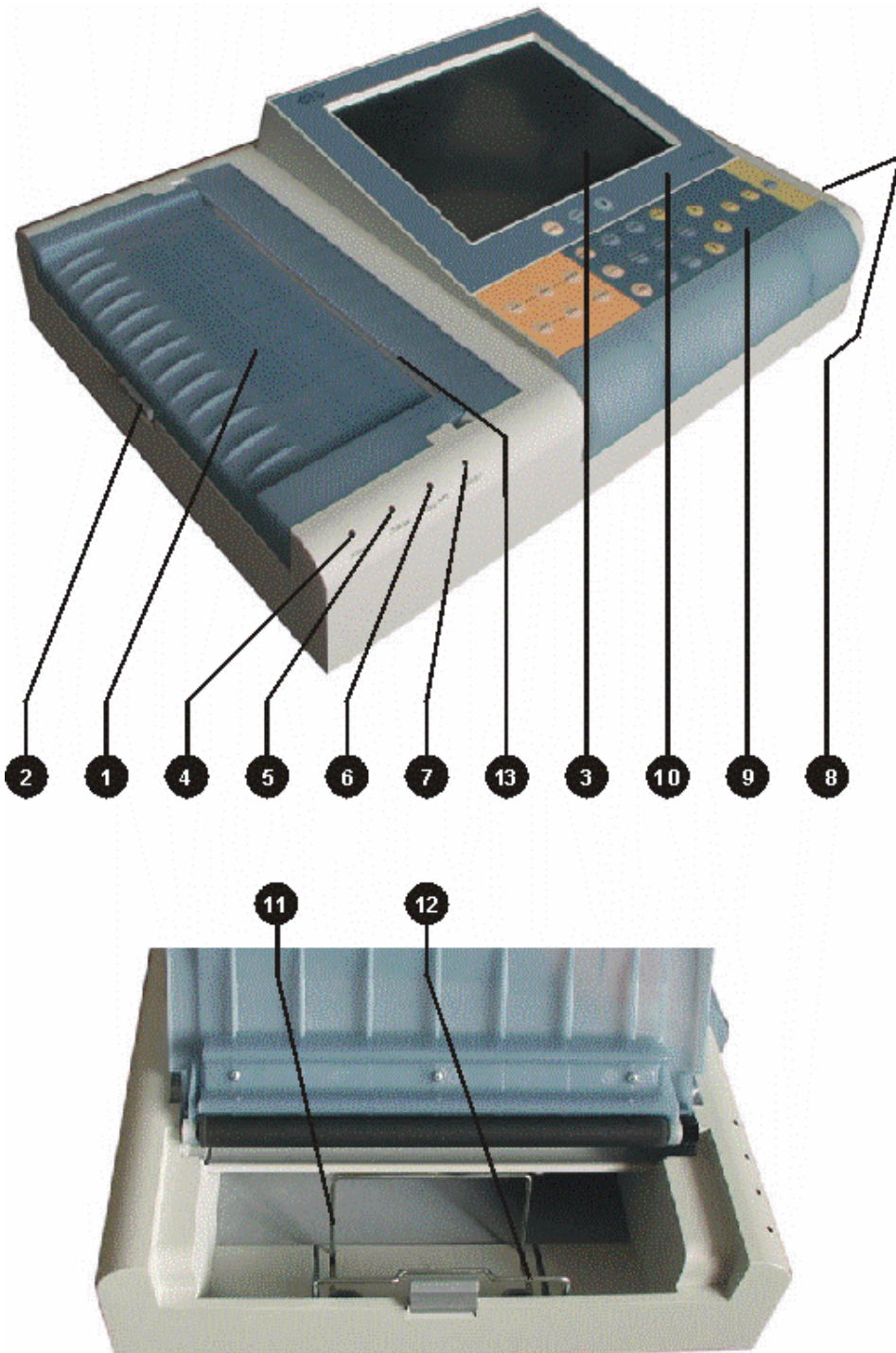

1. printer cover
2. lever for opening the printer
3. touch screen
4. indication of ON status (**power**)
5. indication of charging of accumulators (**charge**)
6. indication of run-down accumulators (**low batt**)
7. indication of printer error (**printer**)
8. connector for the patient cable
9. keyboard for setting of print and record options
10. keyboard for setting of display view
11. holder for the fax paper
12. prop for the Z-folded paper
13. tearing edge for the fax paper

2.1.2 Keyboard

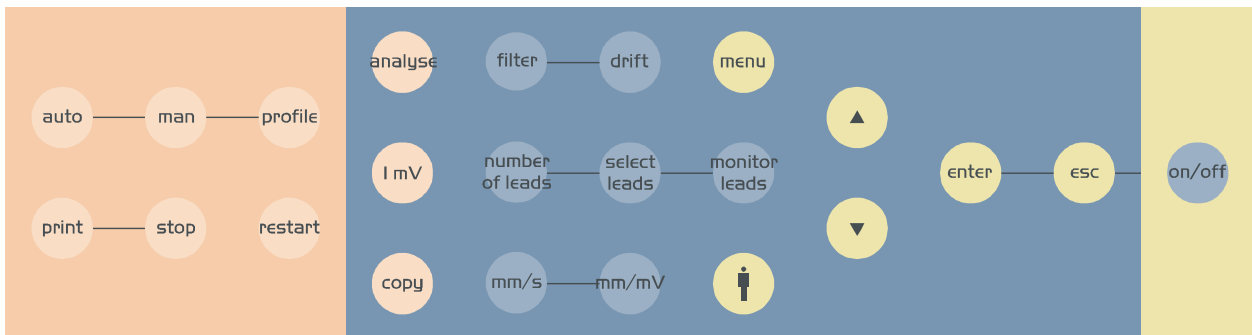

For description of individual buttons see **Functions of the Keyboard Buttons**.

2.1.3 Rear Panel of the Equipment

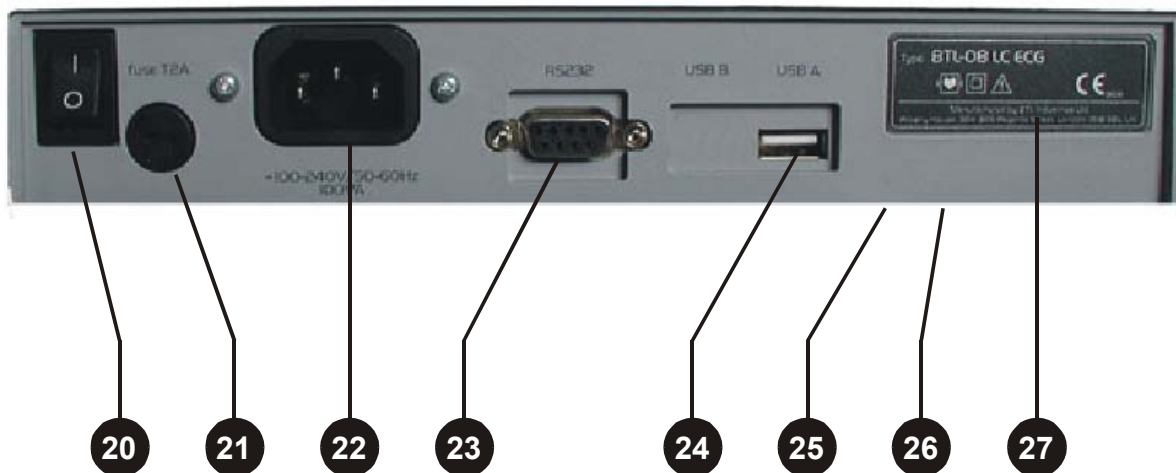

20. power switch – positions 0 / I
21. mains fuse
22. mains cable connector
23. communication connector for connection to PC via the RS232 line
24. connector for connection to PC/printer via USB
25. anti-interference clamp (on the bottom cover of the equipment)
26. type label
27. manufacture and warning label (on the bottom cover of the equipment)

2.2 ASSEMBLY AND PUTTING INTO OPERATION

Unpack the equipment and place it on a stable horizontal surface proportioned for the equipment's weight, out of reach of sunlight. During the operation the equipment gets warm, therefore it must not be located close to heat-producing devices. Cooling of the equipment is provided by forced air circulation. Cooling vents are located at the bottom of the equipment and around the display and must not be covered. Do not put the equipment on a soft surface so as not to obstruct airflow to the bottom cooling vents. Do not put any heat-producing devices on the equipment, neither objects containing water or other liquid. Do not place the equipment close to devices producing strong electromagnetic, electric or magnetic field (diathermy, X-rays, etc.), otherwise the equipment could be undesirably influenced. The ECG paper is heat-sensitive and therefore should be also located out of reach of heat emitters, including sunlight - see **Storage Conditions for Thermo-Sensitive Paper**. In case of any questions please contact the authorized BTL service department.

We recommend keeping the packing of the equipment for further possible transport.

Plug the device directly in the mains socket; do not use any multi-connection extension cable or adapter.

Switching the device on:

Plug the mains cable in the mains socket, switch the **O/ I** rocker switch (**20**) on the rear panel to the **I** position and press the **on/off** switch on the keyboard. The ON status is indicated by the pilot light (**4**).

The mains switch (**20**) should be permanently in the **I** position so that recharging of the accumulators is ensured.

Recharging of accumulator:

The device contains an internal accumulator, which is sold in half-charged status. That is why we recommend formatting of the accumulator after purchase of the device: connect the device to the mains with the **mains rocker switch (20) in position 1** for at least 48 hours without interruption. The device will be recharged and the accumulator will be properly formatted. The properly formatted accumulator enables longer operation of the device without recharging. For details, see **2.6 Accumulator**.

2.3 FUNCTIONS OF THE KEYBOARD BUTTONS

2.3.1 auto

Pressing of the **print** button in this profile starts recording of ECG signal from 12 leads and (for the types, which are equipped with the DIAGNOSTICS software module) it's printing with analysis and verbal interpretation. Print reports depend on the type and settings – for selection use buttons **number of leads** and **select leads**. At the same time, the internal memory of the equipment stores 10 or more seconds of the signal (according to the settings) which can be later printed, analyzed and saved to the patient data – buttons **copy**, **analyse**, **patient**, **menu**. The "auto" profile also enables setting of retrospective printing (the minus time of start of printing), i.e. it is possible to print and save an event which has already passed, up to 10 seconds back in time). To interrupt printings press the **stop** button. This mode is indicated by the word "automat" in the status bar on the display.

The "auto" mode can be also selected directly on the touch screen. After touching the display at any point there appears the top and bottom toolbars. After pressing the **profile** button there appears a menu containing all profiles available in the device.

2.3.2 man

Manual recording of ECG signal from 12 leads. Number of printed leads depends on the settings - for selection use buttons **number of leads** and **select leads**. This mode serves only for direct recording of the ECG signal; the signal

is not recorded in the memory. The print parameters can be selected even during printing. To start printing press the **print** button, to stop printing press **stop**. This mode is indicated by the word "manual" in the status bar on the display.

The "manual" mode can be also selected directly on the touch screen. After touching the display at any point there appears the top and bottom toolbars. After pressing the **profile** button there appears a menu containing all profiles available in the device.

2.3.3 profile

Selection of one of possible user profiles (all profiles except auto, man and print screen - see above) which can be edited in **profile setup**. The highlighting shifts cyclically on the available profiles. Recording is run according to parameters which are preset in the equipment's memory. At the same time, the internal memory of the equipment stores 10 or more seconds of the signal (according to the settings) which can be later printed, analyzed and saved to the patient data – buttons **copy**, **analyse**, **patient**, **menu** (only for profiles derived from the automat type). To interrupt printings press the **stop** button. The current mode is indicated in the bottom status bar on the display.

The profile can be also selected directly on the touch screen. After touching the display at any point there appears the top and bottom toolbars. After pressing the **profile** button there appears a menu containing all profiles available in the device.

2.3.4 print

Press this button to start printing of the record and possibly saving in the memory in the set profile.

2.3.5 stop

Press this button to interrupt the running print. If the device is busy, e.g. by analysis of the signal, the response for pressing the **stop** button may be delayed. In such case wait until the device stops the running operation and then press the button again.

2.3.6 analyse

Button for printing of verbal interpretation and the table with the results of analysis of the last record taken in the **automat** or a derived mode. It is active only if the DIAGNOSTICS module is implemented.

2.3.7 copy

Button for reprinting of the last record taken in the **automat** or a derived mode. Printing is performed with the current values of filters, sensitivity and speed, so, if the values have changed since the last recording in the automat mode, the result of the print may differ from the original. If you need an absolutely identical copy, set the speed, sensitivity and filters the same as in the original and only then press **copy**.

2.3.8 1 mV

Button for printing of the calibration signal of the amplitude 1 mV. The mark is printed only when printing in the **manual** mode.

2.3.9 restart

Button for restarting of ECG inputs and ECG internal amplifiers. Use this button if you are not sure about the quality of the measured ECG record or if the ECG-curves are out of the display.

2.3.10 number of leads

Button for selection of the number of leads to be printed. To select the required combination press this button repeatedly. The current combination is displayed in the top status bar on the display. The resulting setting depends on the currently selected profile, manual or automat.

The number of leads to be printed can be also selected directly on the touch screen. After touching the display at any point there appears the top and bottom toolbars. After pressing the **print** button there appears a screen containing all possible numbers of leads to be printed.

2.3.11 select leads

Button for selection of groups of leads to be printed. The groups of leads cyclically shift when pressing the button. The selected leads are displayed in the top status bar on the display. The function is active only in the **manual** mode and only if less than 12 leads at a time are printed.

2.3.12 m m / s

Button for setting of the paper feed speed. The particular speed values cyclically shift when pressing the button. The current paper speed is displayed in the top status bar on the display.

The paper speed can be also selected directly on the touch screen. After touching the display at any point there appears the top and bottom toolbars. After pressing the **speed** button there appears a screen containing all possible values of the paper speed.

2.3.13 m m / m V

Button for setting of the sensitivity of print. The particular sensitivity values cyclically shift when pressing the button. The current sensitivity value is displayed in the top status bar on the display. Sensitivity can be also changed during printing in the **manual** mode.

Sensitivity can be also selected directly on the touch screen. After touching the display at any point there appears the top and bottom toolbars. After pressing the **sensitivity** touch button there appears a screen containing all possible values of record sensitivity.

2.3.14 filter

Button for setting of mains noise filter, muscular filters and artefact filter. The particular filters or their combinations cyclically shift when pressing the button. The current filter or combination of filters is displayed in the top status bar on the display. It is possible to select the **adaptive auto** filter which on the basis of the signal analysis automatically activates the needed filter so that the quality of the resulting signal is maximum. The **adaptive auto** filter cannot be combined with other filters.

Filters and their combinations can be also selected directly on the touch screen. After touching the display at any point there appears the top and bottom toolbars. After pressing the **filters** button there appears a screen containing all available filters. Here it is possible to activate any filter or combination.

2.3.15 drift

Button for cyclical switching among the base-line filters (**Anti Drift System**). The current filter or combination of filters is displayed in the top status bar on the display. It is possible to select the **adaptive auto** filter which on the basis of the signal analysis automatically activates the needed filter so that the quality of the resulting signal is maximum. The **adaptive auto** filter cannot be combined with other filters.

Filters and their combinations can be also selected directly on the touch screen. After touching the display at any point there appears the top and bottom toolbars. After pressing the **filters** button there appears a screen containing all available filters. Here it is possible to activate any filter or combination.

2.3.16 monitor leads

Button for cyclical switching among the leads displayed on the screen. If the screen displays less than 12 leads at a time, this button enables to switch cyclically to other leads which are not currently displayed. The displaying and number of leads depends on the current display setting (**mode** button).

The leads for displaying can be also switched on the touch screen. After touching the display at any point there appears the top and bottom toolbars. The **monitor leads** button on the screen has the same function as the analogous button on the keyboard.

2.3.17 patient

Button for opening of the dialogue window for entering data of a new patient. To save data press **OK**. These data are printed in the record and stored in the memory together with the record and can be loaded from the database (see **Record Database**) in the menu, viewed and/or printed on the ECG paper. The types of data to be entered and stored can be selected in the unit settings (see **Patient Card Setup**).

2.3.18 menu

Button for activation of the menu containing the unit setup, patient data management, etc.

The menu can be also entered directly from the touch screen. After touching the display at any point there appears the top and bottom toolbars. After pressing the **menu** button (in the lower right corner) there appears a menu as after pressing the keyboard button.

2.3.19 mode

Button for selection of the arrangement of displaying of leads on the display, from 3 leads on the display at a time up to all 12 lead in more columns. All possible variants of displaying rotate on the screen when pressing the button.

The appearance on the display can be also changed in details on the touch screen. After touching the display at any point there appears the top and bottom toolbars. After pressing the **menu** button on the keyboard or on the display the device menu appears which contains the **displayed leads** button. After pressing the button there appears a screen containing all available display combinations including the possibility of assigning a certain lead to a certain window on the display.

2.3.20 print screen

Button for instant printing and saving of the screen status using the special **print screen** profile. This profile serves for capturing of sudden artefacts which the operator spots on the display, therefore recording and printing starts immediately after pressing this button and it is not necessary to start recording by the **print** button. This profile also enables to set retrospective printing (the minus time of the start of printing), i.e. it is possible to print and save an event which has already passed, up to 10 seconds back in time. The profile is configured similarly to the "auto" profile.

2.3.21 contrast

Button for prompt setting of the display contrast. The contrast can be also changed in the equipment settings menu.

Note:

At the colour display, the change of contrast may lead to change of the colour representation of the current colour scheme.

2.3.22 esc

Button for rejection of a selection and/or return to a higher dialogue window in the menu without saving the entered values.

The touch button on the screen, if displayed, has the same function as the keyboard button.

2.3.23 enter

Button for confirmation of a selection and saving of the value and/or for entering the lower window in the menu.

The touch button on the screen, if displayed, has the same function as the keyboard button.

2.3.24 up / down arrow

Buttons for movement in the menu and/or for change of values.

The touch buttons on the screen, if displayed, have the same function as the keyboard buttons.

2.3.25 on/off

Button for switching the device on / off. At switching off, the device checks the status of the accumulators and if it finds them low, it switches to the charging mode; in the charging mode the display is dark and the **power** and **charge** indicators are shining. After recharging of the accumulator the device automatically switches off completely. The charging mode is activated only if the device is plugged in the mains and the mains rocker switch (**20**) on the rear panel is in the **I** position. If the device is not connected or the switch (**20**) is in the **0** position, the device switches off.

Note!

Checking of the accumulator status takes some time, therefore the device may respond with a delay after switching off and then on again.

All saved data remain stored even if power supply is off.

2.3.26 form feed (FF)

This button is available only on the touch screen. After touching the display at any point there appears the top and bottom toolbars. The **FF** ("form feed") button is in the bottom left corner. After pressing this button the paper slightly ejects from the printer, either to the next page (Z-folded paper) or by approx. 3cm (fax paper). The button may be pressed repeatedly. For details on how to work with paper see **Printer and Paper**.

2.3.27 restart - Restarting and Reset of the Device

If for some reason (electromagnetic interference, etc.) the device stops responding to the user's commands (keyboard, touch panel) and the message "please wait..." with small moving squares are not displayed, the device can

be put into the initial state by simultaneous pressing of the **esc** and **restart** buttons. After this action the device immediately restarts. After the restart it is possible to continue the work with the device.

Note:

If the device is in the above-described state ("no response"), the **on/off** button is also disabled. The only help is to reset the device, as described above.

2.4 CHECK OF LOOSE LEADS

If an electrode is wrongly attached to the patient, has bad contact or is not connected, ECG warns of this fact by symbolic texts in the bottom status bar on the display (texts RLFN, V1, V2, V3, V4, V5, and V6). In such case it is recommended to check attachment of the electrodes, press the **restart** button and record the ECG signal only after the equipment stops reporting error.

If you continue recording when the equipment reports a problem on a lead, there may occur considerable distortion of the signal.

Note:

When using the automat profile, the device checks the quality of signal (connection of electrode) before recording, and starts recording only when all electrodes are properly connected. This function can be enabled/disabled in the profile configuration. The individual stages of recording are clearly indicated on the display.

2.5 PRINTER AND PAPER

The used printer prints on thermo-sensitive paper. Quality of the paper may considerably affect quality of the printed ECG-curves. For high-quality printing it is recommended to use only the BTL-recommended paper.

The yellow pilot light (7) indicates printer error status. Possible causes:

- printer is out of paper
- improperly closed printer cover or wrong type of paper or wrongly set type of paper.

At the same time there appears an error message with additional information on the display.

Another way to print with unit is to connect external printer with USB interface. USB connector can be found at rear panel (24) and is designate for both connection, to PC or to printer. Detailed description of how to select printer follows.

2.5.1 Paper Sensitivity

Each type of paper has slightly different sensitivity to thermal impulses produced by the printer. The resulting printout can be too bright and illegible or, on the other hand, too dark or even over burned (over burned print has a white centre in the printed line).

For the above reasons the device is designed so that it adapts to various types of paper. For setting the paper sensitivity use the **paper sensitivity** item in **menu – unit setup – setting of paper and print**. The more sensitive paper is set, the brighter is the resulting printout. There are 5 levels of sensitivity setting available. It is recommended to test the setting on several printouts after any change of the paper type.

2.5.2 Roll ECG Paper

The device can print on the thermo-sensitive fax (=roll) paper with pre-printed grid, nominal width 210 mm (for more detailed specification see Chapter **Technical Parameters**). For high-quality print we recommend exclusive use of paper supplied by the BTL companies. For the fax paper, the paper type must be correctly selected in **menu – unit setup - setting of paper and print - type for fax**. When using the paper with the pre-printed grid it is necessary to disable the **print grid** item on the same screen. If the printer contains another type of paper than set in the unit setup, the device reports an error after a short while of printing.

Inserting paper: Press button (2) to open the printer cover (1). Tilt the fax paper holder (11) towards the printer. Insert the paper roll, the thermo-sensitive layer (grid) facing the printer head (display) so that the paper overlaps the tearing edge (13). Click the printer cover shut. The pilot light (7) indicating that the printer is out of paper stops shining. The printer is ready. To check if the paper is inserted and set correctly check **menu – unit setup - setting of paper and print** after pressing the **insert paper** touch button.

The button for inserting paper or feed to the next page (FF – form feed) is available also in the lower left corner of the on-line screen after touching the screen at any point. By this button you can eject the paper slightly from the printer at any time.

Tearing of paper: It is recommended to tear the fax paper by pulling it from the bottom margin over the tearing edge **13** towards the display.

ATTENTION

It is essential to insert paper carefully and absolutely parallel to the tearing edge (the grid on the paper must be parallel to the tearing edge), otherwise it will later bend to a side and possibly crumple or tear.

2.5.3 Fax Paper without Grid

The device can also print on a standard thermo-sensitive white fax paper without the pre-printed grid, or standard sheet of paper on external printer. In such case it is necessary to enable the **print grid** item in **menu – unit setup - setting of paper and print**. Other settings and handling are the same as for the paper with the pre-printed grid.

ATTENTION

It is essential to insert paper carefully and absolutely parallel to the tearing edge, otherwise it will later bend to a side and possibly crumple or tear.

2.5.4 Z-folded Paper (perforated)

It is also possible to use the thermo-sensitive Z-folded paper with pre-printed grid, nominal width 210 mm (for more detailed specification see Chapter **Technical Parameters**). For high-quality print we recommend exclusive use of paper supplied by the BTL companies. For the Z-folded paper, the paper type must be correctly selected in **menu – unit setup - setting of paper and print** - type **perforated** (Z-folded). At the first use of a new type of Z-folded paper it is necessary to measure some of its dimensions and enter the measured values in the device. The dimensions are: page width of the used paper (C), mark width (B) and distance between the mark and perforation (A). The measured dimensions are indicated in the picture on the screen. The arrow shows in which direction the paper gets out of the device. If the wrong values are set, the device will not eject the paper properly on the perforation which will prevent proper tearing of paper. If paper with the pre-printed grid is used, disable the **print grid** item. If there is inserted another type of paper than set in the unit setup, the device reports an error at the attempt for printing. Never insert more paper sheets in the paper stack than stated in Chapter **Technical Parameters**.

Inserting paper: Press button **(2)** to open the printer cover **(1)**. Tilt the fax paper holder **(11)** away from the printer (display). Insert the Z-folded paper bundle in the paper stack, the thermo-sensitive layer (grid) facing the printer head (display) so that the paper overlaps the tearing edge **(13)**. Click the printer cover shut. The pilot light **(7)** indicating that the printer is out of paper stops shining. The printer is ready. To check if the paper is inserted and set correctly check **menu – unit setup - setting of paper and print** after pressing the **insert paper** touch button (if all dimensions of the paper are set correctly, the paper ejects from the device up to the next perforation. We recommend using this button after each insertion (replacement) of Z-folded paper.

The button for inserting paper or feed to the next page (FF – form feed) is available also in the lower left corner of the on-line screen after touching the screen at any point. By this button you can eject the paper slightly from the printer at any time.

Tearing of paper: We recommend not to tear the Z-folded paper over the tearing edge **13** (which is designed particularly for the fax paper) but over the edge of the printer cover, away from the display. Thus the paper will tear exactly along the perforation and its margin will not be damaged by the tearing edge.

Note:

For easier taking the Z-folded paper out serves the prop **(12)** which enables to lift the bundle up and then takes it in hand and pulls out of the paper stack.

ATTENTION

It is essential to insert paper carefully and absolutely parallel to the tearing edge (the grid on the paper must be parallel to the tearing edge), otherwise it will later bend to a side and possibly crumple or tear.

THE Z-FOLDERED PAPER IS EXTREMELY SENSITIVE TO PROPER INSERTION. IF IT IS INSERTED IMPROPERLY IT CRUMPLES AND TEARS DURING PRINTING.

2.5.5 Printer select

Pressing of **printer select** button open printer select screen, where following items can be found: selection of active printer - **printer select**, resolution used in printing via USB - **resolution (dpi)**, button which is used to print test page on USB printer - **printer test** and information about printer currently connected to unit.

Description of currently connected USB device includes: manufacturer of device, product, supported languages, available memory or maximum resolution supported by printer.

In some cases, when non-printing device or unsupported print device is connected to unit, this information can be unreadable.

Limitations:

- USB print is supported only by units of version 110 and higher (see manufacture label on the bottom cover)
- USB print is supported for firmware version 1.42 and higher, for firmware version see **Unit Information**
- the recommended length of the USB cable is 1,5m.

Printer requirements:

- USB1.1 or USB2.0 interface
- PCL5
- HP compatible DeskJet or LaserJet

ATTENTION

Some printers which is not fully compatible with USB standard, can be unrecognized by unit and cause slow data transmission on USB. Actual version doesn't support model HP LJ 1022.

For actual information on list of compatible printers please contact your distributor.

2.5.5.1 printer select

Press this button to select current output printer. 'USB' means printer connected to USB interface, 'ECG' means internal thermo printer embedded in unit.

For quick view which printer is currently in use, label on bottom-right corner of online screen is displayed. ' – ' means internal printer is selected. 'USB' means external printer is selected.

2.5.5.2 resolution(dpi)

This item is used to change resolution used in USB print. For faster print **200 dpi is recommended**. 300 dpi is dedicated for better quality of printing. Print test page to see which resolution is appropriate for your printer.

2.5.5.3 printer test

For checking right connection or settings, test page can be printed only on USB printer.

Page contains: dimensions for checking of right resolution, used resolution, USB printer description, and unit description.

Compare effective dimensions of printed area with those presented on paper to see if correct resolution is selected.

2.5.6 Storage Conditions for Thermo-Sensitive Paper

The printer is designed for thermo-sensitive paper. To achieve as long as possible time stability of the printout, it is essential to keep the following terms of storage of new as well as of the printed paper:

- storage temperature 25 °C and lower
- relative humidity 65% and lower
- do not expose paper to the sunlight
- do not expose paper to long-lasting radiation of fluorescent sources (tubes, etc.)
- prevent contact of paper with glue based on alcohol, ester, ketone, etc. Use only dispersive glue based on starch, PVA or CMC.

- prevent any direct contact of the paper with PVC packages. These packages contain substances based on ester which would spoil the thermo-sensitive layer and cause vanishing of the record.

2.6 ACCUMULATOR

The type of the accumulator is stated in Chapter **Technical Parameters**. Its replacement is provided by the authorized BTL service department.

During operation the accumulator is continuously being recharged from the mains. Its recharging and keeping charged is running even if the equipment is switched off and connected to mains and the mains switch (20) on the rear panel is in position I. At switching off, the device checks the status of the accumulators and if it finds them low, it switches to the charging mode; in the charging mode the display is dark and the **power** and **charge** pilot lights are shining. After recharging of the accumulator the device automatically switches off completely. Note that the charging process runs only if the device is plugged in the mains and the rocker switch (20) on the rear panel is in the I position.

Checking of the accumulator status may take some time, therefore the device may respond with a delay after switching off and then on again.

For full charging of the accumulator let it recharge for approximately 6 hours – preferably overnight.

A low accumulator is signalled in two levels of signalling.

- the accumulator is low, but it is still possible to print for a short time – the **low batt** indicator (6) is blinking
- the accumulator is dead, the device cannot print – the **low batt** indicator (6) is shining permanently and at the same time there is a warning acoustic signal (short intermittent beeping approx. once every 20 seconds). The acoustic signalling can be disabled, see Chapter **Battery Status Indication**.

During charging of the accumulator the **charge** indicator (5) is shining.

If the "low battery" status is indicated, it is likely that the equipment will not be able to print the entire ECG record. During recording and printing the process may be interrupted. However, the data are still saved in the memory and can be printed after recharging of the accumulator.

To ensure a long lifetime of the accumulator we recommend keeping it permanently charged. When it is possible, connect the ECG to the mains and put the mains switch (20) to the I position. The pilot light (5) will start shining (after recharging it will go out) and the accumulator will be automatically kept in the charged status.

If the device is left unplugged from the mains for a longer time (even in the OFF status), the accumulators gradually spontaneously discharge. This effect is characteristic of the accumulators and cannot be removed; therefore, if the device has been off and unplugged for a longer time than approximately 2-3 months, we recommend recharging it, preferably for 48 hours without interruption.

For the same reason we recommend charging the device continuously for at least 48 hours immediately after purchase, regardless of the accumulator status indication (you can work with the device normally, only do not unplug it from the adapter, the accumulator recharges even during standard operation of the device). Thus the accumulator gets so –called formatted and will keep working longer without recharging.

2.7 LITHIUM BATTERY

The device contains a lithium battery for backup of date and time. The type of the battery is written in Chapter **Technical Parameters**. Its replacement is provided by the authorized BTL service department.

3 EXAMINATION

3.1 "ON LINE" MODE

This mode is automatically started after switch-on of the equipment. The display in this mode displays the recorded ECG signal and the following information:

- the selected print profile (auto, manual, long...)
- heart rate (HR)
- paper speed
- set sensitivity
- set filters
- loose leads, if any
- names of the displayed leads
- number and names of leads to be printed
- ECG-curve
- during saving of a 10-sec-long to 80-sec-long record in the equipment's memory there is displayed description and indicator of the progress
- if the device is busy (e.g. by analysis or interpretation), the display shows the message "please wait...".

After touching the screen in the on-line mode there appear the top and bottom toolbars with buttons serving for setting of parameters, similarly as the keyboard. After approximately 2 seconds without a touch, the toolbars automatically hide.

After switch-on the equipment permanently monitors the input ECG signal and always remembers the last 10 seconds of the signal. This signal can be retrospectively stored and printed in a suitable profile and settings (profile **auto** or **print screen**, item **start time** lower than 0 (0 = start at the moment of pressing the button, -10 = start of printing of the signal 10 seconds before pressing the button)).

3.2 SELECTION OF PROFILE FOR ECG RECORDING

Profiles are pre-set recording and printing parameters that serve for quick setting of the equipment for print. Parameters of the profiles are preset by the manufacturer and can be changed in the equipment's menu. Besides basic profiles **automat** (**auto** button), **manual** (**man** button) and **print screen** (**print screen** button) it is possible to set many user profiles (when pressing the **profile** button, the available profiles cyclically shift).

The set profile parameters can be changed by pressing of the respective button at any time before and/or during recording.

To start recording of the signal press the **print** button. Termination of recording is either automatic after the time set in the profile elapses, or manual by pressing the **stop** button. Depending on the set profile, the device may record data or analyse the signal for some more time. If the device is performing a background job, a small blinking circle appears in the upper right corner of the display, or a circle with the text "wait please". The analysis and storage of the signal may be very time-consuming operations.

3.3 POSITION OF ELECTRODES

Quality of the ECG record is particularly dependent on the contact between the electrode and the patient's skin. To keep the contact as good as possible please observe the following principles:

- the skin should be warm and the patient relaxed
- before fastening the electrode cleanse the skin with alcohol
- apply sufficient layer of gel on the electrode

It is recommended to fasten the electrodes in the following order:

- first fasten the **N** electrode to the right leg
- then fasten the other limb electrodes **R, L, F**
- finally fasten the chest electrodes in the following order: **V4 – V2 – V1 – V3 – V6 – V5**

The following two parts of this document contain the detailed description of the electrodes position.

3.3.1 Limb Electrodes



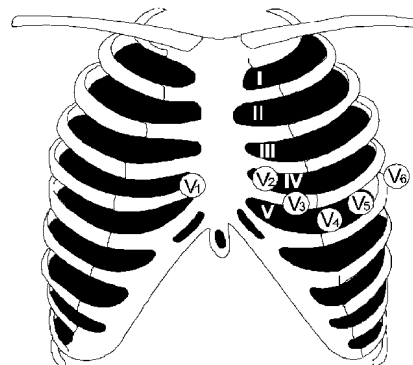

R – red	- right arm
L – yellow	- left arm
F – green	- left leg
N – black	- right leg

3.3.2 Chest Electrodes

V1 – red	- the fourth intercostals space to the right from the sternum
V2 – yellow	- the fourth intercostals space to the left from the sternum
V3 – green	- in the middle between V2 and V4
V4 – brown	- the fifth intercostals space in the MDCL line
V5 – black	- at the level of V4 in the front auxiliary line, evenly between V4 and V6
V6 – violet	- at the level of V4 in the central auxiliary line



3.4 EXAMINATION PROCESS

- Switch on the equipment by the **on/off** button: 
- To enter the name of the patient to be printed in the record press the button:  (optional)
- Select the print profile – e.g. **auto**: 
- Fasten the electrodes to the patient's body. Make sure that all leads are properly connected and that ECG does not report any loose leads; possibly check if the signal on the display is clear.
- If everything is OK press the **print** button to start printing: 

(If in the automat mode the check of leads is ON in the profile, the device waits for fastening of electrodes and starts recording only when contact of all electrodes is OK)

3.4.1 Examination in the Automat Profile

Process of examination:

SWITCH ON the unit using the **on/off** button – **FASTEN THE ELECTRODES** – **SELECT PROFILE** using the **auto** button (Unit Setup) – **START RECORDING** using the **print** button – **AUTOMATIC TERMINATION**.

Before start of recording check and possibly modify the following parameters (**cannot** be changed during recording):

- paper speed - the **mm/s** button
- sensitivity - the **mm/mV** button
- number of leads - the **number of leads** button
- leads required to be printed - the **select leads** button
- set the required filters using the **filter** and **drift** buttons.

Press the **print** button. The device starts recording of the ECG signal and printing of the curves on the thermo-sensitive paper; at the same time, the signal is stored in the records database.

Examination will be automatically terminated after the time set in the profile elapses; it also can be interrupted at any time by the **stop** button.

If printing of diagnosis and table of analysis is not set but you still want to print it, press the **analyse** button (only the types with DIAGNOSTICS).

If you want to print the record again set the print options using the keyboard and then press the **copy** button.

To perform automatic recording of another patient press the **print** button.

3.4.2 Examination in the Manual Profile

Process of examination:

SWITCH ON the unit – **FASTEN THE ELECTRODES** – **SELECT PROFILE** using the **man** button (Unit Setup) – **START RECORDING** using the **print** button – **TERMINATE** or **INTERRUPT** recording using the **stop** button.

Before start of recording check and possibly modify the following parameters (it is also possible to change them during recording):

- paper speed - the **mm/s** button
- sensitivity - the **mm/mV** button
- number of leads - the **number of leads** button
- leads required to be printed - the **select leads** button
- set the required filters using the **filter** and **drift** buttons.

Press the **print** button. The device starts printing of the curves on the thermo-sensitive paper.

To terminate recording press the **stop** button.

To print record of another patient press the **print** button.

Note:

In the **manual** mode the data of the ECG signal are not stored in the records database.

3.4.3 Examination in the Print Screen Profile

Process of examination:

SWITCH ON the unit – **FASTEN THE ELECTRODES** – **START RECORDING** using the **print screen** button – **AUTOMATIC TERMINATION** or **INTERRUPTION** by the **stop** button.

The process is very similar to that in the **automat** mode – see Chapter **Examination in the Automat Profile**.

3.4.4 Examination in the User Profiles

Process of examination:

SWITCH ON the unit – **FASTEN THE ELECTRODES** – **SELECT PROFILE** using the **man** button (Unit Setup) – **START RECORDING** using the **print** button – **AUTOMATIC TERMINATION** or **INTERRUPTION** by the **stop** button.

Further process of examination is very similar to that in the **automat** resp. **manual** mode – see Chapter **Examination in the Automat Profile** or **Examination in the Manual Profile**.

3.4.5 Examination in the Long Profile

Process of examination:

SWITCH ON the unit – **FASTEN THE ELECTRODES** – **SELECT PROFILE OF THE long TYPE** using the **man** button (Unit Setup) – **START RECORDING** using the **print** button – **AUTOMATIC TERMINATION** or **INTERRUPTION** by the **stop** button.

Further process of examination is very similar to that in the **automat** mode – see Chapter **Examination in the Automat Profile**.

3.5 RELIABILITY OF MEASURING AND DIAGNOSTICS

Parameters that are analysed on the basis of an averaged heart cycle are considered correct if the relevant record is not distorted too much by the mains noise, by artefacts of myopotentials, or by other noises. Another factor for reliability is that the unit correctly recognises the key points of the P-QRS-T complex. The accuracy of parameters may be also affected by inclusion of aberrant cycles to the averaged cycle in case that the unit incorrectly classifies them as typical for the given record. The unit attempts to determine the parameters of every record automatically; therefore it is necessary to ensure that at least three cycles typical for the record analysis are correctly averaged and that the number of aberrant cycles does not exceed the number of non-aberrant ones.

3.6 USE OF FILTERS

Fully automatic adaptive filter (adaptive auto) – a filter which performs permanent analysis of the recorded signal and on the basis of the acquired data filters the signal so as to achieve the optimum result. This filter comprises all other filters automatically therefore; it CANNOT be combined with other filters.

ADAPTIVE-AUTO FUNCTIONALITY DESCRIPTION - the basic idea of muscle tremor filtering is based on low-pass filter with optional cut-off frequency can lead to unsatisfactory result in ECG parts with low signal frequencies and also to distortion of amplitudes in parts with high frequency content e.g. QRS complex. The adaptive filter as a new technique process ECG signal the same way as simple low pass filter with respect to signal frequency content. This approach gives more effective results in noise filtering and in preservation of signal amplitudes, especially in QRS complexes.

The raw signal of ECG (fig 1) is analyzed by rough curvature analyzing process resistant to powerline and muscular noise, which control function, is derived from (fig.2). The control function enters to decision and executive block consisting of four short FIR filters with different cut-off frequencies where all of the filters are executed but outputs of them are weighted by fuzzy rules and reconstructed to clean ECG signal according to control function, i.e. parts of P wave or T wave are reconstructed with respect of their content of frequencies around 0 – 15 Hz, and in parts of QRS complex frequencies of 0 – 100 Hz are kept for good spike and slope representation. (fig 3)

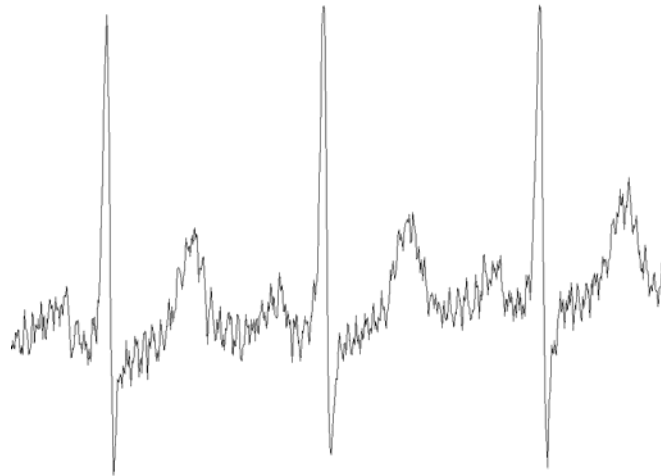

Figure 1
The original raw signal of ECG

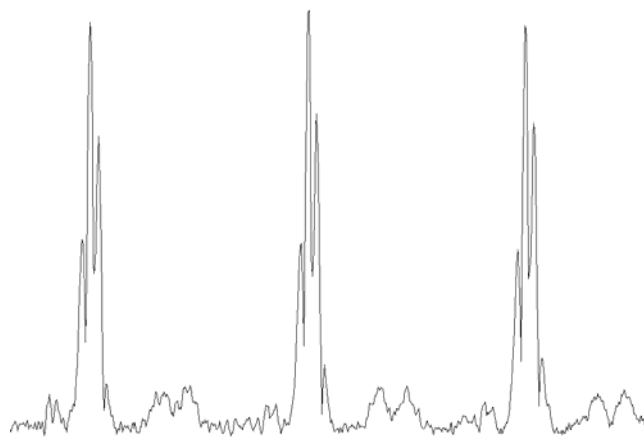

Figure 2
The control function as mentioned above in text

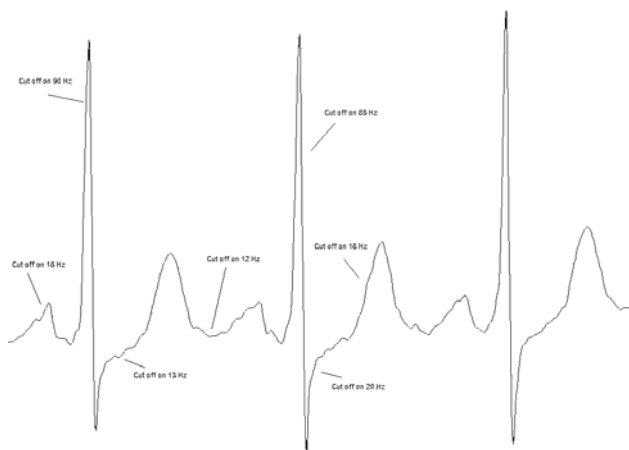

Figure 3
Output signal with Cut off frequencies

The adaptive filter is as complex filtering method enhanced by cubic spline baseline wander filtering. The baseline points are extracted from original signal by ECG segment analysis and interpolated by piecewise cubic splines method to remove baseline wandering with respect to low frequency content of ECG signals e.g. ST segments and the other “slow” parts. The brief explanation is on figure 4.

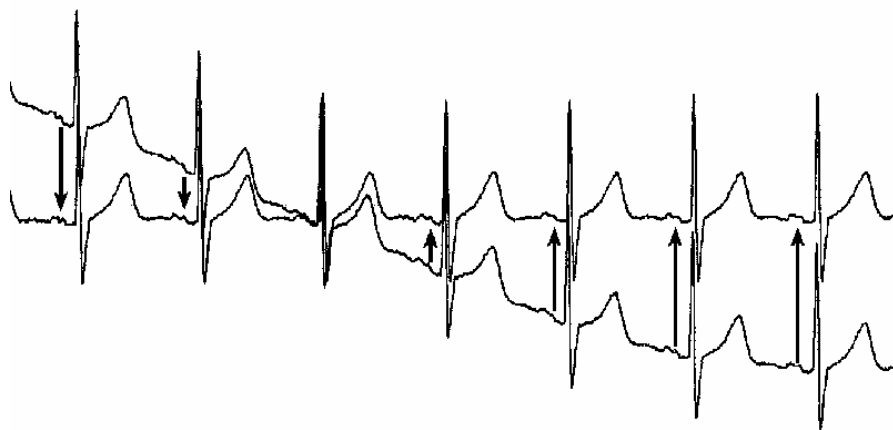

Figure 4
Original ECG signal with baseline wandering and his spline baseline removal

Adaptive filter of mains noise (50 Hz-60 Hz) – a filter designed for reduction of the noise that penetrates the record from the mains, with the ability of adaptation to the changes in the frequency of the noise. Harmonic (sinus) waveform with a period of approximately 1 mm at the record speed of 50 mm/sec is typical for this type of noise. The filter does not affect any of the diagnostically important parameters of the record. "Adaptive" means that the filter can automatically adapt to both mains frequencies 50Hz and 60Hz. For faster stabilization of the filter it is recommended to set the correct value according to the current mains in **menu-unit setup-user setup-more...-mains frequency**.

Muscular filter 35 Hz – a filter with cut-off frequency 35 Hz designed for removing of muscular artefacts. This noise is characterised by non-harmonic waveform with short random period. This filter removes the mains noise as well. It is therefore useful to choose its combination with the mains filter – setting “35.50Hz”.

Muscular filter 25 Hz – a filter with cut-off frequency 25 Hz designed for removing of muscular artefacts and possible electromagnetic disturbance from other electric appliances. This noise is characterised by non-harmonic waveform with short random period. This filter removes the mains noise as well. It is therefore useful to combine it with the mains filter – setting “25.50Hz”. In certain cases, this filter can influence some values of amplitudes of the QRS complex.

Anti Drift System – base line: – filters for removing of the base-line drift. Use these filters in cases when the base-line drift in the recorded examination is significant. Follow this scheme: As the starting filter always use the filter with the longest time constant – ADS 3.2 sec. If the base-line drift is significant and the ECG record escapes from the record (or from the display), switch the ADS filter successively to the filters with faster reaction, i.e. with shorter time constant. That is, from the original value ADS 3.2 sec towards the value of 0.1 sec. However, the value ‘heart rate x time of reaction of the filter’ should always be much more than 10, so that the record is not significantly influenced. When using these filters with fast reaction (small number in the filter's name – 0.1 sec) it is necessary to keep in mind that filtration may in some cases result in some distortion of the P-QRS-T intervals. This is especially true for the diagnostically important S-T interval.

Good results are achieved with the setting of ADS 1.5sec – we recommend using of this particular filter. In case of complicated conditions during the recording of the ECG signal (strong electromagnetic disturbance, scanning of ECG without using of high-conductivity gel, and the like) we recommend using the ADS filter 0.6sec.

Splines filter

A new generation filter, which is able to suppress the base-line fluctuation almost perfectly, while all important parameters of the ECG signal remain preserved. It is based on the parameters of the record and on the precisely specified points in the record, which enables it to eliminate considerable interference of this type.

All the stated filters can be mutually combined so that the filtration of the record is optimum.

4 SETUP MODE

4.1 MAIN MENU

To enter this menu, press the button **menu** in the lead monitoring mode. The menu can be also entered using the touch screen: After touching the display at any point there appear the top and bottom toolbars. After pressing the **menu** button (in the lower right corner) there opens the main menu. Here you can select from the following options:

- Record Database
- Unit Setup
- Profile Setup
- Select Physician
- Displayed Leads

4.1.1 Record Database

This menu enables to open, view and print the last taken records. The records are stored in the memory automatically. If the memory is full, the next taken record overwrites the oldest stored record. The records which are marked as **archive** (**mark** button, a + sign is displayed in front of the record) are not overwritten and remain in the memory permanently (if you want to delete them, you have to do it manually).

With the selected record you can perform the following actions:

- reprint the record with the setting which it was recorded with, or with any other setting
- change the print profile
- view the record on the display, including analysis
- mark/unmark the record as archive
- delete the selected record or all records at a blow
- display the record optionally sorted according to the attribute archive, date, name or ID
- export the selected record, current record or all records to the PC. To receive data from the unit the PC must be equipped with the registered BTL-08 Win or BTL-08 Ergo software. The unit must be connected to the PC or modem by a cable. Data are transferred via the selected transfer channel, see Chapter **Export Setup**.

Note:

The records are stored in the memory in compressed format, so that there can be stored as many records as possible. That is why at first entering the archive the device has to convert these records into readable format. This operation may take several seconds, depending on the number of the stored records.

4.1.2 Unit Setup

This submenu includes the following options:

- select profile which the device starts with after switch-on (**starting profile**)
- set maximum heart rate alarm (**max. heart rate**)
- switch on / off acoustic signalling of the QRS complex (**QRS acoustic signal**)
- set the lead from which the device determines the heart rhythm (**rhythm lead**)
- set the ECG-signal print line width (**line width**)
- select information to be displayed in the patient card (**patient card setup**)
- set optional patient data (**optional patient data**)
- set the print parameters and the used paper type (**setting of paper and print**)
- set the parameters of export of the stored records to PC (**export setup**)
- enter another user setup menu of the device (**user setup**)

4.1.2.1 Starting Profile

Here you can select the profile that will be automatically set after switching the equipment on by the **on/off** button.

4.1.2.2 Max. Heart Rate

Here you can set the heart rate value, which the equipment will consider the highest allowed. If the measured heart rate is higher than this set value the equipment makes warning by high intermittent beeping. If this maximum heart rate value is set to zero – 0 – the function is disabled.

4.1.2.3 QRS Acoustic Signal

Here you can enable/disable the acoustic signalling of QRS complex of the ECG-curve.

4.1.2.4 Rhythm Lead

Here you can set from which lead the device will determine the heart rate. In most cases it is not necessary to change the default settings, in special cases the lead can be changed (e.g. in some types of ergometric examination).

4.1.2.5 Line Width

Here you can set width of the ECG-curve printed on the paper. The setting shall be refined according to the used paper. This setting influences only the printing of the ECG-curve itself, not the printing of other information (texts, grids, pictures). Using this setting, together with setting of the suitable paper sensitivity (see above) it is possible to achieve the optimum appearance of the print.

4.1.2.6 Patient Card Setup

The enabled items appear during entering the patient data and can be filled in. The data are stored with the patient. In the patient card you can enable the following items:

- name
- surname
- third name
- ID
- age
- sex
- weight
- blood pressure
- height
- pacemaker
- 2 user-defined items, the meaning and description of which can be set in **Optional Patient Data**.

4.1.2.7 Optional Patient Data

Here you can define names of two optional items of the patient card – e.g. *diagnosis, general state...*

4.1.2.8 Setting of Paper and Print

Here it is possible to set many important parameters of printing: if selected printer is internal or USB, if the print paper is perforated or for fax, if the grid shall be printed, paper sensitivity, and it is also possible to get the paper inserted after its replacement.

Setting of paper sensitivity is important for optimum printing, and besides the line width it influences the print quality the most. For details on paper settings see Chapter **Printer and Paper**.

4.1.2.9 Export Setup

Here you can select which of the available transfer channels will be used for export of data to the PC. At the same time, it is possible to configure the channel. In most cases, the default setting is sufficient. Data are transferred from the unit to the BTL-08 Win or BTL-08 Ergo program. The selected communication channel will be used in the **export** option in the Record database, see **Record Database**.

4.1.2.9.1 Transfer: Serial Cable->BTL08

When exporting data to the PC via the cable, no special setting is necessary. The connection speed is 115200baud. The BTL08Win/Ergo program must be running on the PC and the receiving form must be open.

The option **enable online export through serial cable** enables direct (online) sending of data via the serial line to the PC program BTL-08 Win. Data will be sent whenever the BTL-08 Win program on the PC is run in the Automat mode and the leads are being drawn on the on-line screen.

4.1.2.9.2 Transfer: Modem->BTL08

When exporting via the phone line, a modem or a mobile phone equipped with a hardware modem must be connected to the ECG.

Write in the **init string** box the initialization text string for putting the modem into the required mode. For details on individual commands in the initialization string see the User's Guide of the modem. The default settings work with most of the standardly sold modems.

The **dial string** box contains the phone number of the called telephone. Enter the phone number including the test string at the beginning: ATDT for tone dialling (new exchanges and mobile phones) ATDP for pulse dialling (older exchanges).

Example: for calling the number 2 333 555 84 using the tone dialling enter ATDT233355584.

Schematic connection of ECG at the data export to a PC via modem and dial-up line

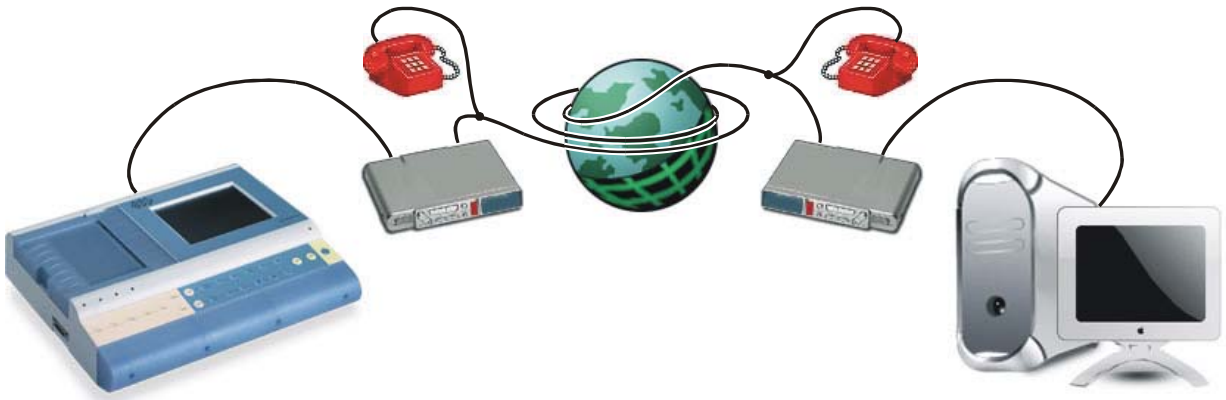

Schematic connection of ECG at the data export to a PC via mobile phone



4.1.2.9.3 Transfer: USB->BTL08

Export via USB serves for exporting all records from the Records database, all patients from the Patients database and all physicians from the Physicians database into the PC via the USB A/A cable. During the export the computer displays a removable disk called "**ecg data**", which contains three directories: "**Records**", "**Patients**" and "**Doctors**".

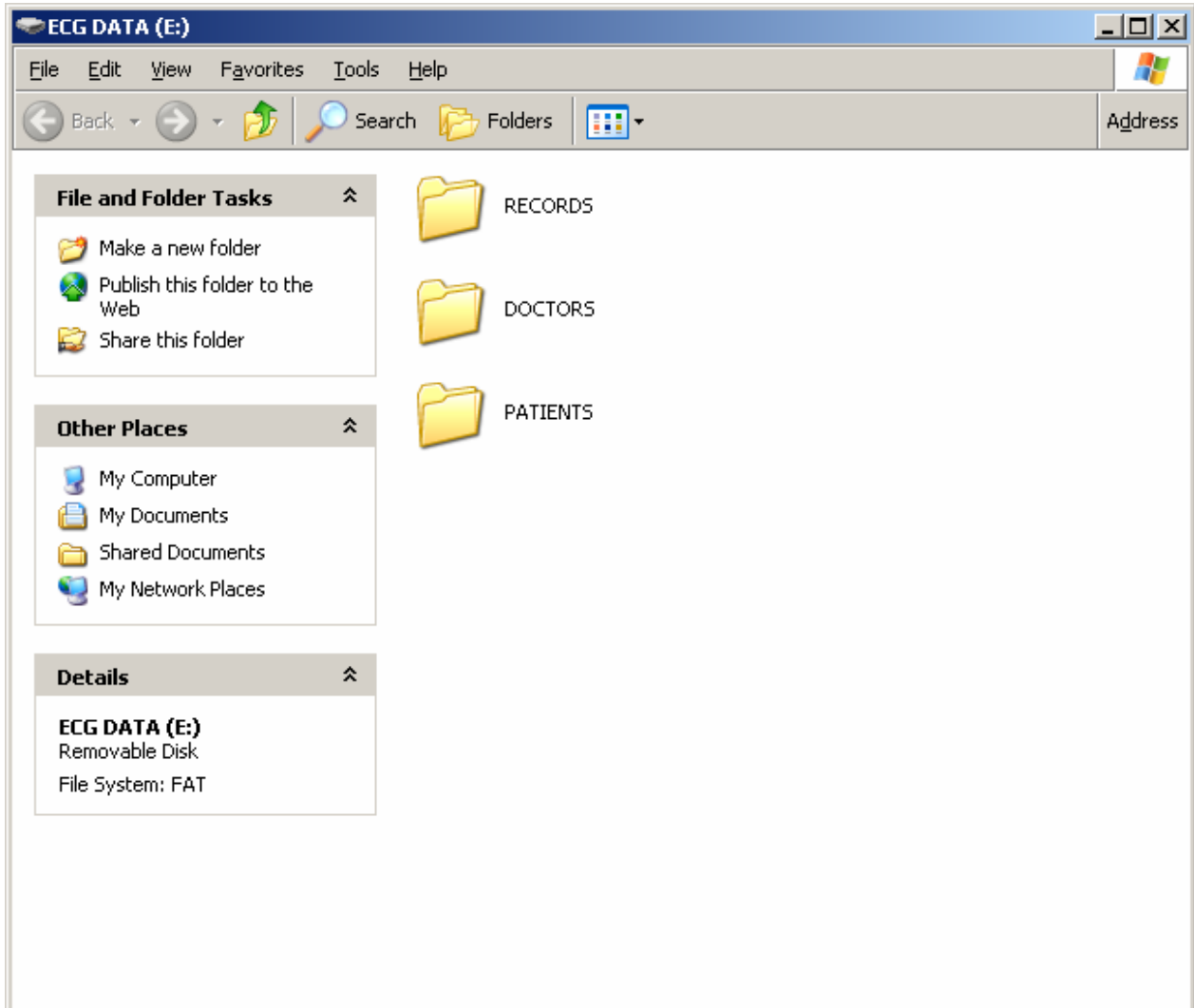

The "**Records**" directory contains XML files called **RecN.xml**, where **N** is a number from 0 to 119 representing the position in the device's memory on which the file is saved. Each file contains data of one record. In addition a file called "**Records.txt**" is created in this directory, containing the list of all exported files with the date of recording and the name of the patient whom the record belongs to.

The "**Patients**" directory contains XML files called **PatN.xml**, where **N** is a number from 0 to 119 representing the position in the device's memory on which the file is saved. Each file contains data of one patient. In addition a file called "**Patients.txt**" is created in this directory, containing the list of all exported files with the name of the patient.

The "**Doctors**" directory contains XML files called **DocN.xml**, where **N** is a number from 0 to 119 representing the position in the device's memory on which the file is saved. Each file contains data of one physician. In addition a file called "**Doctors.txt**" is created in this directory, containing the list of all exported files with the name of the physician.

You can copy the files of records, patients and physicians from these directories to your PC's hard disk and/or backup them on a CD, DVD or another backup medium. You can also import them to the database of our PC software BTL08Win/Ergo using the importing form in BTL08Win/Ergo.

Option **type of exported data** enables to set three various formats of the exported signal data:

- **standard export** – the signal data are not compressed, the xml file can be read in Internet Explorer and the samples of the signal are saved as a set of numbers for each lead
- **fast export** – the signal data are compressed, the xml file can be read in Internet Explorer and the compressed leads are saved in the hexadecimal format
- **ultra fast export** – the signal data are compressed, the xml file cannot be read in Internet Explorer and the compressed leads are saved as binary data

Setting of the option **enable online export through USB** enables direct (online) sending of data via USB to the PC program BTL-08 Win. However, this program supports the USB import only for the versions 5.30.0 and higher. Direct sending of data to BTL-08 Win depends on the speed of the PC. It is also necessary to meet the below-listed PC requirements, otherwise there is a risk of the sent data dropout – in such case the data loss message appears. This risk on the slow PCs may be eliminated by closing all other applications except BTL-08 Win.

The export itself is run in the **Record Database**. Unlike export via modem or serial cable, always all records are exported, not only the marked or selected ones.

After the export you can also perform **import of records, patients and physicians** according to the following rules:

- the xml files of the records, which you want to import, must be copied in the PC to the "**Records**" directory of the "**ecg data**" removable disk. The names of the files must be **RecN.xml**, **N** = number from 0 to 119 representing the position in the device's memory on which the file will be saved.
- the xml files of the patients, which you want to import, must be copied in the PC to the "**Patients**" directory of the "**ecg data**" removable disk. The names of the files must be **PatN.xml**, **N** = number from 0 to 119 representing the position in the device's memory on which the file will be saved.
- the xml files of the physicians, which you want to import, must be copied in the PC to the "**Doctors**" directory of the "**ecg data**" removable disk. The names of the files must be **DocN.xml**, **N** = number from 0 to 119 representing the position in the device's memory on which the file will be saved.

Before leaving the export screen it is necessary to remove safely the USB device from the PC operating system in the same way as any other USB device. After leaving the export screen in the **Record Database**, all files of the records, patients and physicians on the removable disk are saved in the device's memory and are available in the **Record Database** and in the **Select Patient** and **Select Physician** options.

Limitations:

- USB export/import is supported only by units of version 110 and higher (see manufacture label on the bottom cover)
- USB export/import is supported for firmware version 1.42 and higher, for firmware version see **Unit Information**
- the recommended length of the USB cable is 1m, for longer distances use the recommended USB HUB

PC requirements:

- PC must be equipped with the USB port USB1.1 or USB2.0
- the minimum configuration necessary for direct (online) sending of data to the PC program BTL-08 Win is: Intel Pentium III 1.0GHz, RAM 128MB
- the supported operating system is Windows XP and Windows 2000

4.1.2.10 User Setup

4.1.2.10.1 Date / Time

Setting of date and time in the device. This date and time are stored and printed together with the records. The device remembers the set date and time even if it is unplugged from the mains and the accumulators are low.

4.1.2.10.2 Display Contrast

Here it is possible to set the required display contrast. The function is the same as after pressing the **contrast** button in the on-line screen. For setting of contrast use the arrow buttons on the touch screen or on the keyboard.

Note:

At the colour display, the change of contrast may lead to change of the colour representation of the current colour scheme.

4.1.2.10.3 Select Language

Setting of the language in which the equipment communicates. The change of language does not occur before restart of the equipment.

4.1.2.10.4 Touch Panel Calibration

If after touching of the touch screen there react other display buttons than required, it is necessary to calibrate the touch panel. The process of calibration is described on the display - follow the instructions. For calibration use the touch-pen.

If calibration does not proceed successfully you can interrupt it at any time by pressing **esc**.

For check of the result of calibration use the **touch panel function test** function.

4.1.2.10.5 Repair of Files

If the stored data are corrupt because of interference or a device fault, there may appear errors in the file system (loss of some records, loss of some of the stored patients). This function starts diagnostics of the file system and tries to repair the fault without loss of the stored data, if possible. Depending on the amount of the stored data, this function can take a very long time (hours), therefore we recommend running this function e.g. overnight. If this function is run, it is necessary to wait until it is complete or to **reset** the device - see Chapter **Functions of the Keyboard Buttons**.

4.1.2.10.6 File System Formatting

This function initializes the entire file system, i.e. it deletes all data stored in device and puts the device into the initialized state (i.e. the same state as at purchase of the device). This function should be used only in case of a serious breakdown or if the user wants to initialize the device completely.

4.1.2.10.7 Default Setting - No User Data Loss

This function puts the device into the same state as at purchase (setting of language, colours, etc.) and at the same time it keeps all stored data of profiles, patients, physicians and records.

4.1.2.10.8 Sleep Mode Interval

Here you can set the time of inactivity after which the equipment switches off.

4.1.2.10.9 Battery Status Indication

Here you can enable/disable the acoustic signalling of low battery (short fast beeping). The visual indication cannot be disabled.

4.1.2.10.10 Demo

Here you can switch on/off the demo mode of the signal recording. If the Demo mode is on, the device behaves as if it were connected to the patient, although it is not. The Demo mode is indicated by bold letterings DEMO on the on-line screen as well as on the printed record.

4.1.2.10.11 More...

This button opens additional items of the user setup.

4.1.2.10.12 Unit Information

In this item all key information about the unit configuration is listed: serial number, firmware version, until when the function of the device is limited, version of diagnostics, temperature of individual parts of the device, version of firmware of the print module and configuration of the HW key. This information will be needed in case of communication with the sales department.

4.1.2.10.13 Information about Filesystem

This item contains some important information about the filesystems in the device. It serves only for service purpose.

4.1.2.10.14 Setting of Filter 50 Hz / 60 Hz

Setting according to the mains frequency. The applied mains filter retunes automatically according to the actual mains interference frequency. This setting sets the initial frequency on which the mains interference is looked for and thus shortens the response time of the mains filter.

4.1.2.10.15 Setting of HW Key

The device can be configured remotely. For example, if you decide to buy the DIAGNOSTICS upgrade later, the manufacturer (distributor) sends you the 64-digit code (so called **HW key**) which you enter here and the device reconfigures according to the entered key. For determination of the current HW configuration see **Unit Information**.

4.1.2.10.16 Password Setting

To prevent unauthorized handling of the device, it is possible to activate the password request after the switch-on. Here it is possible to enable/disable the password request and/or change password. The password is a numeric string of any length. If you forget your password, you can always use the string **00000000**.

4.1.2.10.17 Unlock Code

If the time of operation of the device is limited (e.g. by 12 October 2004), after this date the work with the device will be disabled. In this item it is possible to enter the code for "unlocking" of the device. To check if the device function is limited see **Unit Information**. For the unlock code contact the manufacturer or your distributor.

4.1.2.10.18 Colour Schemes and Colours of Leads

These options are active only in the colour device (model LC). They enable to change the colour representation of the display. Several colour schemes are factory-preset; in addition it is possible to create, edit and delete the user colour schemes. You can also assign a colour to each displayed lead and element.

4.1.2.10.19 Fast Data Processing

Here you can set the speed of the data processing algorithm for data recording in modes derived from the **automat** mode. Fast processing significantly reduces the time elapsing from pressing the **start** button till completion of data processing and the following printing. In some isolated cases, slow processing may lead to better results. We recommend keeping this option on, which considerably speeds up the routine operation of the device.

4.1.2.10.20 Automat Profile Print Speed

The speed of resulting printing in the profiles derived from the automat profile is always constant and independent of setting of the recording speed. This option enables to change the basic speed. **Middle** speed is 25mm/s and provides high-quality print on most of the paper types. When using better paper it is possible to set **higher** speed (50mm/s) and thus speeds up the routine operation of the device. In isolated cases (e.g. if worse paper is used) it is possible to set **lower** speed (10mm/s).

This setting applies only for the **automat** modes and does not influence the print speed in the **manual** mode.

4.1.3 Profile Setup

Here you can set options of all print profiles, including the default profiles **automat**, **manual** and **print screen**. It is possible to add any number of additional user profiles of type manual, automat or long. It is possible to edit the existing profiles and possibly delete them (except for the default profiles that cannot be deleted)

4.1.3.1 Setting Auto, Man, Print Screen Profile Parameters

For each profile you can set the following parameters:

- profile name (**name**)
- profile type (manual, automat) (**type**)
- sensitivity (**sensitivity**)
- paper feed speed (**paper speed**)
- used filters (**select filters**)
- length of the printed and saved record (**rec. duration**) (only for the automat type profile)
- select if the record will be printed or only saved in the memory (**printed**)
- print options: (**print setup**)
 - number of leads printed on the page
 - length of printing of the records (only for the automat type and print screen type profiles)
 - leads to be printed (only for the manual type profile)
 - enable/disable the check of loose leads before the start of printing (only for the automat type profile)
 - enable/disable printing of V-leads with half sensitivity
 - data to be printed in the header of the record
 - set the time of start of printing (only for the automat and print screen type profiles) - the start time of the record may be up to 10 seconds before pressing the "print" button, i.e. -10s. If you want to record the signal starting with the moment of pressing the "print" button, set the start time of recording to 0.
 - preview (displaying of the resulting print report on the screen)

- set averaging and analysis of signal (only for the automat type profile and if the device is equipped with the DIAGNOSTICS module)
 - print leads averaging yes / no
 - print 10 seconds of rhythm
 - print analysis
 - print verbal interpretation
 - setting of type of interpretation: verbal / code
 - print everything on one page – averages, analysis and interpretation
 - averages in the upper / lower half of the page (in case of printing everything on one page)

4.1.3.2 Setting Parameters of Long Type Profiles

The long type profile (long record) enables to record and save in the equipment's memory a signal from any one or two leads of a length of up to 10 minutes. The setting is similar as with other profile types. Averaging and analysis are not possible. It is only possible to select printing of the heart rate histogram.

For each profile you can set the following parameters:

- profile name (**name**)
- profile type (long) (**type**)
- sensitivity (**sensitivity**)
- paper feed speed (**paper speed**)
- used filters (**select filters**)
- length of the printed and saved record (**rec. duration**)
- data to be printed in the header of the record (**header print setup**)
- print of the HR histogram yes / no (**histogram**)
- number of recorded and printed leads (**number of leads**)
- recorded and printed leads (**lead 1** and **lead 2**)

4.1.4 Select Patient

The equipment provides the database of patients, in which it is possible to enter, edit and delete the patients. The new patient can be also entered in the on-line mode by pressing the **patient** button. The data to be entered in the patient card can be set in the unit setup, see **Patient Card Setup**. The number of patients is limited only by the capacity of the equipment's memory

The information about the patient is printed in the header of the record according to the profile setup.

The saved patients remain in the memory even after switching the equipment off. The set current patient always sets to "blank" after switch-on.

4.1.5 Displayed Leads

Here it is possible to configure displaying of the leads on the on-line screen. it is possible to change the arrangement of displaying as well as which signals shall be displayed in the individual windows – the **select leads** button. The device remembers the setting even after being switched off. To overwrite the setting press the **mode** button.

4.1.6 Select Physician

The equipment provides the database of physicians, in which it is possible to enter, edit and delete the physicians. The number of physicians is limited only by the capacity of the equipment's memory.

The information about the physician is printed in the footer of the record according to the profile setup.

The saved physicians remain in the memory even after switching the equipment off. The set current physician always sets to "blank" after switch-on.

5 ACCESSORIES AND UPGRADE

5.1 ACCESSORIES

The equipment is not designed for use in connection with other accessories and other medical devices except those stated in this Manual.

The lists in the following chapters include all accessories that can be supplied.
For details on particular accessories see the enclosed leaflet.

BTL accessories:

- mains cable
- limb electrodes (EKK)
- chest electrodes (EPP)
- self-adhesive electrodes
- thermo-sensitive paper - for fax (with grid / without grid)
- thermo-sensitive paper - perforated
- touch-pen
- spare fuse
- BTL patient cable, type C008.108
- BTL patient cable for the self-adhesive electrodes, type C008.109
- User's Manual
- suction cup electrodes set
- software BTL-08 Win
- software BTL-08 Win Ergo
- software BTL-08 ECG Modem – ecgmodem.exe

5.2 UPGRADE

The basic version of a BTL-08Lx ECG Series device is an n-channel electrocardiograph without diagnostic interpretation of the measured data. If you decide to upgrade the capabilities of your device by automatic diagnostics you can add the Diagnostics module which enables to get and print the following items:

- **table of analysis results** time intervals, amplitudes of segments, electric axes and heart rate
- **verbal interpretation** draft interpretation of the measured results
- **leads averaging** with indication of complexes in the record
- **10 seconds of rhythm** course of rhythm and analysis
- **pacemaker** measuring and marking of pulses emitted by the pacemaker

To check if the DIAGNOSTICS module is implemented, check **menu-unit setup-more...-unit information**.

6 EQUIPMENT MAINTENANCE AND SAFETY

The service inspection including measuring of all parameters of the device and possible recalibration must be performed in intervals shorter than 30 months. The inspection and recalibration is performed by the authorized BTL service department on the basis of the user's order. If the inspection is not done in the stated term the manufacturer does not guarantee the technical parameters and safe operation of the product.

Keep the device clean, do not store or use it for a long time in enormously dusty environment and do not sink it in any liquid. Before each use check if the equipment and its accessories (especially cables) are not mechanically or otherwise damaged. Do not use the equipment if it is damaged!

Replacement of fuse

The fuse is located in the round black box (21) on the rear panel. Before replacement make sure that the mains switch (20) is in the "0" position and unplug the mains cable from the unit. Turn the segment of the fuse box to the left by a fitting screwdriver or coin and put the fuse out. Insert new fuse and turn the box to the right. **It is forbidden to insert a fuse with another indication than stated on the label at the fuse box.**

This action may only be done by a person acquainted with this procedure.

Transport and Storage

We recommend keeping the packing of the equipment. For transport it is suitable to pack the equipment in this packing which ensures its maximum protection. Unplug the mains cable and the accessories cables. Avoid big shocks. The equipment shall be stored/transported only on conditions defined in Chapter **Technical Parameters**.

The BTL-08Lx ECG Series devices are designed for use in connection with the defibrillator. The used defibrillator must comply with the Standard IEC 601-2-4 and its discharge must correspond to that which is described in the Standard IEC 601-2-25. The equipment is resistant to defibrillation only if the original BTL patient cable is used.

The examination couch for ECG recording should be placed as far as possible from interfering fields of mains (mind the mains cables in walls) and other possible sources of interference (electrical appliances, radios) so that the quality of the records is not affected by the noise. The conductive parts of the electrodes must not touch other conductive parts of the bed and the surroundings, nor the ground.

6.1 CLEANING OF THE EQUIPMENT'S SURFACE AND OF ITS PARTS

For cleaning of the equipment and its parts use only a soft cloth slightly moistened by water or by 2 % solution of detergent. Do not use agents containing alcohol, ammonia, benzene, thinners, etc.

For cleaning of the equipment do not use abrasive materials so as to prevent damage of the equipment's surface.

No part of the equipment needs to be aseptic or sterilized.

6.1.1 Cleaning of the Touch Screen

The surface of the touch screen can be cleaned using agents designed for cleaning of monitor screens or for cleaning of glass surfaces. The agents may be applied only by means of a spray. Sprinkle the centre of the touch screen SLIGHTLY with the cleaning agent and then wipe and polish the surface using a dry cloth. Press the cloth VERY LIGHTLY, otherwise the touch screen could crack.

ATTENTION

The cleaning agent must not get under the edges of the touch screen, otherwise it could penetrate into the equipment.

The cleaning agent should not get into contact with any other part of the equipment than the touch screen.

6.1.2 Cleaning of the Paper Sensors

Once every 6 months wipe the dirt and dust from the sensors of paper by a fine brush or a dry cotton wool swab. The sensors are located under the printer cover at the upper edge of the device (two black boxes) and they are accessible after removal of the printer cover from the device.

6.1.3 Cleaning of the Printer Head

We recommend cleaning the printer head each 12 months or if the print quality gets worse. Remove the printer cover from the device and wipe the surface indicated on the picture by cotton wool wetted with industrial spirit several times. The cleaned printer head surface should be smooth and dark glossy. Fouling of the head depends on the quality of the used paper. In case of any problems contact the authorized service.

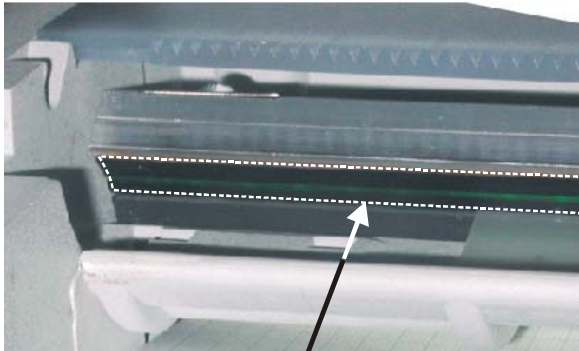

wipe the indicated area with industrial spirit

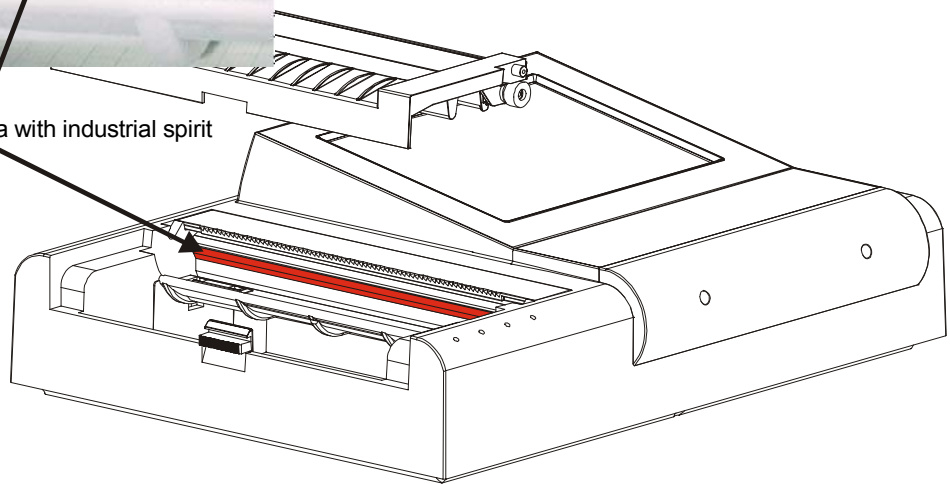

6.1.4 Cleaning of the Bearings of the Rubber roller

We recommend cleaning the bearings of the rubber roller when they start to whistle because of settled down paper dust. From the left side first take out the printer cover, screw off the screw, take out the cog wheel and the white bearing. From the other side take out first the retaining washer and white bearing (see the picture), Both of bearings clean. In case of any problems contact the authorized service.

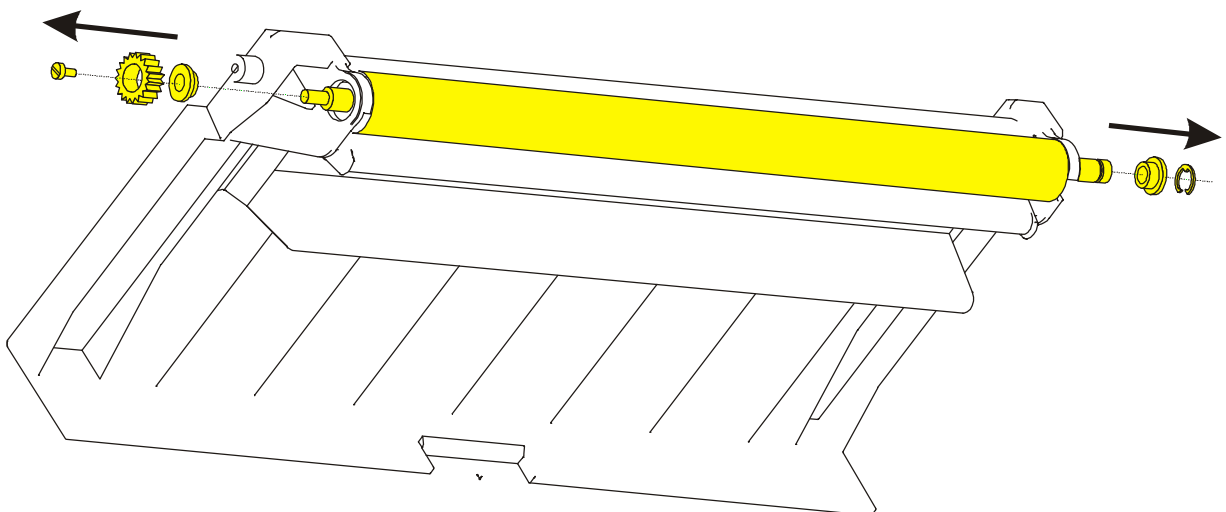

6.1.5 Cleaning of accessories which come into contact with the patient (e.g. electrodes)

We recommend cleaning these parts after treating of each patient. For cleaning use agents which were approved by the competent health officer (e.g. Sekusept, Bacilol, Incidur spray for the accessory cables, and the like).

6.2 SAFETY

ATTENTION!



In the connector marked as above only the original BTL patient cable shall be connected, which is the only cable to ensure the resistance to defibrillation.

The applied part is of the CF type.



The clamp marked as above is connected with the equipment's frame. If the ECG signal is considerably interfered it is possible to connect the clamp to the potential of the patient ground – e.g. the metal frame of the bed.

Safety Precautions

- Before first switch-on of the equipment read carefully the User's Manual.
- All staff to use the equipment must be instructed of the way of operation, maintenance and checking of the equipment and of the safety principles of its use.
- The electrical cabling which the equipment will be connected to must be installed and tested according to the existing valid standards (IEC 364). If you are not sure that the mains are completely OK get them inspected by an inspection engineer.
- Check if the parameters of the mains correspond to the requirements of the equipment according to Chapter **Technical Parameters** and if the voltage switch located on the rear panel of the equipment is switched to the correct voltage according to the parameters of the mains.
- The equipment is designed for work in the environment defined in Chapter **Technical Parameters**. It must not be used in the environment which implies e.g. the danger of explosion or penetration of water into the equipment. The equipment must not be used in connection with inflammable anaesthetics or oxidizing fluids (O₂, N₂O, etc.).
- Do not place the equipment within the reach of sunshine and strong electromagnetic fields so as to prevent undesirable mutual influence. In case that this undesirable influence occurs, place the equipment more distant from the source of interference or contact the authorized BTL service department.
- Inspect the equipment thoroughly before each use (loose cables, broken insulation of cables, functions of display, pilot lights, controls, etc.); in case of any inconsistency stop using the equipment and contact the authorized BTL service department. If the equipment's behaviour differs from the function described in this Manual stop using the equipment and contact the authorized BTL service department.
- If the equipment shows any defect or if you have doubts about its correct function, terminate therapy immediately and disconnect the equipment from the patient. If you do not determine the source of uncertainty after thorough study of the Manual, contact the authorized BTL service department. If the equipment is used out of accord with this Manual or is used even if it shows functional differences from this Manual, the user will be responsible for the damages caused by the equipment.
- Do not dismantle the equipment in any case. Removal of protective covers implies the danger of electrical injury. Possible replacement of the lithium battery and the lead accumulator may only be done by the authorized BTL service department.
- All material and parts which come into direct contact with the patient's body (cleaners for the electrodes...) must comply with the respective standards related to irritability, allergization, toxicity, genotoxicity and carcinogeneity (ISO 10993-1, ISO 10993-3, ISO 10993-5). The user is responsible for all these materials and parts if not supplied by the BTL equipment vendor.
- The connectors for accessories as well as the other connectors must not be used for connection of anything else than they are designed for according to this Manual; otherwise there is a danger of electric shock injury and serious damage to the equipment.
- During operation of ECG make sure that the conductive parts of electrodes, including the N electrode, and all other conductive patient applied parts do not touch other conductive parts in the office, nor the ground.
- The equipment does not use or produce any toxic substances during its operation, storage or transport under the stated conditions.
- After bringing the equipment from cold environment to the warmth do not plug it in the mains until the temperatures become equal (i.e. for at least 1 hour).

- The time interval between switching the equipment off and on must be at least 3 seconds.
- This equipment does not imply any danger for the patients with pacemakers.
- The equipment is resistant to the defibrillation pulse. It resumes recording the signal after 10 seconds. For this purpose use only the original BTL cable.
- Do not touch the equipment during the defibrillation discharge.
- If after many years of operation it is necessary to discard the equipment it can be done in a way which is usual for this type of devices after removal of the lithium battery and the lead accumulator. The batteries must be disposed of in a proper way – not within the municipal waste. The equipment does not contain any toxic materials which could harm the environment in case of normal way of liquidation.

Warning: removal of batteries causes irreversible damage of unit. Make only on environmental liquidation of unit!

Procedure: - Screw off the bottom cover of unit

- Remove the batteries with suitable tool (placing of batteries - see the picture)

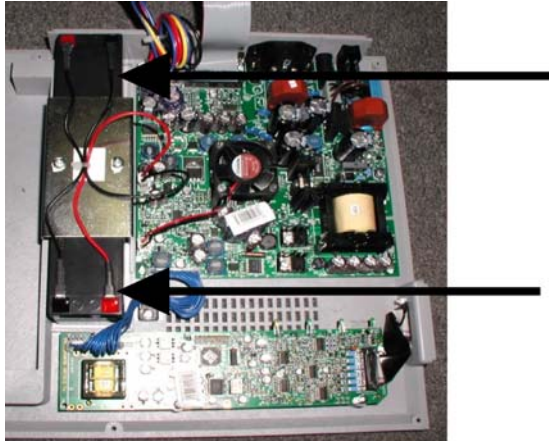

- This type of electrocardiograph is not designed for on-line monitoring of ECG signal during the work with high-frequency surgical devices. It must not be connected to the patient if a high-frequency surgical device is connected to him/her.
- This type of electrocardiograph is not designed for on-line monitoring of ECG signal in workplaces connected to life support (ICU, operating rooms, etc.)
- Owing to possible risk which could result from simultaneous connection of more various devices to the patient (mutual influence, possible endangerment of the patient by summation of the leaking currents) we do not recommend to use this electrocardiograph in connection with other devices than stated in this User's Manual.
- The equipment and the accessories must not be used in a way out of accord with this User's Manual.
- During work with this equipment use the recommended protective means.
- Keep the equipment out of reach of children.
- The equipment does not contain any components which could be repaired by the user. Do not remove any covers from the equipment. All repairs should be done by the authorized BTL service department.

6.3 USEFUL ADDRESSES

The product is manufactured in accordance with the EU Medical Devices Directive by :

BTL Industries Ltd.

161 Cleveland Way, Stevenage
Hertfordshire, SG1 6BU United Kingdom

E-mail: sales@btlnet.com

<http://www.btlnet.com>

For service, please contact service department at service@btlnet.com.

6.4 WARRANTY

The Manufacturer of this product warrants the product to be free from defects in workmanship and material for a period of twelve months after the date of shipment from the factory. This warranty excludes any disposable items and accessories, including, but not limited to cables or leads, power cords and electrodes. The manufacturer agrees to

correct such defects without charge, or at its option to replace the item with a comparable model. To register and be eligible for warranty service, you must send or fax the fully completed warranty registration form within 30 days of installation. All costs of shipment are the responsibility of the purchaser. Damage to any part such as by accident or misuse or improper installation or by use of any accessories or abrasive material not produced by the Manufacturer is not covered by this warranty. Because of varying climatic conditions, this warranty does not cover any changes in finish, including rusting, pitting, corrosion, tarnishing or peeling. Servicing performed by unauthorized persons render this warranty invalid. There is no other express warranty. The Manufacturer hereby disclaims any and all warranties, including but not limited to, those of merchantability and fitness for a particular purpose to the extent permitted by law. The duration of any implied warranty which cannot be disclaimed is limited to the time period as specified in the express warranty. The Manufacturer shall not be liable for incidental, consequential, or special damages arising out of, or in connection with product use or performance except as may be otherwise accorded by law.

This warranty may differ from the warranty terms and conditions provided by your supplier and by applicable laws in your country.

7 TECHNICAL PARAMETERS

Type:	BTL-08 LT ECG	BTL-08 LC ECG
Display:	touch screen	touch screen
dimensions (mm):	120 x 89	171 x 128
resolution:	320 x 240	640 x 480
Keyboard:	combined functions touch-panel	combined characters touch-panel
Indication of discharged battery:		acoustic, pilot light
Check of loose leads:		yes, individual leads
Paper width (mm):		210
Paper type:		for fax, perforated
Print type:		thermal, external via USB
Print speed (mm/s):		5;10;25;50
Sensitivity (mm/mV):		2.5;5;10;20
Number of leads:		12
Number of channels:		12
Number of displayed leads:		12
Measured leads:		I, II, III, aVR, aVL, aVF, V1, V2, V3, V4, V5, V6
Electrode set:		R, L, F, N, C1, C2, C3, C4, C5, C6
Number of printed leads:		
auto mode:		3, 4, 6, 12, 6x2+1, 3x4+2
manual mode:		3, 4, 6, 12
long mode:		2
Length of record:		
auto mode (seconds):		10;20;30;40;50;60;70;80
long mode (minutes):		1;2;3;4;5;6;7;8;9;10
Record in auto mode:		synchro
Saved 10-second-long records:		120
Filters:		
automatic		adaptive auto
mains filter (Hz):		50 / 60
muscular filters (Hz):		25;35
base-line filters (s)		3.2; 1.5; 0.6; 0.3; 0.1; splines
Detection of pacemaker:		
Diagnostics:	yes optional	yes optional
User profiles:		
of automat type:		unlimited
of manual type:		unlimited
of long type:		unlimited
Weight (max.):	5.7 kg	5.9 kg
Dimensions (l x w x h) [mm]:		407x312x125
Operating conditions:		
temperature:		+ 10 °C to + 40 °C
relative humidity:		30 % to 75 %
atmospheric pressure:		700 hPa to 1060 hPa
position:		horizontal – on legs
operation type:		continuous
Transport and storage conditions:		
temperature:		- 10 °C to + 55 °C
relative humidity:		25 % to 85 %
atmospheric pressure:		650 hPa to 1100 hPa
position:		any
max. duration of storage:		1 year
other conditions:		transport only in the supplied packaging recharge the accumulators at least once per year

Type:	BTL-08 LT ECG	BTL-08 LC ECG
Power supply:	100 VA	100 VA
input:	~ 100 V to 230 V (115 / 230 V nominal), alternating	
mains voltage:	50 Hz to 60 Hz	
frequency:	II (according to IEC 536)	
protection class:	T2A / 250V, tube fuse 5 x 20 mm, acc. to IEC 127-2	
external fuse:	on the rear panel, positions 0 and I	
mains switch:	IP20	
covering grade:		
Internal chemical sources:	lithium battery CR2032	
battery:	2x 12 V / 1.2 Ah, maintenance-free	
lead accumulator:	1,5 hours of ordinary use,	
accumulator capacity:	approximately 35 meters of continuous printing	
charger:	internal, time for 100 % charging approx. 6 hours	
Input impedance:	> 20 M Ω	
CMMR:	> 100 dB	
Sampling frequency:	2 000 Hz	
Frequency range (filters off):	0.04 Hz – 150 Hz	
for +10% / -30 %	0.67 Hz – 40 Hz	
for +10% / -10 %		
Amplitude accuracy:	± 2 %	
Time accuracy:	± 2 %	
Quantization noise:	3.9 μ V	
Input noise:	< 8 μ V	
A/D converter resolution:	13 bit	
Max. range of input voltage:	AC: ± 15.9 mV; DC: ± 400 mV	
Applied part:	CF type	

Applicable Standards:

Name	IEC, EN, ISO, MDD
Medical electrical equipment Part 1: General requirements for safety	IEC 601-1
Amendments to IEC 601-1	A2, A11 a A12
Medical electrical equipment Part 1: General requirements for safety 1. Collateral standard: Safety requirements for medical electrical systems	IEC 60601-1-1
Medical electrical equipment Part 1: General requirements for safety 2. Collateral Standard: Electromagnetic compatibility. Requirements and tests	IEC 601-1-2
Industrial, scientific and medical (ISM) radio-frequency equipment - Radio disturbance characteristics - Limits and methods of measurement	EN 55011
Electromagnetic compatibility (EMC) - Part 4: Testing and measurement techniques - Section 2: Electrostatic discharge immunity test - Basic EMC Publication	IEC 61000-4-2
Electromagnetic compatibility (EMC) - Part 4: Testing and measurement techniques - Section 3: Radiated, radio frequency, electromagnetic field immunity test	IEC 61000-4-3
Electromagnetic compatibility (EMC) - Part 4: Testing and measurement techniques - Section 4: Electrical fast transients/burst immunity test - Basic EMC Publication	IEC 61000-4-4
Electromagnetic compatibility (EMC) - Part 4: Testing and measurement techniques - Section 5: Surge immunity test	IEC 61000-4-5
Medical electrical equipment Part 1: General requirements for safety 4. Collateral standard: Programmable electrical medical systems	IEC 601-1-4
Medical devices - Risk analysis	EN 1441
Biological evaluation of medical devices - Part 1: Evaluation and testing	ISO 10 993-1
The Medical Devices Directive 93/42/EEC	MDD 93/42/EEC
Medical electrical equipment - Part 2: Particular requirements for safety of electrocardiographs	IEC 601-2-25
Amendment to IEC 601-2-25	A1
Medical electrical equipment – Part 2-51: Particular requirements for safety, including essential performance, of recording and analysing single channel and multichannel electrocardiographs	IEC 60601-2-51

This product is manufactured in accordance with the EU Medical Devices Directive by:

BTL Industries Ltd.
161 Cleveland Way
Stevenage
Hertfordshire
SG1 6BU
United Kingdom
E-mail: sales@btlnet.com
<http://www.btlnet.com>

For service, please contact service department at service@btlnet.com.



© All rights reserved. No part of this manual may be reproduced, saved in a research centre or transferred by any means incl. electronic, mechanic, photographic or other records without previous approval from BTL Industries Limited

BTL Industries Limited operates a policy of continuous development. Therefore, it reserves the right to make changes and improvements to the Product described in this manual without prior notice.

The contents of this document is provided "as is". Except as required by applicable law, no warranties of any kind, either expressed or implied, are made in relation to the accuracy, reliability or contents of this document. BTL Industries Limited reserves the right to revise this document or withdraw it at any time without prior notice.