

1 Data Persistence

What “data persistence” means ?

We manipulate data (represented as object state) that need to be stored

persistently to survive a single run of the application

queriably to be able to retrieve/access them

scalably to be able to handle large data volumes

transactionally to ensure their consistency

How to achieve persistence

Serialization • simple, yet hardly queriable, not transactional, ...

- stream persisting an instance of class C is deprecated once definition of C is modified (e.g. field added/removed).

Relational Databases (MySQL, PostgreSQL, Oracle, ...)

- efficient storage for data with rigid schema
- well-established and most popular technology
- efficient search using SQL standard
- secure and Transactional (ACID)

NoSQL Databases

Key-value storages (MongoDB, Hadoop, ...)

- suitable for data without rigid schema
- Object Databases
 - designed in 90’s to capture complexity of object models (e.g. inheritance)
 - Issues: scalability, standardized queries

RDF Triple Stores (SDB, TDB, Sesame, Virtuoso, ...)

- graph stores for distributed semantic web data – RDF(S), OWL

Programmatic Access to Relational Databases (RDBMS)

- JDBC (JSR 221)
 - Java standard to ensure independence on the particular RDBMS (at least theoretically)
- EJB 2.1 (JSR 153)

- Provides Object Relational Mapping (ORM), but complicated
 - (single entity = several Java files + XMLs)
- distributed transactions, load balancing
- iBatis, Hibernate – ORM driving forces for JPA 2
- JPA 2 (JSR 317)
 - Standardized ORM solution for both standalone and Jakarta EE applications

2 From JDBC to JPA

JDBC

Java standard to ensure independence on the particular RDBMS (at least theoretically)

```

Connection connection = null;
PreparedStatement statement = null;
try {
    Class.forName("org.postgresql.Driver");
    connection = DriverManager.getConnection(jdbcURL,dbUser,dbPassword);
    statement = connection.prepareStatement("SELECT * FROM PERSON WHERE HASNAME LIKE ?");
    statement.setString(1, "%Pepa%");
    ResultSet rs = statement.executeQuery();
} catch (ClassNotFoundException e) {
    e.printStackTrace();
} catch (SQLException e) {
    e.printStackTrace();
    if ( statement != null ) {
        try {
            statement.close();
        } catch (SQLException e1) {
            e1.printStackTrace();
        }
    }
}
if ( connection != null ) {
    try {
        connection.close();
    } catch (SQLException e1) {
        e1.printStackTrace();
    }
}
}

```

JDBC – entities CRUD

Create

```

PreparedStatement statement = connection.prepareStatement("INSERT INTO PERSON (id,hasname) VALUES
(?,?)");
statement.setLong(1,10);
statement.setString(2,"Honza");
statement.executeUpdate();

```

Retrieve

```

PreparedStatement statement = connection.prepareStatement("SELECT * FROM PERSON WHERE ID=?");
statement.setLong(1,2);
ResultSet rs = statement.executeQuery();

```

Update

```
PreparedStatement statement = connection.prepareStatement("UPDATE PERSON SET HASNAME='Jirka' WHERE ID=?");
statement.setLong(1,2);
statement.executeUpdate();
```

Delete

```
PreparedStatement statement = connection.prepareStatement("DELETE FROM PERSON WHERE ID=?");
statement.setLong(1,1);
statement.executeUpdate();
```

Question 1: Why prepared statements ?

```
PreparedStatement statement = connection.prepareStatement(
    "INSERT INTO PERSON (id,hasname) VALUES (?,?)"
);
statement.setLong(1,10);
statement.setString(2,"Honza");
statement.executeUpdate();
```

How to avoid boilerplate code ?

- Boilerplate code
 - Obtaining (pooled) connection
 - SQLException handling
 - creating Java objects out of the query results:

```
ResultSet rs = ...
while(rs.next()) {
    Person p = new Person();
    p.setId(rs.getLong("ID"));
    p.setHasName(rs.getString("HASNAME"));
}
```

- Although SQL is a standard – there are still differences in implementations (MySQL autoincrement, PostgreSQL serial ...)

solution = Object Relational Mapping (ORM)

3 JPA Basics

ORM Architecture

- idea: “map whole Java classes to database records”
- a typical system architecture with ORM:

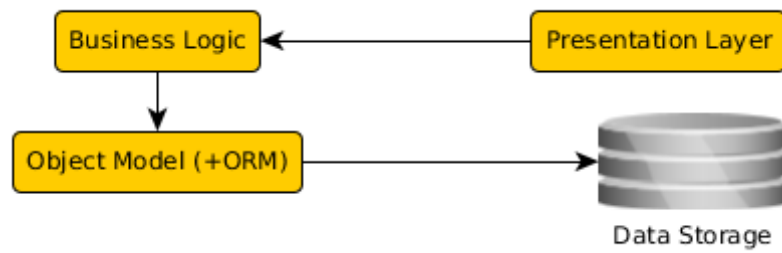

```

@Entity
public Person {
    @Id
    private Long id;
    private String hasName;
    // setters+getters
}
  
```

```

CREATE TABLE PERSON (
  ID bigint PRIMARY KEY NOT NULL,
  HASNAME varchar(255)
);
  
```

CRUD using JPA 2.0

Initialization

```

EntityManagerFactory f = Persistence.createEntityManagerFactory("pu");
EntityManager em = f.createEntityManager();
EntityTransaction t = em.getTransaction();
t.begin();
  
```

Create

```

Person person = new Person();
person.setId(10);
Person.setHasName("Honza");
em.persist(person);
  
```

Retrieve

```

Person person = em.find(Person.class, 2);
  
```

Update

```

Person person = em.find(Person.class, 2);
person.setHasName("Jirka");
  
```

Delete

```

Person person = em.find(Person.class, 1);
em.remove(person);
  
```

Finalization

```

t.commit();
  
```

JPA 2.1

- Java Persistence API 2.1 (JSR-338)
- Although part of Java EE 7 specifications, JPA 2.1 can be used both in EE and SE applications.
- Main topics covered:
 - Basic scenarios
 - Controller logic – EntityManager interface
 - ORM strategies
 - JPQL + Criteria API

JPA 2.1 – Entity Example

- Minimal example (configuration by exception):

```
@Entity
public class Person {

    @Id
    @GeneratedValue
    private Integer id;

    private String name;

    // setters + getters
}
```

JPA Basics

- Let's have a set of „suitably annotated“ POJOs, called entities, describing your domain model.
- A set of entities is logically grouped into a persistence unit.
- JPA providers :
 - generate persistence unit from existing database,
 - generate database schema from existing persistence unit.

Question: What is the benefit of the keeping Your domain model in the persistence unit entities (OO) instead of the database schema (SQL) ?

JPA – Model

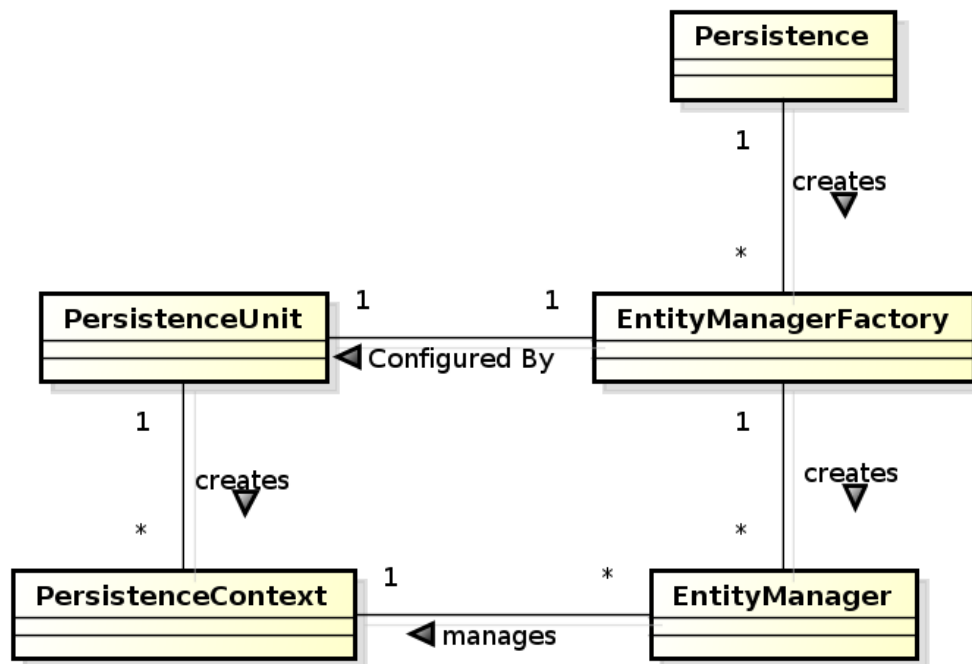

JPA 2.0 – Persistence Context

- In runtime, the application accesses the object counterpart (represented by entity instances) of the database data. These (managed) entities comprise a **persistence context (PC)**.
 - PC is synchronized with the database on demand (refresh, flush) or at transaction commit.
 - PC is accessed by an EntityManager instance and can be shared by several EntityManager instances.

JPA – Operations

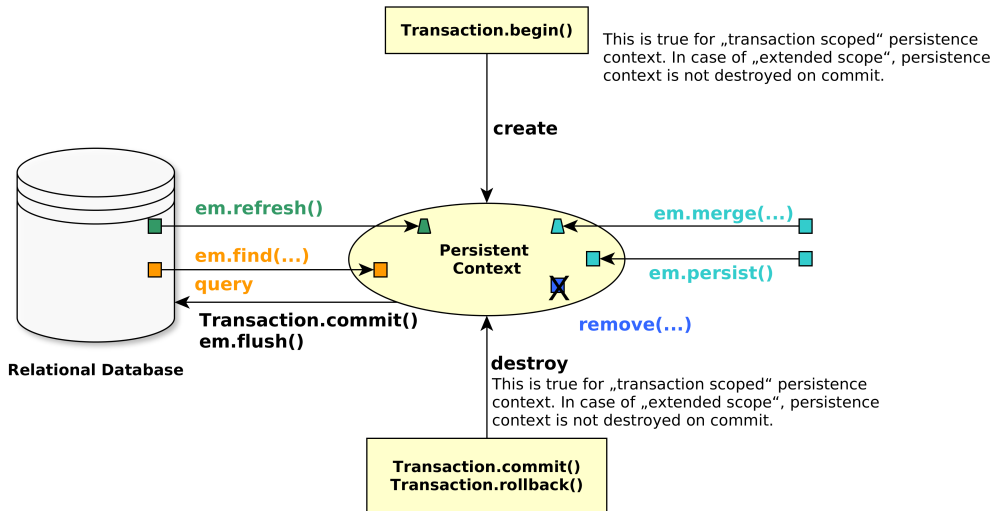

JPA – Entity States

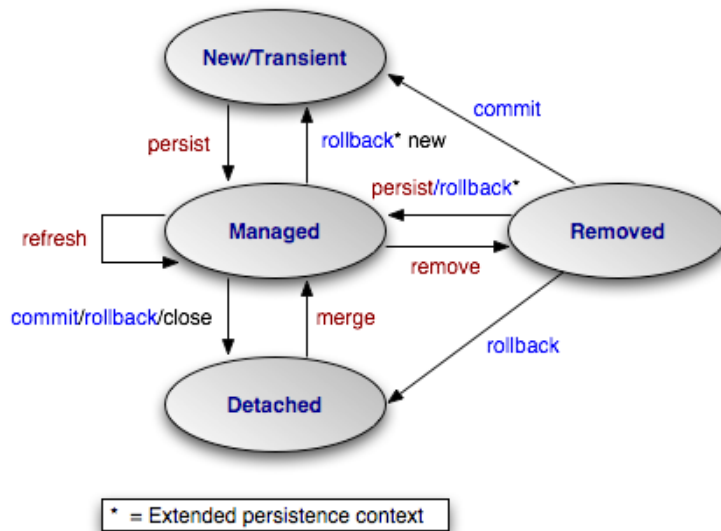

source: Wikipedia,

http://cs.wikipedia.org/wiki/Java_Persistence_API

JPA – Operation Details

persist stores a new entity into persistence context (PC). The PC must not contain an entity with the same id,

merge merges a detached entity with its managed version (inside PC),

find finds an entity in the DB and fetches it into PC,

refresh “reverts” a managed entity state from DB,
remove deletes a managed entity from PC.

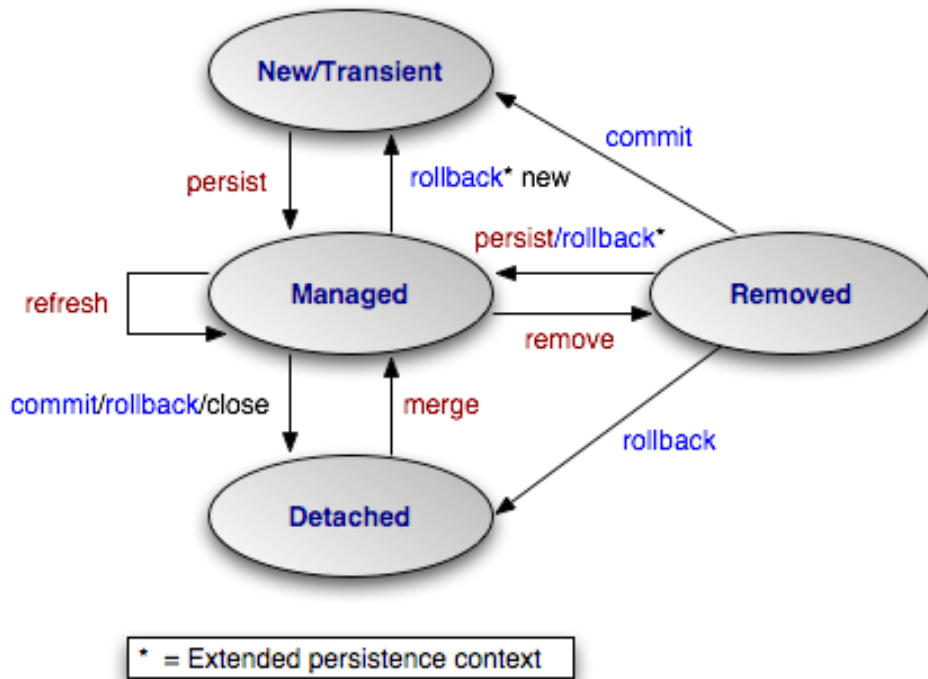

JPA – EntityManager

- **EntityManager (EM)** instance is in fact a generic DAO, while entities can be understand as DPO (managed) or DTO (detached).
- Selected operations on EM (CRUD) :
 - Create** : em.persist(Object o)
 - Read** : em.find(Object id), em.refresh(Object o)
 - Update** : em.merge(Object o)
 - Delete** : em.remove(Object o)
 - native/JPQL queries** : em.createNativeQuery, em.createQuery, etc.
 - Resource-local transactions** : em.getTransaction.[begin(),commit(),rollback()]

4 Object-Relational Mapping (ORM) Basics

Object model

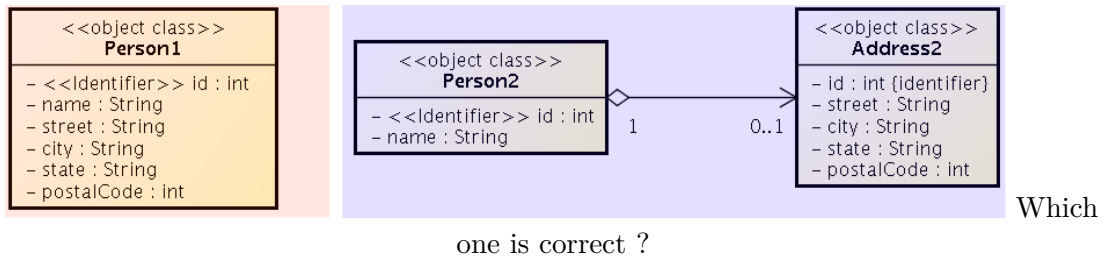

Database model

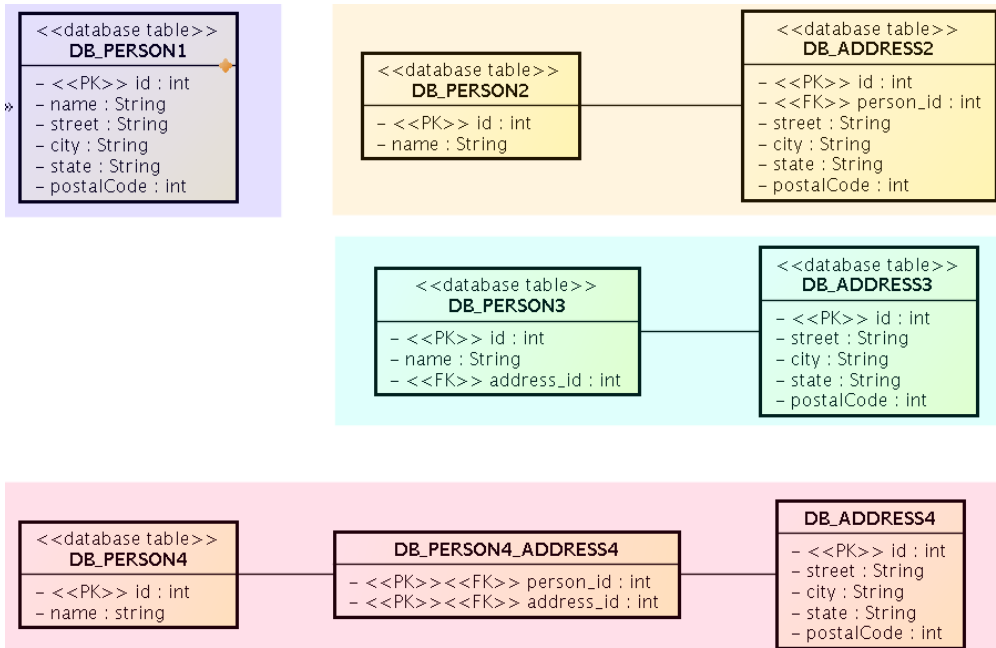

ORM Basics

Simple View

Java Classes = Entities = SQL tables
 Java Fields/accessors = Entity properties = SQL columns

- The ORM is realized by means of Java annotations/XML.
- Physical Schema annotations
 - @Table, @Column, @JoinColumn, @JoinTable, etc.
- Logical Schema annotations
 - @Entity, @OneToMany, @ManyToMany, etc.
- Each property can be fetched lazily/eagerly.

Mapping basic types

Primitive Java types:

- `String` → `varchar/text`,
- `Integer` → `int`,
- `byte[]` → `blob`,
- etc.
- `@Column` – physical schema properties of the particular column (insertable, updatable, precise data type, defaults, etc.)
- `@Lob` – large objects
- Default EAGER fetching (except `@Lobs`)

```
@Column(name="id")
private String getName();
```

Mapping enums/temporals

Enums

```
@Enumerated(value=EnumType.STRING)
private EnumPersonType type;
```

Stored either in a `text` column, or in an `int` column

Temporals

```
@Temporal(TemporalType.DATE)
private java.util.Date datum;
```

Stored in respective column type according to the `TemporalType`.

ORM – Identifiers

- Single-attribute: `@Id`
- Multiple-attribute – an identifier class must exist
 - Id. class: `@IdClass`, entity ids: `@Id`
 - Id. class: `@Embeddable`, entity id: `@EmbeddedId`

```
@Id
@GeneratedValue(strategy=GenerationType.SEQUENCE)
private int id;
```

Question: How to write `hashCode`, `equals` for entities ?

ORM – Generating Identifiers

Strategies

SEQUENCE – using the database native SEQUENCE functionality (Oracle, PostgreSQL)

IDENTITY – some DBMSs implement autonumber column (MS SQL, MySQL)

TABLE – special table keeps the last generated values

AUTO – the provider picks its own strategy

For database-related strategies, the value of id is set only on

- `Transaction.commit()`
- `em.flush()`
- `em.refresh()`

ORM – Generated Identifiers TABLE strategy

```
@TableGenerator(  
    name="AddressGen",  
    table="ID_GEN",  
    pkColumnName="GEN_NAME",  
    valueColumnName="GEN_VAL",  
    initialValue=10000,  
    allocationSize=100)  
@Id  
@GeneratedValue(generator="AddressGen")  
private int id;
```

5 ORM Relationship Mapping

ORM – Relationships

Employee – Project

Unidirectional

- accessed from **one side** only
 - `emp.getProjects()`
 - `prj.getEmployees()`

Bidirectional

- accessed from **both sides** sides
 - `empl.getProjects()`
 - `prj.getEmployees()`
- **owning side** = side used for changing the relationship
- **inverse side** = read-only side

Unidirectional many-to-one relationship

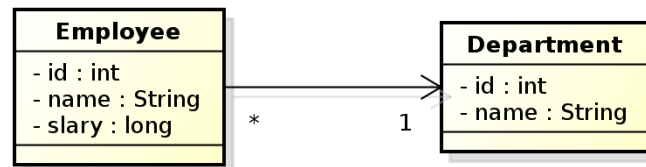

```
@Entity
public class Employee {
    // ...
    @ManyToOne
    private Department department;
    // ...
}
```

owning side = **Employee**

In DB, the N:1 relationship is implemented using a foreign key inside the Employee table. In this case, the foreign key has a default name.

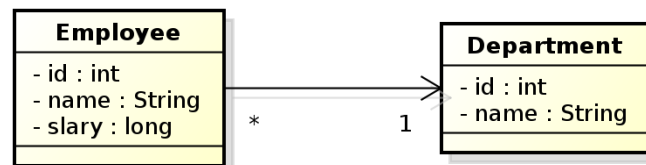

```
@Entity
public class Employee {
    @Id
    private int id;
    private String name;
    private long salary;
    @ManyToOne
    @JoinColumn(name="DEPT_ID")
    private Department department;
}
```

owning side = **Employee**.

Here, the foreign key is defined using the `@JoinColumn` annotation.
BTW what do you think about “long salary”?

Bidirectional many-to-one relationship



```
@Entity
public class Employee {
    @Id
    private int id;
    private String name;
    private long salary;
    @ManyToOne
    @JoinColumn(name="DEPT_ID")
    private Department department;
}
```

owning side = **Employee**

```
@Entity
public class Department {
    @Id
    private int id;
    private String name;

    @OneToMany(mappedBy="department")
    private Collection<Employee> employees;
}
```

inverse side = **Department**

Here, the foreign key is defined using the @JoinColumn annotation.

Unidirectional one-to-one relationship

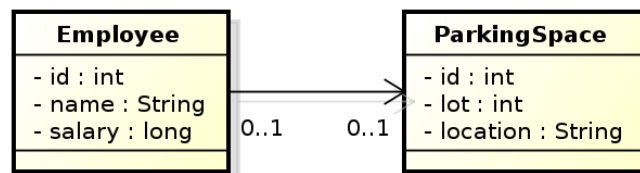

```
@Entity
public class Employee {
    @Id
    private int id;
    private String name;
    private long salary;
    @OneToOne
    @JoinColumn(name="PSPACE_ID")
    private ParkingSpace parkingSpace;
}
```

owning side = **Employee**.

Bidirectional one-to-one relationship

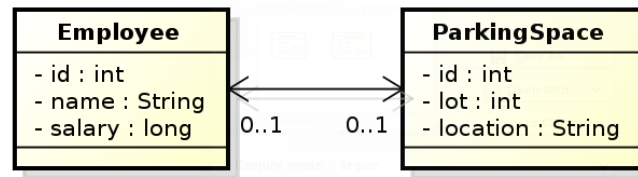

```
@Entity
public class Employee {
    @Id
    private int id;
    private String name;
    private long salary;
    @OneToOne
    @JoinColumn(name="PSPACE_ID")
    private ParkingSpace parkingSpace;
}
```

owning side = Employee

```
@Entity
public class ParkingSpace {
    @Id
    private int id;
    private int lot;
    private String location;

    @OneToOne(mappedBy="parkingSpace");
    private Employee employee;
}
```

inverse side = ParkingSpace

Bidirectional many-to-many relationship

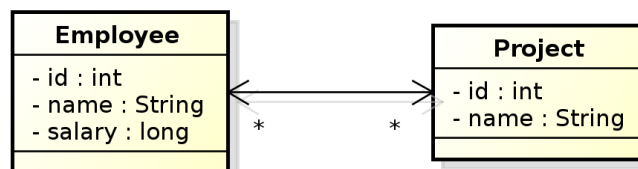

```
@Entity
public class Employee {
    @Id
    private int id;
    private String name;
    private long salary;

    @ManyToMany
    private Collection<Project> project;
}
```

owning side = **Employee**

```
@Entity
public class Project {

    @Id private int id;
    private String name;

    @ManyToMany(mappedBy="projects");
    private Collection<Employee> employees;
}
```

inverse side = **Project**

Conceptual Modeling Intermezzo

- M:N relationship is a **conceptual modeling** primitive

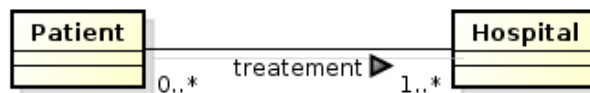

- Does it mean that
 - A patient has **one** treatment that is handled in **more** hospitals ?
 - A patient has **more** treatments, each handled in a **single** hospital ?
 - A patient has **more** treatments, each handled in **more** hospitals ?
- partialities and cardinalities are not enough in this case.

Careful modeling often leads to decomposing M:N relationships on the **conceptual level** (not on the logical level, like JPA).

Bidirectional many-to-many relationship

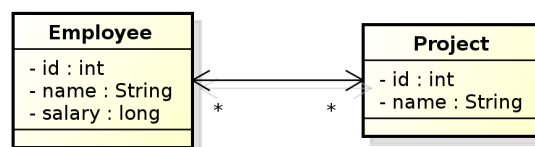

```
@Entity
public class Employee {
    @Id private int id;
    private String Name;
    private long salary;
    @ManyToMany
    @JoinTable(name="EMP_PROJ",
        joinColumns=
```

```

    @JoinColumn(name="EMP_ID"),
    inverseJoinColumns=
    @JoinColumn(name="PROJ_ID"))
    private Collection<Project> projects;
}

```

owning side = Employee

```

@Entity
public class Project {
    @Id private int id;
    private String name;

    @ManyToMany(mappedBy="projects");
    private Collection<Employee> employees;
}

```

inverse side = Project

Unidirectional many-to-many relationship

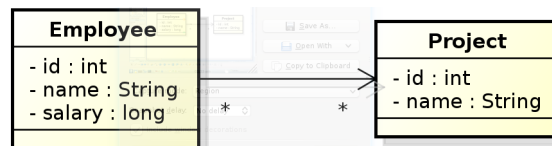

```

@Entity
public class Employee {
    @Id private int id;
    private String Name;
    private long salary;
    @ManyToMany
    @JoinTable(name="EMP_PROJ",
    joinColumns=
    @JoinColumn(name="EMP_ID"),
    inverseJoinColumns=
    @JoinColumn(name="PROJ_ID"))
    private Collection<Project> projects;
}

```

owning side = Employee

```

@Entity
public class Project {
    @Id private int id;
    private String name;
}

```

Unidirectional one-to-many relationship



```

@Entity
public class Employee {
    @Id private int id;
    private String name;
    @OneToMany
    @JoinTable(name="EMP_PHONE",
        joinColumns=
            @JoinColumn(name="EMP_ID"),
        inverseJoinColumns=
            @JoinColumn(name="PHONE_ID"))
    private Collection<Phone> phones;
}

```

owning side = Employee

```

@Entity
public class Phone {
    @Id private int id;
    private String type;
    private String num;
}

```

Unidirectional one-to-many relationship

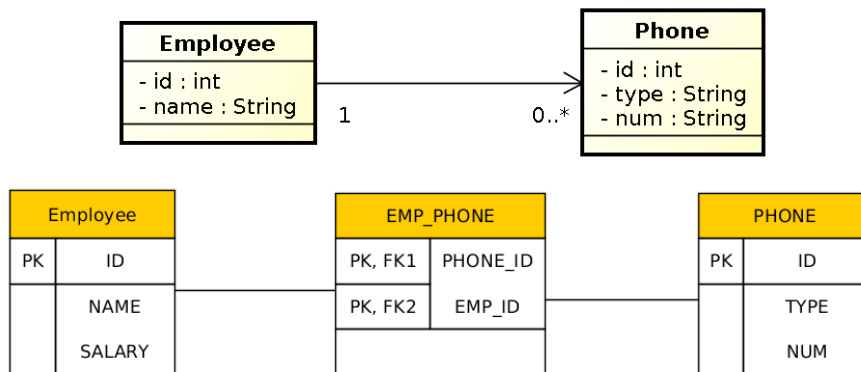

```

@Entity public class Employee {
    @Id private int id;
    private String name;
    @OneToMany @JoinTable(name="EMP_PHONE",
        joinColumns=@JoinColumn(name="EMP_ID"),
        inverseJoinColumns=@JoinColumn(name="PHONE_ID"))
    private Collection<Phone> phones;
}

```

```

@Entity
public class Phone {
    @Id private int id;
    private String type;
    private String num;
}

```

Lazy Loading

```
@Entity
public class Employee {
    @Id private int id;
    private String name;

    private ParkingSpace parkingSpace;
}
```

```
@Entity
public class Employee {
    @Id private int id;
    private String name;

    @OneToOne(fetch=FetchType.LAZY)
    private ParkingSpace parkingSpace;
}
```

parkingSpace instance fetched from the DB at the time of reading the parkingSpace field.

6 ORM Inheritance Mapping

Inheritance

How to map inheritance into DB ?

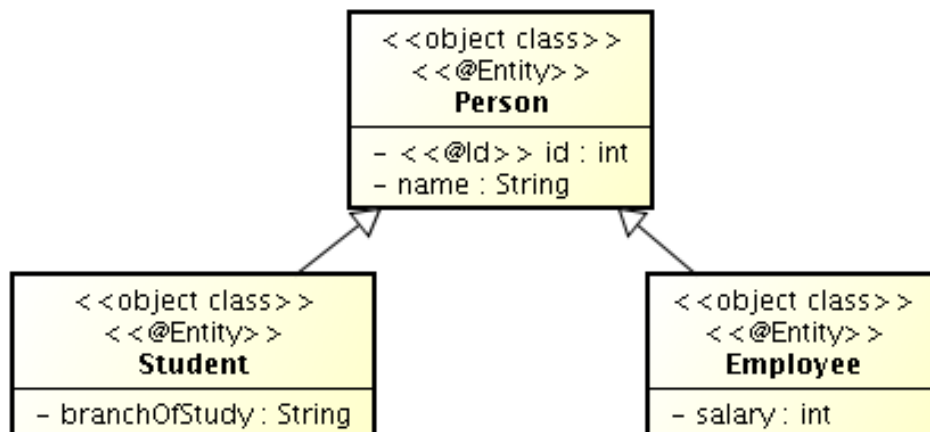

Strategies for inheritance mapping

single table

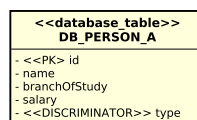

joined

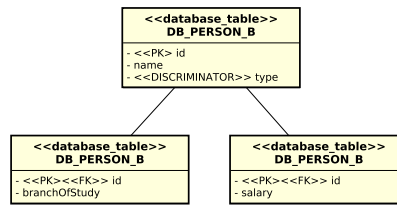
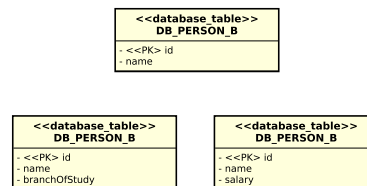

table per class



Inheritance mapping (single-table)

```
@Entity
@Table(name="DB_PERSON_C")
@Inheritance(strategy=InheritanceType.SINGLE_TABLE)*/
@DiscriminationColumn(name="EMP_TYPE")
public abstract class Person {...}

@Entity
@DiscriminatorValue("Emp")
Public class Employee extends Person {...}

@Entity
@DiscriminatorValue("Stud")
Public class Student extends Person {...}
```

Inheritance mapping (joined)

```
@Entity
@Table(name="DB_PERSON_C")
@Inheritance(strategy=InheritanceType.JOINED)
@DiscriminationColumn(name="EMP_TYPE",
    discriminatorType=discriminatorType.INTEGER)
public abstract class Person {...}

@Entity
@Table(name="DB_EMPLOYEE_C")
@DiscriminatorValue("1")
public class Employee extends Person {...}

@Entity
@Table(name="DB_STUDENT_C")
@DiscriminatorValue("2")
public class Student extends Person {...}
```

Inheritance mapping (table-per-class)

```
@Entity
@Inheritance(strategy=InheritanceType.TABLE_PER_CLASS)
public abstract class Person { ... }

@Entity
@Table(name="DB_EMPLOYEE_C")
@AttributeOverride(name="name", column=@Column(name="FULLNAME"))
public class Employee extends Person { ... }

@Entity
@Table(name="DB_STUDENT_C")
public class Student extends Person { ... }
```

7 Summary

Summary

Don't forget!

- JPA 2 is an ORM API in Jakarta EE (Java EE)
- JPA 2 is a must-know for JakartaEE developers
- good conceptual model is a **key to model maintainability**, then comes JPA ...

And the next week ?

- Spring

THANK YOU