

**Curvature-Constrained Data Collection Planning
Dubins Traveling Salesman Problem with Neighborhoods (DTSPN)
and
Dubins Orienteering Problem with Neighborhoods (DOPN)**

Jan Faigl

Department of Computer Science
Faculty of Electrical Engineering
Czech Technical University in Prague

Lecture 07

Robotic Exploration and Data Collection Planning



Overview of the Lecture

- Part 1 – Curvature-Constrained Data Collection Planning
 - Dubins Vehicle and Dubins Planning
 - Dubins Touring Problem (DTP)
 - Dubins Traveling Salesman Problem
 - Dubins Traveling Salesman Problem with Neighborhoods
 - Dubins Orienteering Problem
 - Dubins Orienteering Problem with Neighborhoods
 - Planning in 3D – Examples and Motivations



Part I

Part 1 – Curvature-Constrained Data Collection Planning



Outline

- Dubins Vehicle and Dubins Planning
- Dubins Touring Problem (DTP)
- Dubins Traveling Salesman Problem
- Dubins Traveling Salesman Problem with Neighborhoods
- Dubins Orienteering Problem
- Dubins Orienteering Problem with Neighborhoods
- Planning in 3D – Examples and Motivations



Motivation – Surveillance Missions with Aerial Vehicles

- Provide **curvature-constrained** path to collect the most valuable measurements with shortest possible path/time or under limited travel budget.

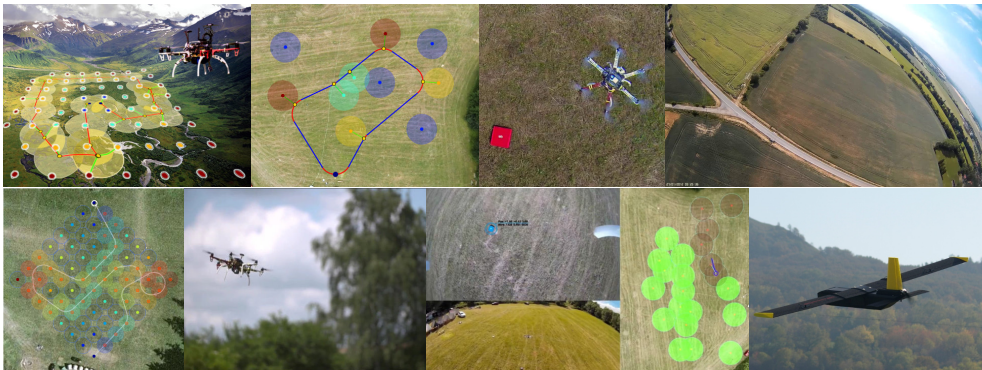

- Formulated as routing problems with Dubins vehicle:
 - **Dubins Traveling Salesman Problem with Neighborhoods;**
 - **Dubins Orienteering Problem with Neighborhoods.**



Dubins Vehicle

- Non-holonomic vehicle such as car-like or aircraft can be modeled as Dubins vehicle:
 - Constant forward velocity;
 - Limited minimal turning radius ρ ;
 - Vehicle state is represented by a triplet $q = (x, y, \theta)$, where
 - Position is $(x, y) \in \mathbb{R}^2$, vehicle heading is $\theta \in \mathbb{S}^1$, and thus $q \in SE(2)$.

The vehicle motion can be described by the equation

$$\begin{bmatrix} \dot{x} \\ \dot{y} \\ \dot{\theta} \end{bmatrix} = v \begin{bmatrix} \cos \theta \\ \sin \theta \\ \frac{u}{\rho} \end{bmatrix}, \quad |u| \leq 1,$$

where u is the control input.

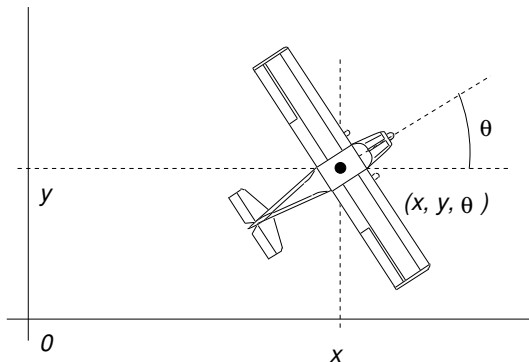

Optimal Maneuvers for Dubins Vehicle

- For two states $q_1 \in SE(2)$ and $q_2 \in SE(2)$ in the environment **without obstacles** $\mathcal{W} = \mathbb{R}^2$, the optimal path connecting q_1 with q_2 can be characterized as one of two main types
 - **CCC** type: **LRL**, **RLR**;
 - **CSC** type: **LSL**, **LSR**, **RSL**, **RSR**;

where S – straight line arc, C – circular arc oriented to left (L) or right (R).

L. E. Dubins (1957) – American Journal of Mathematics

- The optimal paths are called **Dubins maneuvers**.
 - Constant velocity: $v(t) = v$ and minimum turning radius ρ .
 - **Six** types of trajectories connecting any configuration in $SE(2)$. *(Without obstacles)*
 - The control u is according to C and S type one of three possible values $u \in \{-1, 0, 1\}$.



Parametrization of Dubins Maneuvers

- Parametrization of each trajectory phase connecting q_0 with q_f :

$$\{L_\alpha R_\beta L_\gamma, R_\alpha L_\beta R_\gamma, L_\alpha S_d L_\gamma, L_\alpha S_d R_\gamma, R_\alpha S_d L_\gamma, R_\alpha S_d R_\gamma\}$$

for $\alpha \in [0, 2\pi)$, $\beta \in (\pi, 2\pi)$, $d \geq 0$.

Notice the prescribed orientation at q_0 and q_f .

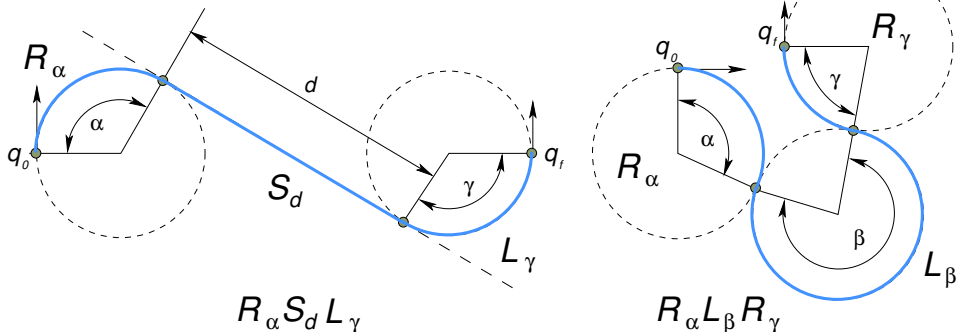

Multi-goal Dubins Path

- Minimal turning radius ρ and constant forward velocity v .
- State of Dubins vehicle is $q = (x, y, \theta)$, $q \in SE(2)$, $(x, y) \in \mathbb{R}^2$ and $\theta \in \mathbb{S}^1$.

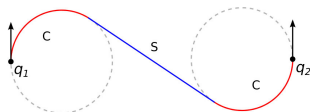
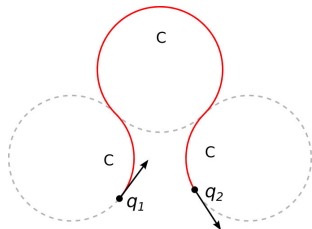

Smooth Dubins path connecting a sequence of locations is also suitable for multi-rotor aerial vehicle.

$$\begin{bmatrix} \dot{x} \\ \dot{y} \\ \dot{\theta} \end{bmatrix} = v \begin{bmatrix} \cos \theta \\ \sin \theta \\ \frac{u}{\rho} \end{bmatrix}$$

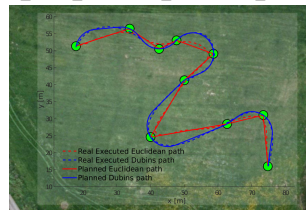

- Optimal path connecting $q_1 \in SE(2)$ and $q_2 \in SE(2)$ consists only of straight line arcs and arcs with the maximal curvature, i.e., two types of maneuvers CCC and CSC and the solution can be found analytically.

(Dubins, 1957)

- In **multi-goal Dubins path planning**, we need to solve the underlying TSP.



Difficulty of Dubins Vehicle in the Solution of the TSP

- For the minimal turning radius ρ , the **optimal path** connecting $\mathbf{q}_1 \in SE(2)$ and $\mathbf{q}_2 \in SE(2)$ can be found analytically.

L. E. Dubins (1957) – American Journal of Mathematics

- Two types of optimal Dubins maneuvers: CSC and CCC.
- The length of the optimal maneuver \mathcal{L} has a closed-form solution.
 - It is **piecewise-continuous function**; *Can be computed in less than 0.5 μ s*
 - (continuous for $\|(\mathbf{p}_1, \mathbf{p}_2)\| > 4\rho$).

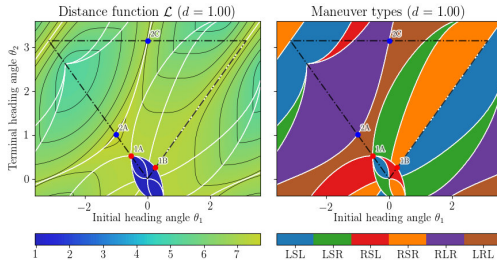
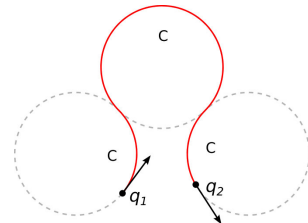
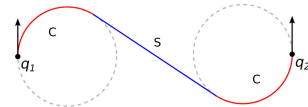
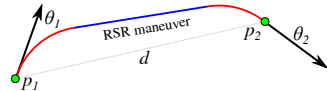

Dubins Traveling Salesman Problem (DTSP)

- Determine (closed) shortest Dubins path visiting each $\mathbf{p}_i \in \mathbb{R}^2$ of the given set of n locations $P = \{\mathbf{p}_1, \dots, \mathbf{p}_n\}$.

1. Permutation $\Sigma = (\sigma_1, \dots, \sigma_n)$ of visits (sequencing).

Combinatorial optimization

2. Headings $\Theta = \{\theta_{\sigma_1}, \theta_{\sigma_2}, \dots, \theta_{\sigma_n}\}$, $\theta_i \in [0, 2\pi)$, for $\mathbf{p}_{\sigma_i} \in P$.

Continuous optimization

- **DTSP** is an optimization problem over all possible **sequences** Σ and **headings** Θ at the states $(\mathbf{q}_{\sigma_1}, \mathbf{q}_{\sigma_2}, \dots, \mathbf{q}_{\sigma_n})$ such that

$$\mathbf{q}_{\sigma_i} = (\mathbf{p}_{\sigma_i}, \theta_{\sigma_i}), \mathbf{p}_{\sigma_i} \in P$$

$$\text{minimize}_{\Sigma, \Theta} \sum_{i=1}^{n-1} \mathcal{L}(\mathbf{q}_{\sigma_i}, \mathbf{q}_{\sigma_{i+1}}) + \mathcal{L}(\mathbf{q}_{\sigma_n}, \mathbf{q}_{\sigma_1}) \quad \text{where}$$

$$\text{subject to} \quad \mathbf{q}_i = (\mathbf{p}_i, \theta_i) \quad i = 1, \dots, n,$$

$\mathcal{L}(\mathbf{q}_{\sigma_i}, \mathbf{q}_{\sigma_j})$ is the length of Dubins path between \mathbf{q}_{σ_i} and \mathbf{q}_{σ_j} .

The continuous domain of the heading angles is similar to the regions in the TSPN-like problem formulations.

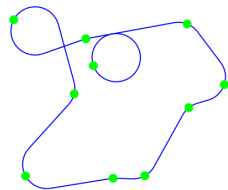
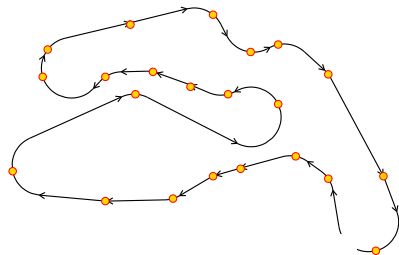

Challenges of the Dubins Traveling Salesman Problem

- The key difficulty of the DTSP is that the path length mutually depends on

- Order of the visits to the locations;
- Headings at the target locations.

We need the sequence to determine headings, but headings may influence the sequence.

- The Dubins TSP is **sequence dependent problem**.
- Two fundamental approaches can be found in literature.

1. **Decoupled** approach based on a given sequence of the locations, e.g., found by a solution of the Euclidean TSP.
2. **Sampling-based** approach with sampling of the headings at the locations into discrete sets of values and considering the problem as the variant of the **Generalized TSP**.

Besides, further approaches are

- Genetic and memetic techniques (evolutionary algorithms);
- Unsupervised learning based approaches.

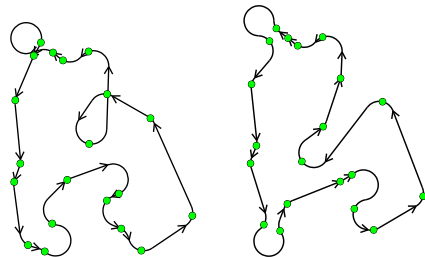

Existing Approaches to the DTSP(N)

■ Heuristic (decoupled & evolutionary) approaches

- *Savla et al., 2005*
- *Ma and Castanon, 2006*
- *Macharet et al., 2011*
- *Macharet et al., 2012*
- *Ny et al., 2012*
- *Yu and Hang, 2012*
- *Macharet et al., 2013*
- *Zhant et al., 2014*
- *Macharet and Campost, 2014*
- *Váňa and Faigl, 2015*
- *Isaiah and Shima, 2015*
-

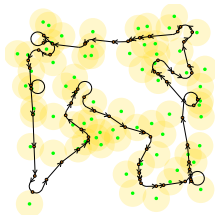
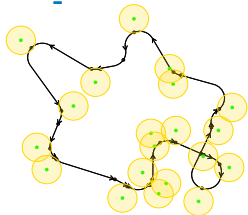

■ Sampling-based approaches

- *Obermeyer, 2009*
- *Oberlin et al., 2010*
- *Macharet et al., 2016*

■ Convex optimization

- (Only if the locations are far enough)
- *Goac et al., 2013*

■ Lower bound for the DTSP

- Dubins Interval Problem (DIP)
- *Manyam et al., 2016*
- DIP-based inform sampling
- *Váňa and Faigl, 2017*

■ Lower bound for the DTSPN

- Using Generalized DIP (GDIP)
- *Váňa and Faigl, 2018, 2020*



Planning with Dubins Vehicle – Summary

- The optimal path connecting two configurations can be found analytically.
E.g., for UAVs that usually operates in environment without obstacles.
- Dubins maneuvers can also be used in randomized-sampling based motion planners, such as RRT, in the control based sampling.
- The Dubins vehicle model can be considered in the multi-goal path planning such as surveillance, inspection or monitoring missions to periodically visits given target locations (areas).

- **Dubins Touring Problem (DTP)**

Given a sequence of locations, what is the shortest path visting the locations, i.e., what are the headings of the vehicle at the locations.

- **Dubins Traveling Salesman Problem (DTSP)**

Given a set of locations, what is the shortest Dubins path that visits each location exactly once and returns to the origin location.

- **Dubins Orienteering Problem (DOP)**

Given a set of locations, each with associated reward, what is Dubins path visting the most rewarding locations and not exceeding the given travel budget.



Outline

- Dubins Vehicle and Dubins Planning
- **Dubins Touring Problem (DTP)**
- Dubins Traveling Salesman Problem
- Dubins Traveling Salesman Problem with Neighborhoods
- Dubins Orienteering Problem
- Dubins Orienteering Problem with Neighborhoods
- Planning in 3D – Examples and Motivations



Dubins Touring Problem – DTP

- For a sequence of the n waypoint locations $P = (p_1, \dots, p_n)$, $p_i \in \mathbb{R}^2$, the **Dubins Touring Problem (DTP)** stands to determine the **optimal headings** $T = \{\theta_1, \dots, \theta_n\}$ at the waypoints q_i such that

$$\begin{aligned} \text{minimize } \tau \quad & \mathcal{L}(T, P) = \sum_{i=1}^{n-1} \mathcal{L}(q_i, q_{i+1}) + \mathcal{L}(q_n, q_1) \\ \text{subject to} \quad & q_i = (p_i, \theta_i), \quad \theta_i \in [0, 2\pi), \quad p_i \in P, \end{aligned}$$

where $\mathcal{L}(q_i, q_j)$ is the length of Dubins maneuver connecting q_i with q_j .

- The DTP is a **continuous optimization problem**.
- The term $\mathcal{L}(q_n, q_1)$ is for possibly closed tour that can be for example requested in the TSP with Dubins vehicle (Dubins TSP - DTSP).

On the other, the DTP can also be utilized for open paths such as solutions of the OP with Dubins vehicle.

- In some cases, it may be suitable to relax the heading at the first/last location in finding closed tours, and thus solving the DTSP.



Sampling-based Solution of the DTP

- For a closed sequence of the waypoint locations

$$P = (p_1, \dots, p_n).$$

- We can sample possible heading values at each location i into a discrete set of k headings $\Theta^i = \{\theta_1^i, \dots, \theta_k^i\}$, and create a graph of all possible Dubins maneuvers.

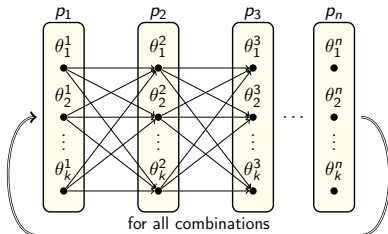

- For a set of heading samples, the optimal solution can be found by a forward search of the graph in $O(nk^3)$.

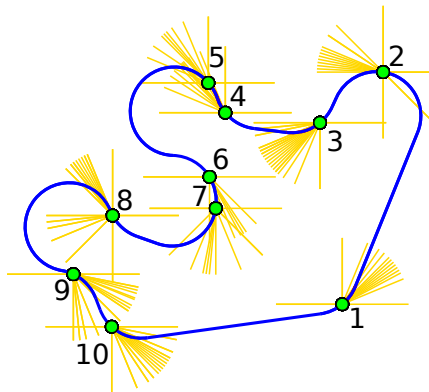

For open sequence we do not need to evaluate all possible initial headings, and the complexity is $O(nk^2)$.

- The problem is to determine the most suitable heading samples.**



Example of Heading Sampling – Uniform vs. Informed

Uniform sampling

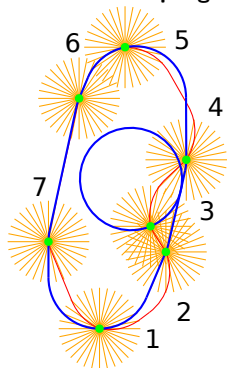

$N = 224$, $T_{cpu} = 128$ ms
 $\mathcal{L} = 19.8$, $\mathcal{L}_U = 13.8$

Informed sampling

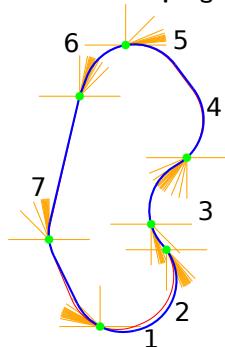

$N = 128$, $T_{cpu} = 76$ ms
 $\mathcal{L} = 14.4$, $\mathcal{L}_U = 14.2$

- N is the total number of samples, for example 32 samples per waypoint for uniform sampling.
- \mathcal{L} is the length of the tour (blue) and \mathcal{L}_U is the lower bound path (red) determined as a solution of the **Dubins Interval Problem (DIP)**.



Dubins Interval Problem (DIP)

- **Dubins Interval Problem (DIP)** is a generalization of Dubins maneuvers to the shortest path connecting two points p_i and p_j .
- In the DIP, the leaving interval Θ_i at p_i and the arrival interval Θ_j at p_j are considered (not a single heading value).
- The optimal solution can be found analytically.

Manyam et al. (2015)

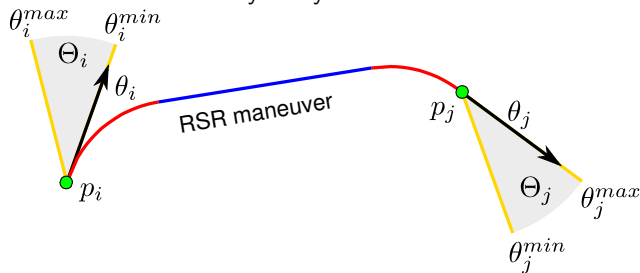

- Solution of the DIP is a tight lower bound for the DTP.
- Solution of the DIP is not a feasible solution of the DTP.

Notice, for $\Theta_i = \Theta_j = \langle 0, 2\pi \rangle$ the optimal maneuver for DIP is a straight line segment.



Lower Bound of the DTP

- For a discrete set of heading intervals $\mathcal{H} = \{H_1, \dots, H_n\}$, where $H_i = \{\Theta_i^1, \Theta_i^2, \dots, \Theta_i^{k_i}\}$, a similar graph as for the DTP can be constructed with the edge cost determined by the solution of the associated DIP.

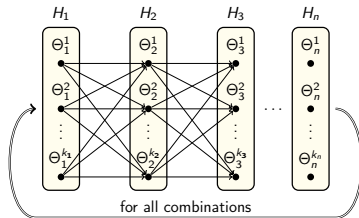

- The forward search of the graph with dense samples provides a **tight lower bound on the optimal solution cost of the DTP**.

Manyam and Rathinam, 2015

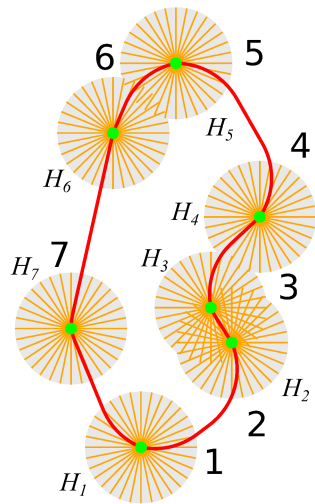

Lower Bound and Feasible Solution of the DTP

- The arrival and departure angles may not be the same.

The lower bound solution is not a feasible solution of the DTP.

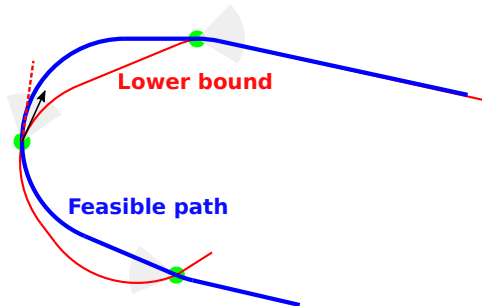

- **DTP solution** – use any particular heading of each interval in the lower bound solution.



The DIP-based Sampling of Headings in the DTP

- Using heading intervals for a sequence of waypoints and a solution of the DIP, we can determine **lower bound** of the DTP using the forward search graph as for the DTP.
- The ratio between the lower bound and feasible solution of the DTP provides an estimation of the solution quality.

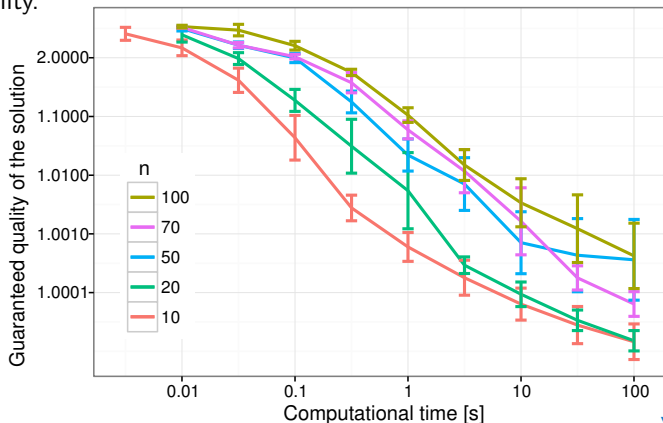

Vána and Faigl (2016)



Iteratively-Refined Informed Sampling (IRIS) of Headings in the Solution of the DTP

- Iterative refinement of the heading intervals \mathcal{H} up to the angular resolution ϵ_{req} .
- The angular resolution is gradually increased for the most promising intervals.
- **refineDTP** – divide the intervals of the lower bound solution.
- **solveDTP** – solve the DTP using the heading from the refined intervals.
- It simultaneously provides **feasible** and **lower bound** solutions of the DTP.
 - The lower bound provides a tight estimation of the solution quality.*
- The first solution is provided very quickly – **any-time algorithm**.

Algorithm 1: Iterative Informed Sampling-based DTP Algorithm

Input: P – Target locations to be visited
Input: ϵ_{req} – Requested angular resolution
Input: α_{req} – Requested quality of the solution
Output: T – A tour visiting the targets

```

 $\epsilon \leftarrow 2\pi$  // initial angular resolution;
 $\mathcal{H} \leftarrow \text{createIntervals}(P, \epsilon)$  // initial intervals;
 $\mathcal{L}_L \leftarrow 0$  // init lower bound;
 $\mathcal{L}_U \leftarrow \infty$  // init upper bound;
while  $\epsilon > \epsilon_{req}$  and  $\mathcal{L}_U / \mathcal{L}_L > \alpha_{req}$  do
  |  $\epsilon \leftarrow \epsilon / 2$ ;
  |  $(\mathcal{H}, \mathcal{L}_L) \leftarrow \text{refineDTP}(P, \epsilon, \mathcal{H})$ ;
  |  $(T, \mathcal{L}_U) \leftarrow \text{solveDTP}(P, \mathcal{H})$ ;
end
return  $T$ ;

```

Faigl, J., Váňa, P., Saska, M., Báča, T., and Spurný, V.:
On solution of the Dubins touring problem, **ECMR**, 2017.



Uniform vs Informed Sampling

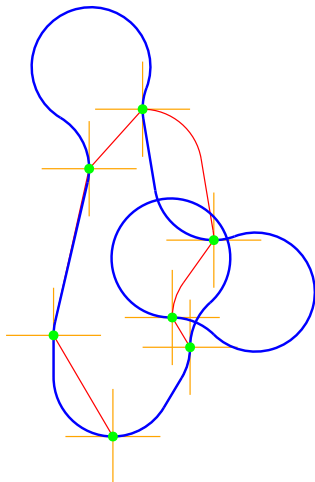

$$\epsilon = 2\pi/4, N = 28, T_{\text{CPU}} = 8 \text{ ms}$$

$$\mathcal{L} = 27.9, \mathcal{L}_U = 13.2$$

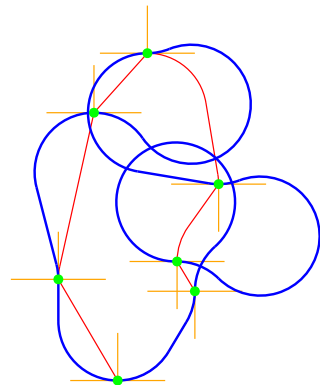

$$\epsilon = 2\pi/4, N = 21, T_{\text{CPU}} = 8 \text{ ms}$$

$$\mathcal{L} = 29.9, \mathcal{L}_U = 13.2$$



Uniform vs Informed Sampling

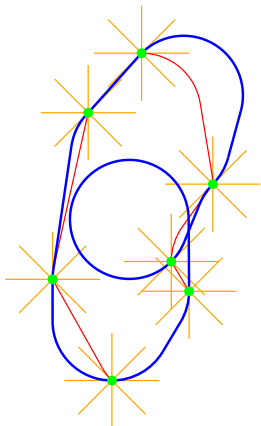

$\epsilon = 2\pi/8$, $N = 56$, $T_{\text{CPU}} = 16$ ms
 $\mathcal{L} = 20.8$, $\mathcal{L}_U = 13.2$

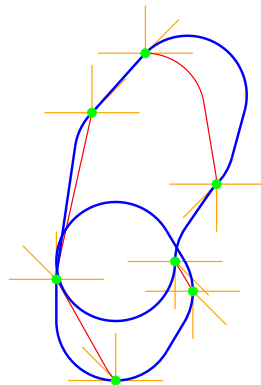

$\epsilon = 2\pi/8$, $N = 28$, $T_{\text{CPU}} = 20$ ms
 $\mathcal{L} = 21.0$, $\mathcal{L}_U = 13.2$



Uniform vs Informed Sampling

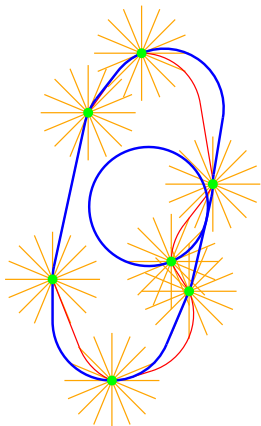

$\epsilon = 2\pi/16$, $N = 112$, $T_{\text{CPU}} = 40$ ms
 $\mathcal{L} = 20.3$, $\mathcal{L}_U = 13.5$

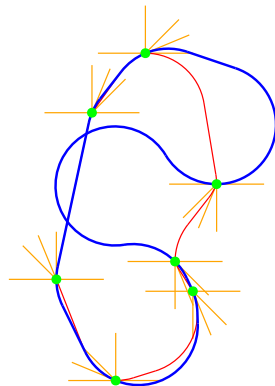

$\epsilon = 2\pi/16$, $N = 35$, $T_{\text{CPU}} = 24$ ms
 $\mathcal{L} = 20.1$, $\mathcal{L}_U = 13.5$



Uniform vs Informed Sampling

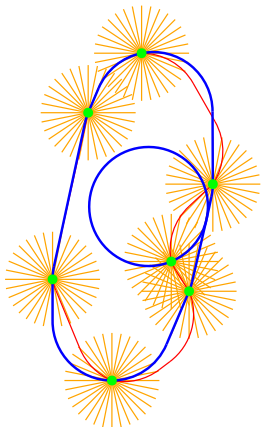

$\epsilon = 2\pi/32$, $N = 224$, $T_{\text{CPU}} = 140$ ms
 $\mathcal{L} = 19.8$, $\mathcal{L}_U = 13.8$

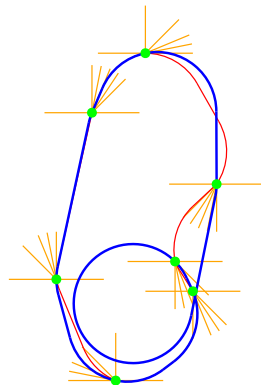

$\epsilon = 2\pi/32$, $N = 44$, $T_{\text{CPU}} = 32$ ms
 $\mathcal{L} = 19.9$, $\mathcal{L}_U = 13.8$



Uniform vs Informed Sampling

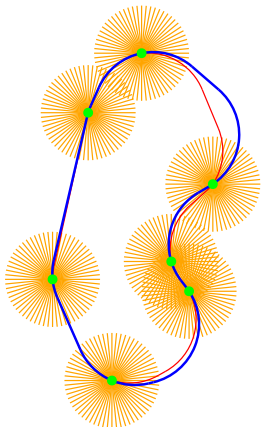

$\epsilon = 2\pi/64$, $N = 448$, $T_{\text{CPU}} = 456$ ms
 $\mathcal{L} = 14.5$, $\mathcal{L}_U = 14.5$

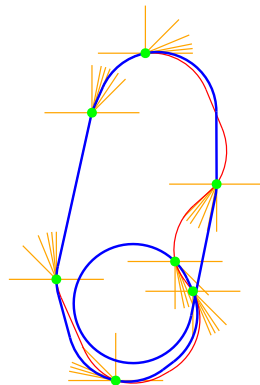

$\epsilon = 2\pi/64$, $N = 51$, $T_{\text{CPU}} = 48$ ms
 $\mathcal{L} = 19.9$, $\mathcal{L}_U = 13.9$



Uniform vs Informed Sampling

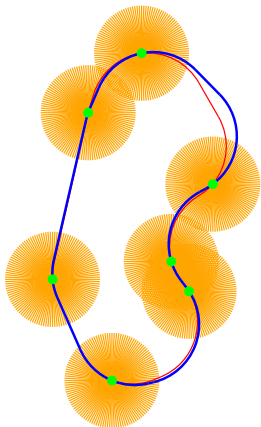

$\epsilon = 2\pi/128$, $N = 896$, $T_{\text{CPU}} = 1620$ ms
 $\mathcal{L} = 14.5$, $\mathcal{L}_U = 14.5$

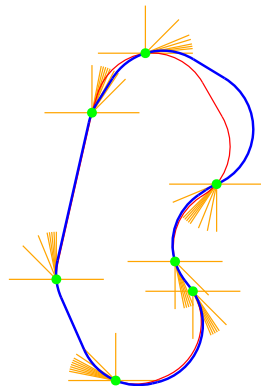

$\epsilon = 2\pi/128$, $N = 70$, $T_{\text{CPU}} = 60$ ms
 $\mathcal{L} = 14.8$, $\mathcal{L}_U = 14.1$



Uniform vs Informed Sampling

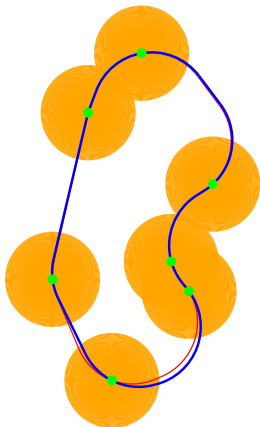

$\epsilon = 2\pi/256$, $N = 1792$, $T_{\text{CPU}} = 6784$ ms
 $\mathcal{L} = 14.4$, $\mathcal{L}_U = 14.3$

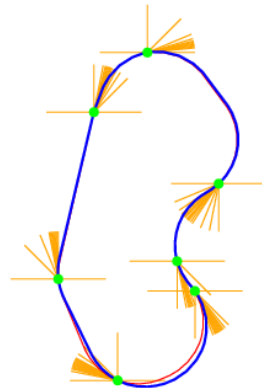

$\epsilon = 2\pi/256$, $N = 100$, $T_{\text{CPU}} = 88$ ms
 $\mathcal{L} = 14.4$, $\mathcal{L}_U = 14.3$



Results and Comparison with Uniform Sampling

- Random instances of the DTSP with a sequence of visits to the targets determined as a solution of the Euclidean TSP.
- The waypoints placed in a squared bounding box with the side $s = (\rho\sqrt{n})/d$ for the $\rho = 1$ and density $d = 0.5$.

Density of target locations influence the solution!

Quality of solution for increasing n

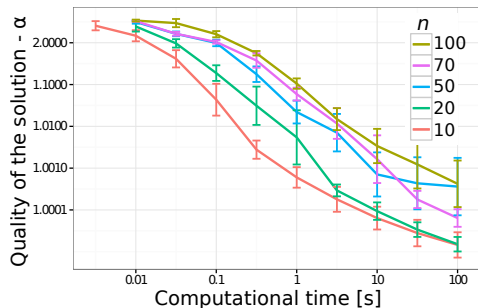

Comparison with the uniform sampling

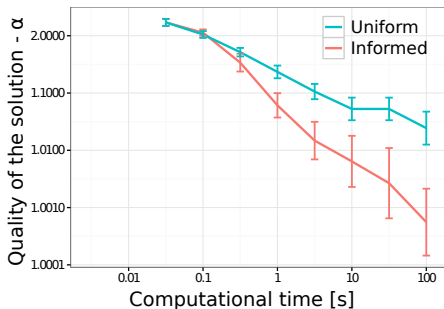

- The informed sampling-based approach provides solutions up to 0.01% from the optima.
- A solution of the DTP is a fundamental building block for **routing problems with Dubins vehicle**.



Outline

- Dubins Vehicle and Dubins Planning
- Dubins Touring Problem (DTP)
- **Dubins Traveling Salesman Problem**
- Dubins Traveling Salesman Problem with Neighborhoods
- Dubins Orienteering Problem
- Dubins Orienteering Problem with Neighborhoods
- Planning in 3D – Examples and Motivations



Dubins Traveling Salesman Problem (DTSP)

1. Determine a closed shortest Dubins path visiting each location $p_i \in P$ of the given set of n locations $P = \{p_1, \dots, p_n\}$, $p_i \in \mathbb{R}^2$.
2. Permutation $\Sigma = (\sigma_1, \dots, \sigma_n)$ of visits.
Sequencing part of the problem
3. Headings $\Theta = \{\theta_{\sigma_1}, \theta_{\sigma_2}, \dots, \theta_{\sigma_n}\}$ for $p_{\sigma_i} \in P$.
Continuous optimization

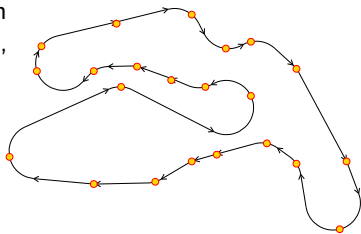

- **DTSP** is an optimization problem over all possible **permutations** Σ and **headings** Θ in the states $(q_{\sigma_1}, q_{\sigma_2}, \dots, q_{\sigma_n})$ such that $q_{\sigma_i} = (p_{\sigma_i}, \theta_{\sigma_i})$

$$\begin{aligned} \text{minimize}_{\Sigma, \Theta} \quad & \sum_{i=1}^{n-1} \mathcal{L}(q_{\sigma_i}, q_{\sigma_{i+1}}) + \mathcal{L}(q_{\sigma_n}, q_{\sigma_1}) \\ \text{subject to} \quad & q_i = (p_i, \theta_i) \quad i = 1, \dots, n, \end{aligned}$$

where $\mathcal{L}(q_{\sigma_i}, q_{\sigma_j})$ is the length of Dubins path between q_{σ_i} and q_{σ_j} .



Decoupled Solution of the DTSP – Alternating Algorithm

Alternating Algorithm (AA) provides a solution of the DTSP for an **even** number of targets n .

Savla, K., Frazzoli, E., Bullo, F.: *On the point-to-point and traveling salesperson problems for Dubins' vehicle*, IEE American Control Conference, 2005.

1. Solve the related Euclidean TSP.
 - Relaxed motion constraints.*
2. Establish headings for even edges using straight line segments.
3. Determine optimal maneuvers for odd edges using the analytical form for Dubins maneuvers.
 - Headings are known.*

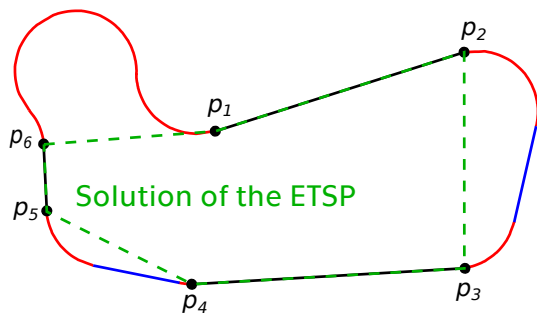

Courtesy of P. Váňa



DTSP with the Given Sequence of the Visits to the Targets

- If the sequence of the visits Σ to the target locations is given.
- the problem is to determine the optimal heading at each location.
- and the problem becomes the **Dubins Touring Problem (DTP)**.
- Let for each location $g_i \in G$ sample possible heading to k values, i.e., for each g_i the set of headings be $h_i = \{\theta_1^1, \dots, \theta_1^k\}$.
- Since Σ is given, we can construct a graph connecting two consecutive locations in the sequence by all possible headings.
- For such a graph and particular headings $\{h_1, \dots, h_n\}$, we can find an optimal headings and thus, **the optimal solution of the DTP**.



DTSP as a Solution of the DTP

The first layer is duplicated layer to support the forward search method

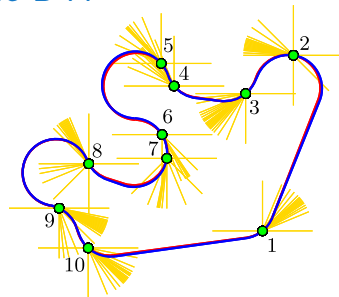
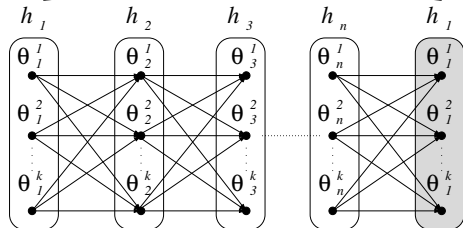

- The edge cost corresponds to the length of Dubins maneuver.
- Better solution of the DTP can be found for more samples, which will also improve the DTSP but only for the given sequence.

Two questions arise for a practical solution of the DTP.

- **How to sample the headings?** More samples makes finding solution more demanding.

We need to sample the headings in a "smart" way, i.e., guided sampling using lower bound of the DTP?

- **What is the solution quality?** Is there a tight lower bound?

Yes, the lower bound can be computed as a solution of the Dubins Interval Problem (DIP).



DTP Solver in Solution of the DTSP

- The solution of the DTP can be used to solve DTSP for the given sequence of the waypoints.

E.g., determined as a solution of the Euclidean TSP as in the Alternating Algorithm.

- Comparison with the Alternating Algorithm (AA), Local Iterative Optimization (LIO), and Memetic algorithm.

AA – Savla et al., 2005, LIO – Váňa & Faigl, 2015, Memetic – Zhang et al. 2014

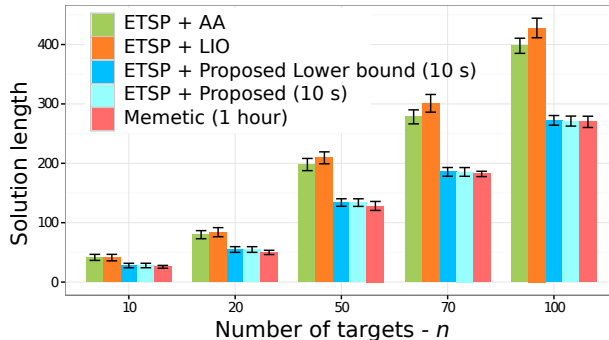

DTSP – Sampling-based Approach

- Sampled heading values can be directly utilized to find the sequence as a solution of the **Generalized Traveling Salesman Problem (GTSP)**.

Notice For Dubins vehicle, it is the Generalized Asymmetric TSP (GATSP).

The problem is to determine a shortest tour in a graph that visits all specified subsets of the graph's vertices.

The TSP is a special case of the GTSP when each subset to be visited consists just a single vertex.

- GATSP \rightarrow ATSP;

Noon and Bean (1991)

- ATSP can be solved by LKH;
- ATSP \rightarrow TSP, which can be solved optimally, e.g., by Concorde.

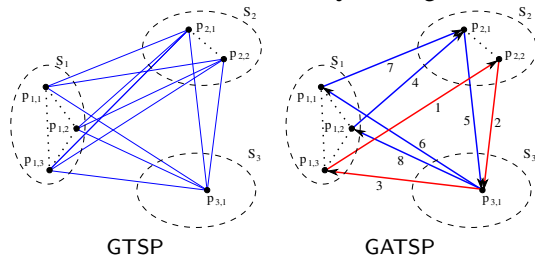

DTSP – Evolutionary Approach with Surrogate Model

- Use standard genetic operators with tournament selection and OX1 crossover method.
- The population is evaluated using learned surrogate model based on multi-layer perceptron.
- The surrogate model estimates solution cost of candidate sequences (instances of the DTP).
- Massive speedup of the evaluation yields improved solutions and scalability.

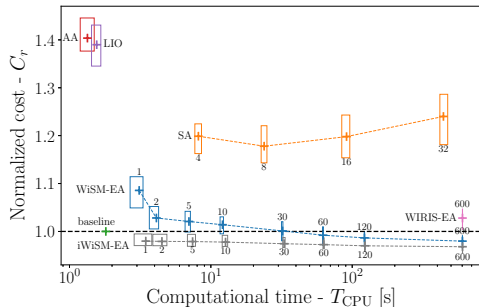

Instances with low density d and $n = 100$ target locations

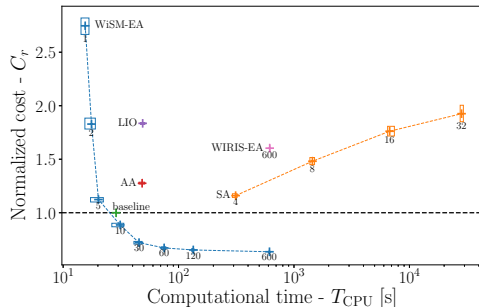

Instances with high density d and $n = 500$ target locations

Drchal, J., Váňa, P., and Faigl, J.: *WiSM: Windowing Surrogate Model for Evaluation of Curvature-Constrained Tours with Dubins vehicle*, IEEE Transactions on Cybernetics, 52(2):1302–1311, 2022.



Outline

- Dubins Vehicle and Dubins Planning
- Dubins Touring Problem (DTP)
- Dubins Traveling Salesman Problem
- **Dubins Traveling Salesman Problem with Neighborhoods**
- Dubins Orienteering Problem
- Dubins Orienteering Problem with Neighborhoods
- Planning in 3D – Examples and Motivations



Dubins Traveling Salesman Problem with Neighborhoods

- In surveillance planning, it may be required to visit a set of target regions $\mathbf{G} = \{R_1, \dots, R_n\}$ by Dubins vehicle.
- Then, for each target region R_i , we have to determine a particular point of the visit $p_i \in R_i$ and DTSP becomes the **Dubins Traveling Salesman Problem with Neighborhoods (DTSPN)**.
In addition to Σ and headings Θ , waypoint locations P have to be determined.
- DTSPN is an optimization problem over all permutations Σ , headings $\Theta = \{\theta_{\sigma_1}, \dots, \theta_{\sigma_n}\}$ and points $P = (p_{\sigma_1}, \dots, p_{\sigma_n})$ for the states $(q_{\sigma_1}, \dots, q_{\sigma_n})$ such that $q_{\sigma_i} = (p_{\sigma_i}, \theta_{\sigma_i})$ and $p_{\sigma_i} \in R_{\sigma_i}$:

$$\begin{aligned} \text{minimize}_{\Sigma, \Theta, P} \quad & \sum_{i=1}^{n-1} \mathcal{L}(q_{\sigma_i}, q_{\sigma_{i+1}}) + \mathcal{L}(q_{\sigma_n}, q_{\sigma_1}) \\ \text{subject to} \quad & q_i = (p_i, \theta_i), p_i \in R_i \quad i = 1, \dots, n. \end{aligned}$$

- $\mathcal{L}(q_{\sigma_i}, q_{\sigma_j})$ is the length of the shortest possible Dubins maneuver connecting the states q_{σ_i} and q_{σ_j} .



DTSPN – Approches and Examples of Solution

- **Decoupled approach** for which a sequence of visits to the regions can be found as a solution of the ETSP(N).
- **Sampling-based approach** and formulation as the GATSP.
 - Clusters of sampled waypoint locations each with sampled possible heading values.
- **Decoupled** solution of the sequence of visits and **sampling waypoint locations** and **sampling heading angles** for each such location sample.
- **Soft-computing** techniques such as memetic algorithms.
- **Unsupervised learning** techniques.

Váňa and Faigl (IROS 2015), Faigl and Váňa (ICANN 2016, IJCNN 2017)

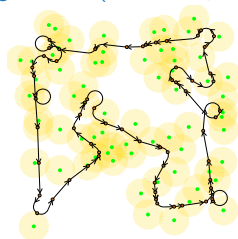
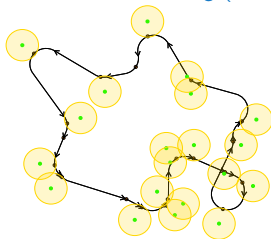
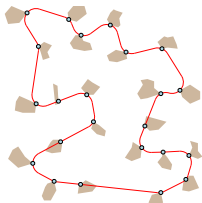

- Similarly to the lower bound of the DTSP based on the **Dubins Interval Problem** (DIP) a lower bound for the DTSPN can be computed using the **Generalized DIP** (GDIP).



DTSPN – Decoupled Sampling-based Approach

1. Determine a sequence of visits to the n target regions as the solution of the ETSP.
2. Sample possible waypoint locations and for each such a location sample possible heading values, e.g., s locations per each region and h heading per each location.
3. Construct a search graph and determine a solution in $O(n(sh)^3)$.
4. An example of the search graph for $n = 6$, $s = 6$, and $h = 6$.

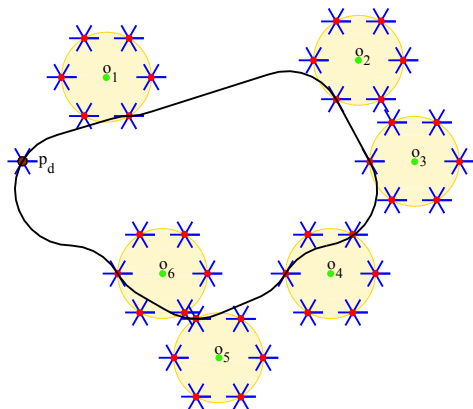
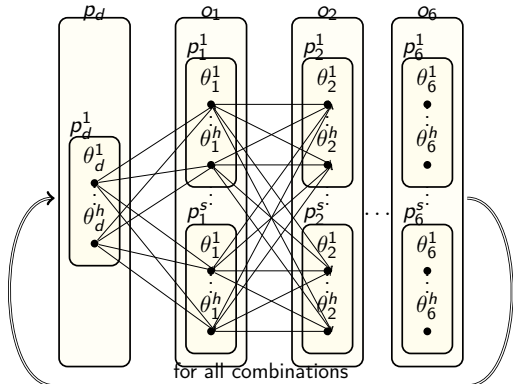

DTSPN – Decoupled with Local Iterative Optimization (LIO)

- Instead of sampling into a discrete set of waypoint locations each with sampled possible headings, we can perform local optimization, e.g., hill-climbing technique.
- At each waypoint location p_i , the heading can be $\theta_i \in [0, 2\pi)$.
- A waypoint location p_i can be parametrized as a point on the boundary of the respective region R_i , i.e., as a parameter $\alpha \in [0, 1)$ measuring a normalized distance on the boundary of R_i .
- The multi-variable optimization is treated independently for each particular variable θ_i and α_i iteratively.

Algorithm 2: Local Iterative Optimization (LIO) for the DTSPN

Data: Input sequence of the goal regions

$\mathbf{G} = (R_{\sigma_1}, \dots, R_{\sigma_n})$, for the permutation Σ

Result: Waypoints $(q_{\sigma_1}, \dots, q_n)$, $q_i = (p_i, \theta_i)$,

$p_i \in \delta R_i$

initialization() // random assignment of $q_i \in \delta R_i$;

while *global solution is improving* **do**

for every $R_i \in \mathbf{G}$ **do**

$\theta_i := \text{optimizeHeadingLocally}(\theta_i)$;

$\alpha_i := \text{optimizePositionLocally}(\alpha_i)$;

$q_i := \text{checkLocalMinima}(\alpha_i, \theta_i)$;

end

end

Váňa, P. and Faigl, J.: *On the Dubins Traveling Salesman Problem with Neighborhoods*, IROS, 2015, pp. 4029–4034.



Lower Bound for the DTSP with Neighborhoods Generalized Dubins Interval Problem

- In the DTSPN, we need to determine the **headings** and also the **waypoint locations**.
- The **Dubins Interval Problem (DIP)** is not sufficient to provide tight lower bound.

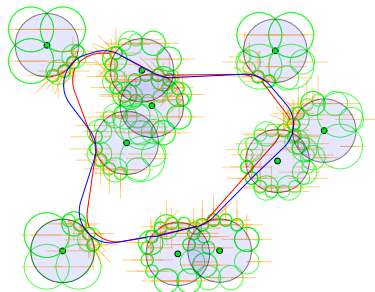
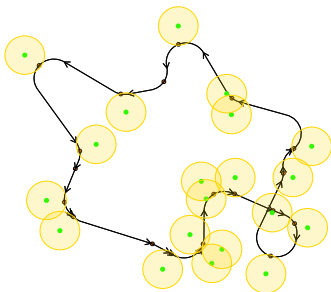

- **Generalized Dubins Interval Problem (GDIP)** can be utilized for the DTSPN similarly as the DIP for the DTSP.

Váňa and Faigl: *Optimal Solution of the Generalized Dubins Interval Problem*, RSS 2018, best student paper finalist.



Generalized Dubins Interval Problem (GDIP)

- Determine the shortest Dubins maneuver connecting P_i and P_j given the angle intervals $\theta_i \in [\theta_i^{\min}, \theta_i^{\max}]$ and $\theta_j \in [\theta_j^{\min}, \theta_j^{\max}]$.

Full problem (GDIP)

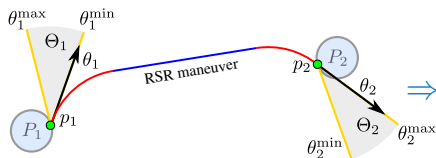

One-side version (OS-GDIP)

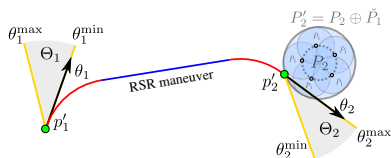

- Optimal solution** – Closed-form expressions for (1–6) and convex optimization (7).

1) S type



2) CS type



3) Cpsi type



7) CCpsi type



4) CSC type



5) CSC type

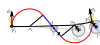

6) CCpsi C type



Average computational time

Problem	Time [μ s]	Ratio
Dubins maneuver	0.4	1.0
DIP	1.1	3.0
GDIP	5.4	14.5

<https://github.com/comrob/gdip>

Vãna, P. and Faigl, J.: *Optimal Solution of the Generalized Dubins Interval Problem Finding the Shortest Curvature-constrained Path Through a Set of Regions*, *Autonomous Robots*, 44(7):1359-1376, 2020.



GDIP-based Informed Sampling for the DTSPN

- Iterative refinement of the neighborhood samples and heading samples.

Resolution: 4

Gap: 69.3 %

Time: 0.079 s

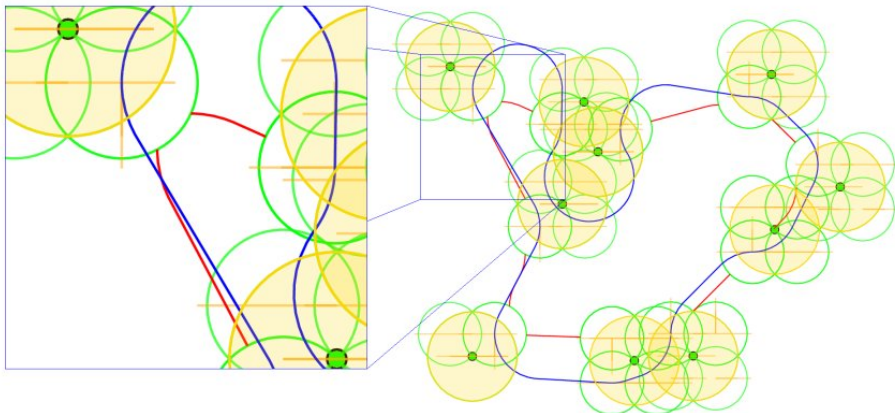

GDIP-based Informed Sampling for the DTSPN

- Iterative refinement of the neighborhood samples and heading samples.

Resolution: 8

Gap: 39.4 %

Time: 0.211 s

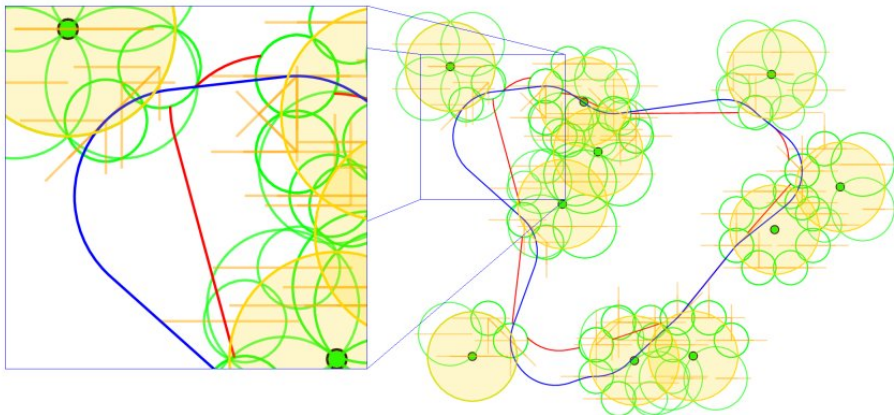

GDIP-based Informed Sampling for the DTSPN

- Iterative refinement of the neighborhood samples and heading samples.

Resolution: 16

Gap: 19.9 %

Time: 0.552 s

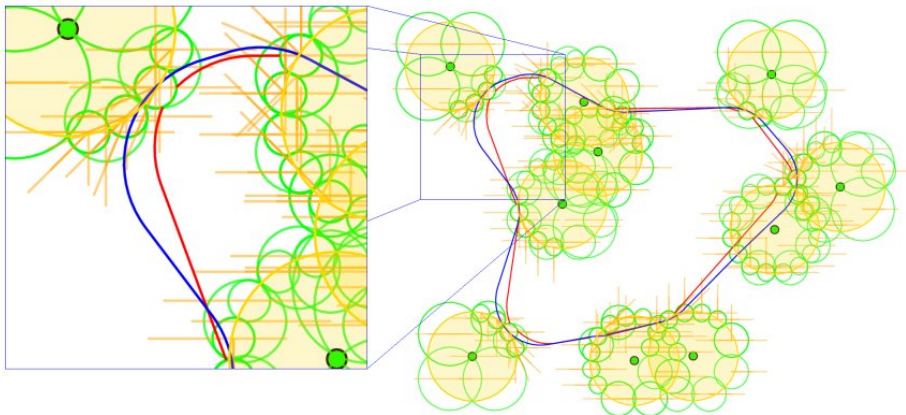

GDIP-based Informed Sampling for the DTSPN

- Iterative refinement of the neighborhood samples and heading samples.

Resolution: 32

Gap: 10.7 %

Time: 1.292 s

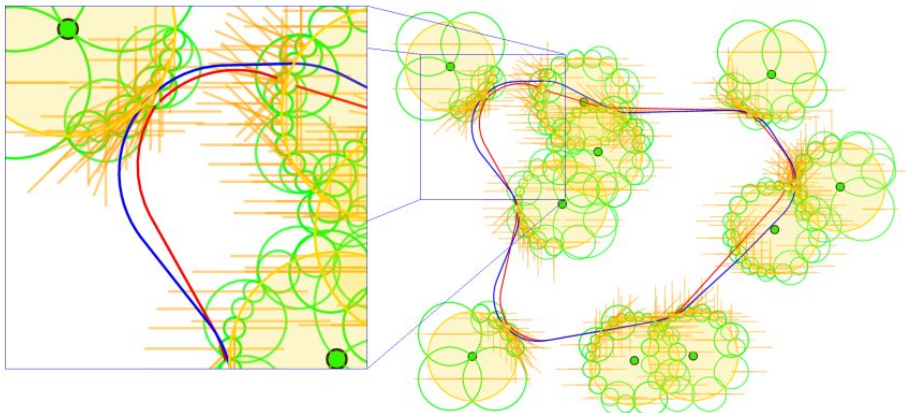

GDIP-based Informed Sampling for the DTSPN

- Iterative refinement of the neighborhood samples and heading samples.

Resolution: 64

Gap: 5.3 %

Time: 3.183 s

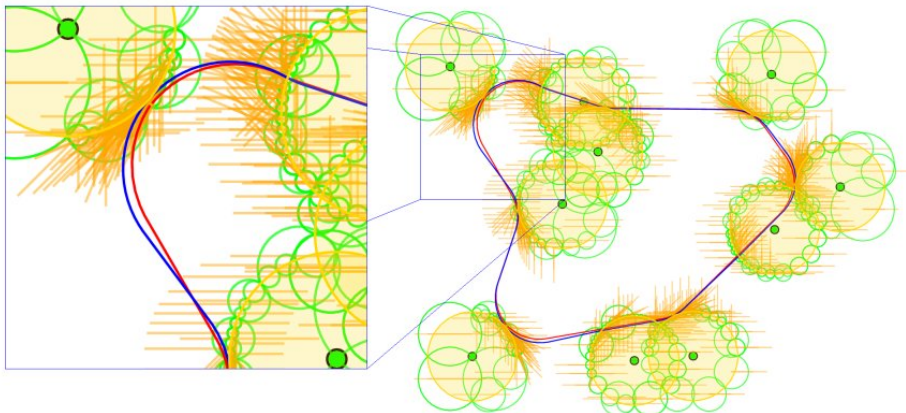

GDIP-based Informed Sampling for the DTSPN

- Iterative refinement of the neighborhood samples and heading samples.

Resolution: 128

Gap: 2.6 %

Time: 8.994 s

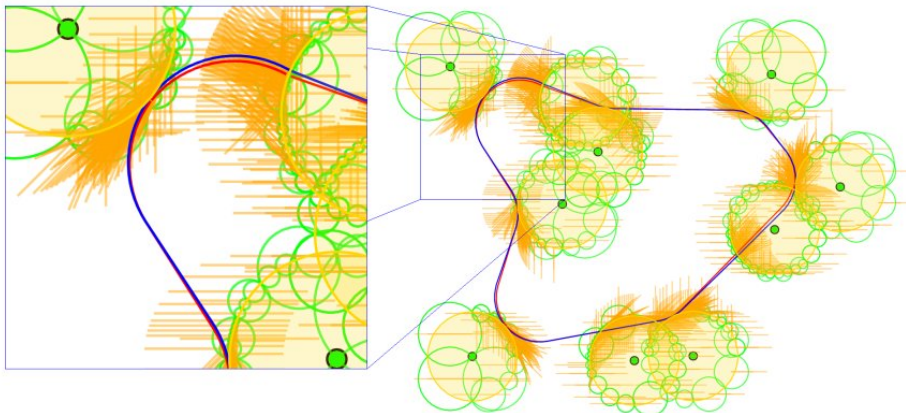

GDIP-based Informed Sampling for the DTSPN

- Iterative refinement of the neighborhood samples and heading samples.

Resolution: 256

Gap: 1.3 %

Time: 33.474 s

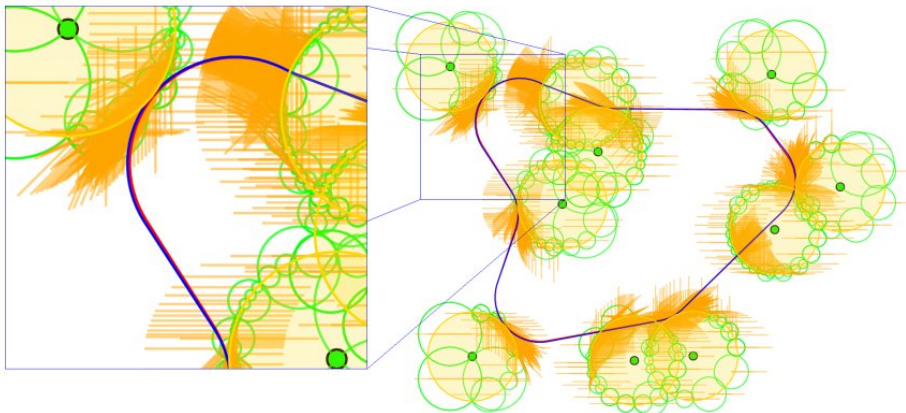

DTSPN – Convergence to the Optimal Solution

- For a given sequence of visits to the target regions (locations).

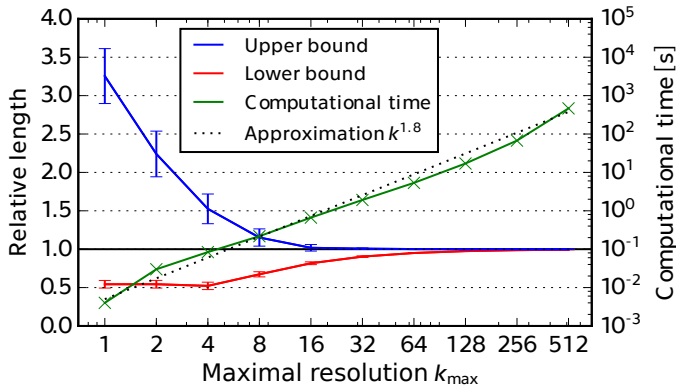
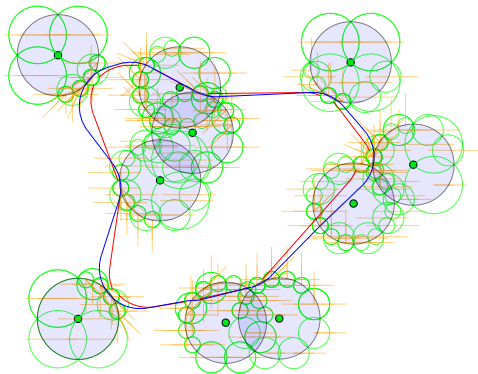

- The algorithm scales linearly with the number of locations.
- Complexity of the algorithm is approximately $\mathcal{O}(nk^{1.8})$.

<https://github.com/comrob/gdip>



Outline

- Dubins Vehicle and Dubins Planning
- Dubins Touring Problem (DTP)
- Dubins Traveling Salesman Problem
- Dubins Traveling Salesman Problem with Neighborhoods
- **Dubins Orienteering Problem**
- Dubins Orienteering Problem with Neighborhoods
- Planning in 3D – Examples and Motivations



Data Collection / Surveillance Planning with Travel Budget

- Visit the most important targets because of limited travel budget.
- The problem can be formulated as the **Orienteering Problem** with Dubins vehicle, a.k.a. **Dubins Orienteering Problem (DOP)**.

Robert Pěnička, Jan Faigl, Petr Váňa and Martin Saska, RA-L 2017

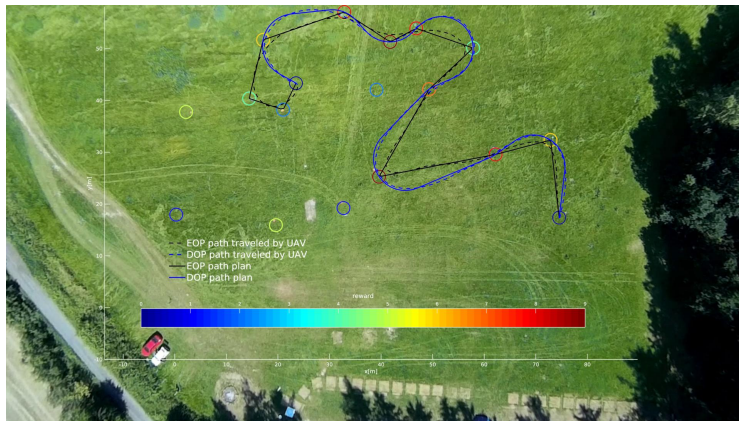

<http://mrs.felk.cvut.cz/icra17dop>



Dubins Orienteering Problem

- Curvature-constrained data collection path respecting the Dubins vehicle model with the minimal turning radius ρ and constant forward velocity v .
- The path is a sequence of waypoints $q_i \in SE(2)$, $q_i = (s_i, \theta_i)$, $s_i \in \mathbb{R}^2$, $\theta_i \in \mathbb{S}^1$.
- In addition to S_k, k, Σ (OP) determine headings $\Theta = (\theta_{\sigma_1}, \dots, \theta_{\sigma_k})$ such that

$$\begin{aligned} & \text{maximize}_{k, S_k, \Sigma} && R = \sum_{i=1}^k r_{\sigma_i} \\ & \text{subject to} && \sum_{i=2}^k \mathcal{L}(q_{\sigma_{i-1}}, q_{\sigma_i}) \leq T_{\max}, \\ & && q_{\sigma_i} = (s_{\sigma_i}, \theta_{\sigma_i}), s_{\sigma_i} \in S, \theta_{\sigma_i} \in \mathbb{S}^1 \\ & && s_{\sigma_1} = s_1, s_{\sigma_k} = s_n \end{aligned}$$

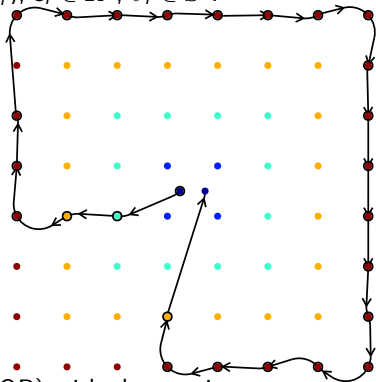

The problem combines discrete combinatorial optimization (OP) with the continuous optimization for **determining the vehicle headings**.



Variable Neighborhood Search (VNS)

- **Variable Neighborhood Search (VNS)** is a general metaheuristic for combinatorial optimization (routing problems).

Hansen, P. and Mladenović, N. (2001): **Variable neighborhood search: Principles and applications**. European Journal of Operational Research.

- The VNS is based on **shake** and **local search** procedures.
 - **Shake** procedure aims to escape from local optima by changing the solution within the neighborhoods $N_{1, \dots, k_{max}}$. *The neighborhoods are particular operators.*
 - **Local search** procedure searches fully specific neighborhoods of the solution using l_{max} predefined operators.



Variable Neighborhood Search (VNS) for the DOP

- The solution is the first k locations of the sequence of all target locations satisfying T_{\max} .

Sevkli Z., Sevilgen F.E.: *Variable Neighborhood Search for the Orienteering Problem*, SCIS, 2006.

- It is an improving heuristics, i.e., an initial solution has to be provided.
- A set of predefined neighborhoods are explored to find a better solution.
- **Shake** – explores the configuration space and escape from a local minima using
 - **Insert** – moves one random element;
 - **Exchange** – exchanges two random elements.
- **Local Search** – optimizes the solution using
 - **Path insert** – moves a random sub-sequence;
 - **Path exchange** – exchanges two random sub-sequences.
- **Randomized VNS** – examines only n^2 changes in the *Local Search* procedure in each iteration.

Insert

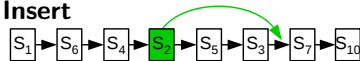

Exchange



Path insert



Path exchange



Evolution of the VNS Solution to the DOP

Initial solution

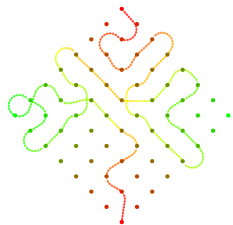

$T_{CPU} = 10.9$ s,
 $\mathcal{L} = 79.6$, $R = 960$

4710th iteration
(4th improvement)

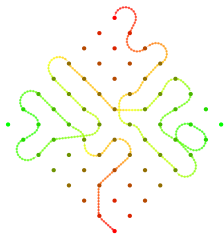

$T_{CPU} = 144.8$ s,
 $\mathcal{L} = 79.7$, $R = 990$

4790th iteration
(12th improvement)

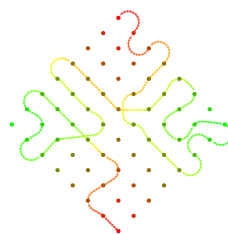

$T_{CPU} = 147.3$ s,
 $\mathcal{L} = 79.3$, $R = 1008$

5560th iteration
(16th improvement)

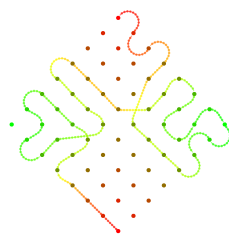

$T_{CPU} = 170.0$ s,
 $\mathcal{L} = 79.1$, $R = 1050$



Possible Solutions of the Dubins Orienteering Problem

1. Solve the Euclidean OP (EOP) and then determine Dubins path.

The final path may exceed the budget and the vehicle can miss the locations because of motion control.

2. Directly solve the **Dubins Orienteering Problem (DOP)** such as

- Sample possible heading values and use Variable Neighborhood Search (VNS);
Pěnička, R., Faigl, J., Váňa, P., and Saska, M.: *Dubins Orienteering Problem*, IEEE Robotics and Automation Letters, 2(2):1210–1217, 2017.
- Unsupervised learning based on Self-Organizing Maps (SOM);
Faigl, J.: *Self-organizing map for orienteering problem with dubins vehicle*, Advances in Self-Organizing Maps, Learning Vector Quantization, Clustering and Data Visualization, 2017, pp. 125–132.

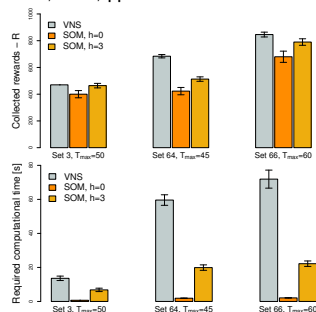
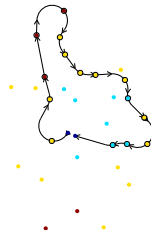
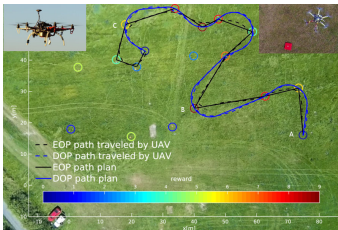

The VNS-based approach provides better solutions than the SOM-based solution, but it tends to be more demanding.



Outline

- Dubins Vehicle and Dubins Planning
- Dubins Touring Problem (DTP)
- Dubins Traveling Salesman Problem
- Dubins Traveling Salesman Problem with Neighborhoods
- Dubins Orienteering Problem
- **Dubins Orienteering Problem with Neighborhoods**
- Planning in 3D – Examples and Motivations



Variable Neighborhoods Search (VNS) for the DOPN

Algorithm 3: VNS based method for the DOPN

```

Input :  $S$  – Set of the target locations
Input :  $T_{\max}$  – Maximal allowed budget
Input :  $o$  – Initial number of position waypoints for each target
Input :  $m$  – Initial number of heading values for each waypoints
Input :  $r_i$  – Local waypoint improvement ratio
Input :  $l_{\max}$  – Maximal neighborhood number
Output:  $P$  – Found data collecting path
 $S_r \leftarrow \text{getReachableLocations}(S, T_{\max})$ 
 $P \leftarrow \text{createInitialPath}(S_r, T_{\max})$  // greedy
while Stopping condition is not met do
   $l \leftarrow 1$ 
  while  $l \leq l_{\max}$  do
     $P' \leftarrow \text{shake}(P, l)$ 
     $P'' \leftarrow \text{localSearch}(P', l, r_i)$ 
    if  $\mathcal{L}_d(P'') \leq T_{\max}$  and
       $[[R(P'') > R(P)] \text{ or } [R(P'') == (P) \text{ and}$ 
         $\mathcal{L}_d(P'') < \mathcal{L}_d(P)\mathcal{L}_d(P'')]]$  then
       $P \leftarrow P''$ 
       $l \leftarrow 1$ 
    else
       $l \leftarrow l + 1$ 
    end
  end
end

```

The particular l for the individual operators of the **shake** procedure are:

- **Waypoint Shake** ($l = 1$);
- **Path Move** ($l = 2$);
- **Path Exchange** ($l = 3$).

The **local search** procedure consists of three operators and the particular l for the individual operators of the **local search** procedure are:

- **Waypoint Improvement** ($l = 1$);
- **One Point Move** ($l = 2$);
- **One Point Exchange** ($l = 3$).

Pěnička, R., Faigl, J., Saska, M., and Váňa, P.: *Data collection planning with non-zero sensing distance for a budget and curvature constrained unmanned aerial vehicle*, *Autonomous Robots*, 43(8):1937–1956, 2019.



VNS for DOPN – Example of the Shake Operators

Path Move

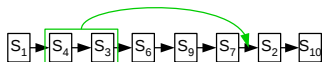
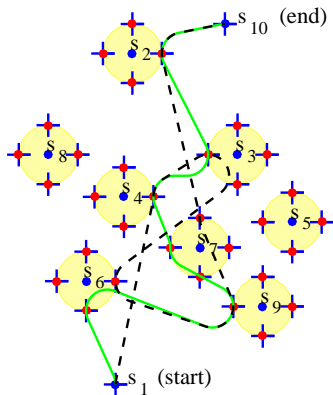

Path Exchange

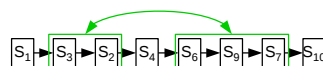
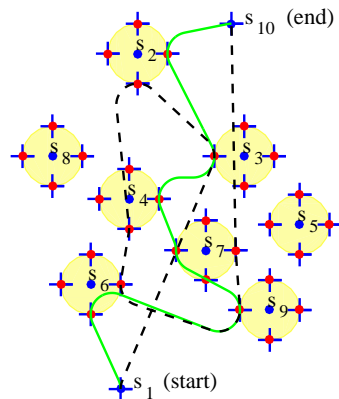

DOPN – Example of Solution and Practical Deployment

- VNS-based solution of the DOPN.

Pěnička, R., Faigl, J., Váňa, P., and Saska, M.: *Dubins Orienteering Problem with Neighborhoods*, International Conference on Unmanned Aircraft Systems (ICUAS), 2017, pp. 1555–1562.

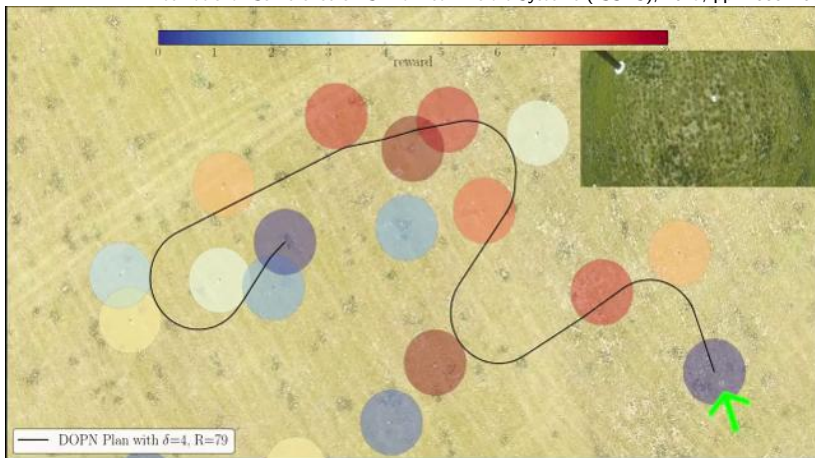

<http://mrs.felk.cvut.cz/jint17dopn>



Outline

- Dubins Vehicle and Dubins Planning
- Dubins Touring Problem (DTP)
- Dubins Traveling Salesman Problem
- Dubins Traveling Salesman Problem with Neighborhoods
- Dubins Orienteering Problem
- Dubins Orienteering Problem with Neighborhoods
- Planning in 3D – Examples and Motivations



3D Data Collection Planning with Dubins Airplane Model

- **Dubins Airplane model** describes the vehicle state

$q = (p, \theta, \psi)$, $p \in \mathbb{R}^3$ and $\theta, \psi \in \mathbb{S}^1$ as

$$\begin{bmatrix} \dot{x} \\ \dot{y} \\ \dot{z} \\ \dot{\theta} \end{bmatrix} = v \begin{bmatrix} \cos \theta \cdot \cos \psi \\ \sin \theta \cdot \cos \psi \\ \sin \psi \\ u_\theta \cdot \rho^{-1} \end{bmatrix}.$$

H. Chitsaz and S. M. LaValle: *Time-optimal paths for a Dubins airplane*, IEEE Conference on Decision and Control, 2007, pp. 2379–2384.

- Constant forward velocity v , the minimal turning radius ρ , and limited pitch angle, i.e., $\psi \in [\psi_{min}, \psi_{max}]$.
- u_θ controls the vehicle heading, $|u_\theta| \leq 1$, and v is the forward velocity.
- Generation of the 3D trajectory is based on the 2D Dubins maneuver.
- If altitude changes are too high, additional helix segments are inserted.

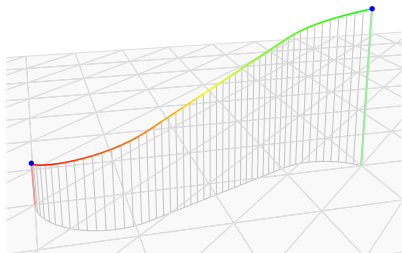
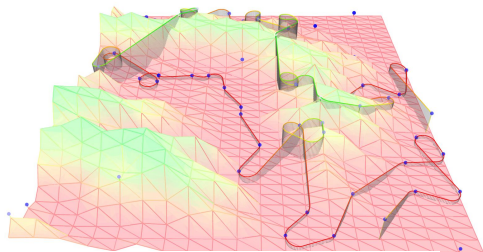

The DTSPN in 3D

- Using the same principles as for the DTSPN in 2D, we can generalize the approaches for 3D planning using the Dubins Airplane model instead of simple Dubins vehicle.
- The regions can be generalized to 3D and the problem can be addressed by decoupled or sampling-based approaches, i.e., using GATSP formulation.
- In the case of LIO, we need a parametrization of the possible waypoint location, such as point on the object boundary.

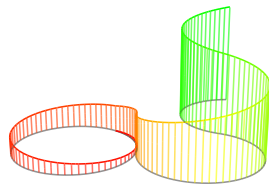

CCC maneuver

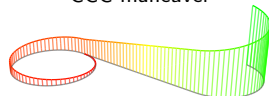

CSC maneuver

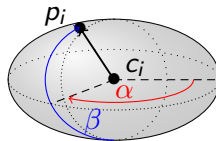
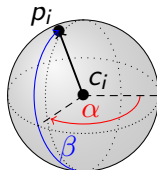
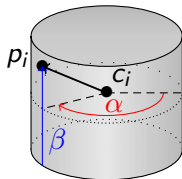

Solutions of the 3D-DTSPN

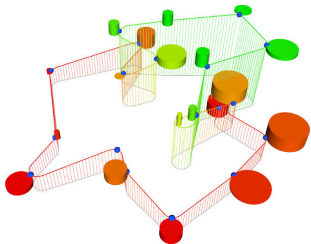

Algorithm 4: LIO-based Solver for 3D-DTSPN

Data: Regions \mathcal{R}

Result: Solution represented by Q and Σ

$\Sigma \leftarrow \text{getInitialSequence}(\mathcal{R});$

$Q \leftarrow \text{getInitialSolution}(\mathcal{R}, \Sigma);$

while *terminal condition* **do**

$Q \leftarrow \text{optimizeHeadings}(Q, \mathcal{R}, \Sigma);$

$Q \leftarrow \text{optimizeAlpha}(Q, \mathcal{R}, \Sigma);$

$Q \leftarrow \text{optimizeBeta}(Q, \mathcal{R}, \Sigma);$

end

return $Q, \Sigma;$

- Solutions based on LIO (ETSP+LIO), TSP with the travel cost according to Dubins Airplane Model (DAM-TSP+LIO), and sampling-based approach with transformation of the GTSP to the ATSP solved by LKH.

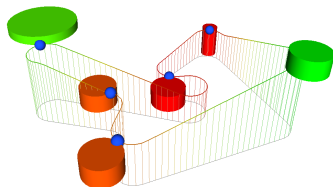
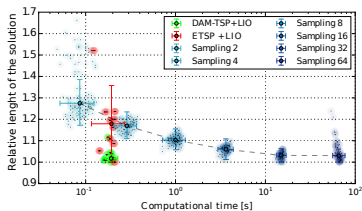

Váňa, P., Faigl, J., Sláma, J., and Pěnička, R.: *Data collection planning with Dubins airplane model and limited travel budget* European Conference on Mobile Robots (ECMR), 2017.



3D Surveillance Planning

- Parametrization of smooth 3D multi-goal trajectory as a sequence of Bézier curves.
- Unsupervised learning for the TSPN can be generalized for such trajectories.
- During the solution of the sequencing part of the problem, we can determine a velocity profile along the curve and compute the so-called *Travel Time Estimation* (TTE).
- Bézier curves better fit the limits of the multi-rotor UAVs that are limited by the maximal accelerations and velocities rather than minimal turning radius as for Dubins vehicle.

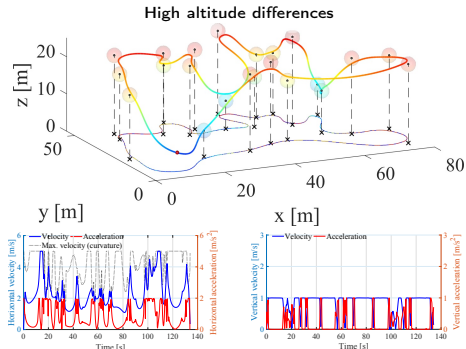
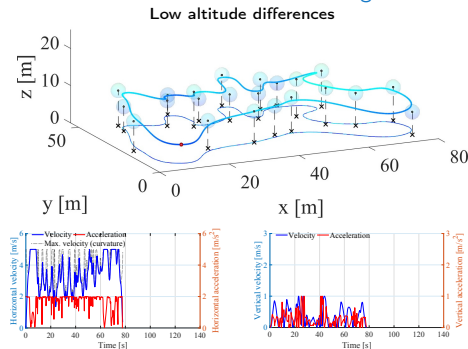

Faigl, J. and Váňa, P.: *Surveillance Planning With Bézier Curves*, IEEE Robotics and Automation Letters, 3(2):750–757, 2018.

- Low altitude differences saturate horizontal velocity while high altitudes changes saturate vertical velocity.



Multi-Vehicle Multi-Goal Planning with Limited Travel Budget –

Curvature-Constrained Team Orienteering Problem (with Neighborhoods)

- Operational time of multi-rotor aerial vehicles is limited and only a subset of locations can be visited.
- Planning multi-goal trajectories as a sequence of Bézier curves.

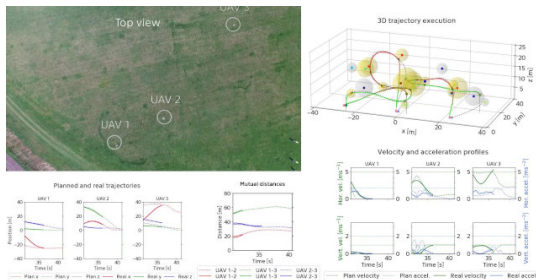
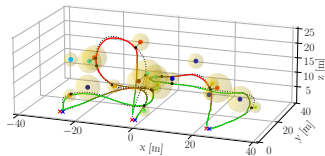

Orienteering Problem with Bézier curves: Non-crossing field experiment with 3 multi-rotor drones

- Targets are missed in a case of colliding trajectories, because of local collision avoidance and optimal trajectory following.
- There is a practical need to include coordination in multi-vehicle multi-goal trajectory planning.

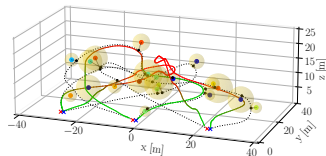

Faigl, J., Váňa, P., and Pěnička, R.: *Multi-Vehicle Close Enough Orienteering Problem with Bézier Curves for Multi-Rotor Aerial Vehicles*. ICRA 2019, pp. 3039–3044.



Summary of the Lecture



Summary

- Data collection planning with curvature-constrained paths/trajectories
 - The **Traveling Salesman Problem (TSP)** and **Orienteering Problem (OP)** with Dubins Vehicle, i.e., **DTSP** and **DOP**.
 - It is a combination of the combinatorial and continuous (determining optimal headings) optimization.
 - The continuous part can be solved using **Dubins Touring Problem (DTP)**.
 - Using a solution of the **Dubins Interval Problem (DIP)** we can establish **tight lower bound** of the DTP and DTSP with a particular sequence of visits.
 - The problems can be further extended to **DTSP with Neighborhoods (DTSPN)** and **OP with Neighborhoods (DOPN)**, and its **Close Enough** variants.
- The key ideas of the presented problems and approaches are as follows.
 - Consider proper assumptions that fits the original problem being solved.
 - Suitability of the vehicle model, requirements on the solution quality, and benefit of optimal or computationally demanding solutions.
 - Employing lower bound based on “a bit different problem” such as the **DIP** and **GDIP**, to find high quality solutions, even using decoupled approaches.
 - Challenging problems with continuous optimization can be addressed by decoupled and sampling-based approaches.
 - Be aware that the optimal solutions found for discretized problems, e.g., using ILP or combinatorial solvers, are not optimal solutions of the original (continuous) problem!



Topics Discussed

- Dubins vehicles and planning – Dubins maneuvers
- **Dubins Interval Problem (DIP)** (Lower bound estimation to the DTP, DTSP)
- **Dubins Touring Problem (DTP)**
- Dubins Traveling Salesman Problem (DTSP) and Dubins Traveling Salesman with Neighborhoods (DTSPN)
 - Decoupled approaches – Alternating Algorithm
 - Sampling-based approaches – GATSP
- **Generalized Dubins Interval Problem (GDIP)** (Lower bound estimation to the DTSPN)
- Dubins Orienteering Problem (OP) and Dubins Orienteering Problem with Neighborhoods (DOPN)
- Data collection and surveillance planning in 3D

- **Next: Sampling-based motion planning**

