

Magnetic resonance imaging

Part 2

J. Kybic, J. Hornak¹, M. Bock, J. Hozman, P. Döubek

Department of cybernetics, FEE CTU
<http://cmp.felk.cvut.cz/~kybic>
kybic@fel.cvut.cz

2008–2022

¹<http://www.cis.rit.edu/htbooks/mri/>

Excitation sequences

Free induction decay

Spin echo

Positional encoding

Frequency encoding

Slice selection

Phase encoding

Mathematics of Fourier encoding

Quadrature detector

Aliasing

Reconstruction

MRI excitation sequence

Time sequence

- radio frequency pulses
- magnetic field changes
- signal acquisition intervals

for signal or image acquisition

90° Free induction decay (FID)

- 90° pulse flips **M** to *xy* plane

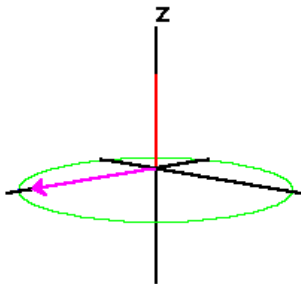

90° Free induction decay (FID)

- 90° pulse flips **M** to xy plane

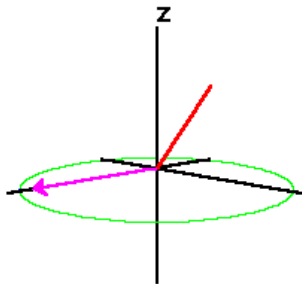

90° Free induction decay (FID)

- 90° pulse flips **M** to *xy* plane

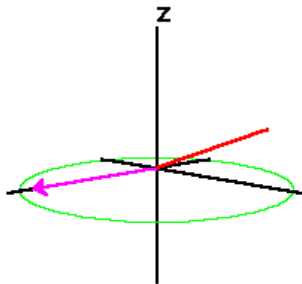

90° Free induction decay (FID)

- 90° pulse flips **M** to *xy* plane

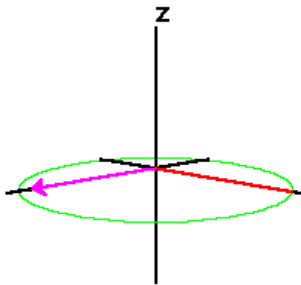

90° Free induction decay (FID)

- 90° pulse flips **M** to xy plane
- Magnetization **M** starts to rotate around z (precession)

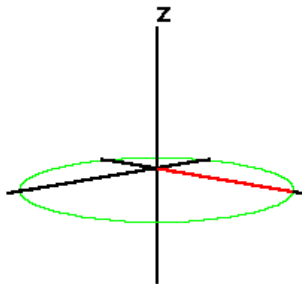

90° Free induction decay (FID)

- 90° pulse flips **M** to xy plane
- Magnetization **M** starts to rotate around z (precession)

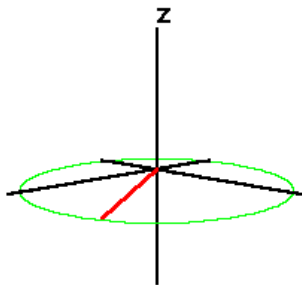

90° Free induction decay (FID)

- 90° pulse flips **M** to xy plane
- Magnetization **M** starts to rotate around z (precession)

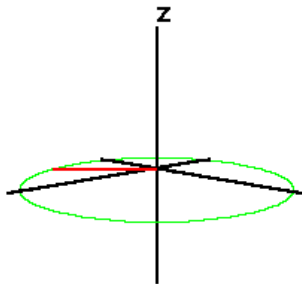

90° Free induction decay (FID)

- 90° pulse flips **M** to xy plane
- Magnetization **M** starts to rotate around z (precession)

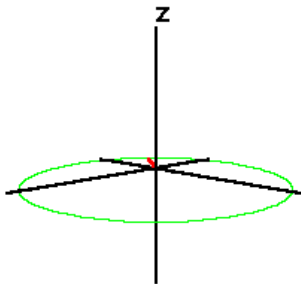

90° Free induction decay (FID)

- 90° pulse flips **M** to xy plane
- Magnetization **M** starts to rotate around z (precession)

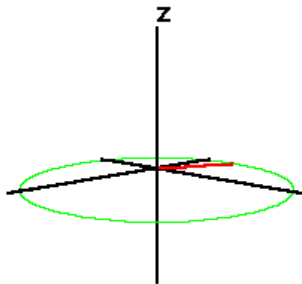

90° Free induction decay (FID)

- 90° pulse flips \mathbf{M} to xy plane
- Magnetization \mathbf{M} starts to rotate around z (precession)

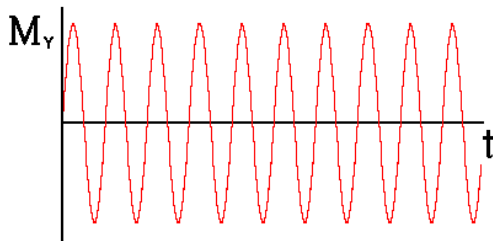

90° Free induction decay (FID)

- 90° pulse flips \mathbf{M} to xy plane
- Magnetization \mathbf{M} starts to rotate around z (precession)
- Exponential decay of $\|\mathbf{M}\|$ (FID) because of T_2 relaxation

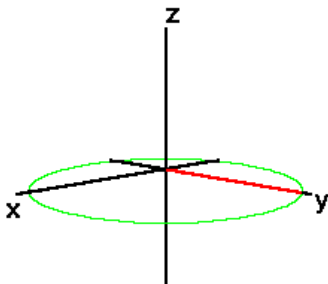

90° Free induction decay (FID)

- 90° pulse flips \mathbf{M} to xy plane
- Magnetization \mathbf{M} starts to rotate around z (precession)
- Exponential decay of $\|\mathbf{M}\|$ (FID) because of T_2 relaxation

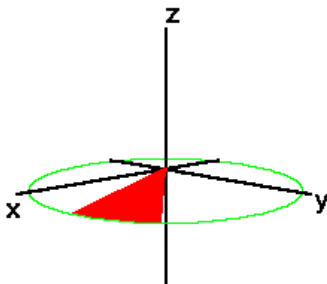

90° Free induction decay (FID)

- 90° pulse flips \mathbf{M} to xy plane
- Magnetization \mathbf{M} starts to rotate around z (precession)
- Exponential decay of $\|\mathbf{M}\|$ (FID) because of T_2 relaxation

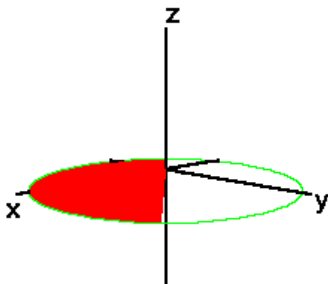

90° Free induction decay (FID)

- 90° pulse flips \mathbf{M} to xy plane
- Magnetization \mathbf{M} starts to rotate around z (precession)
- Exponential decay of $\|\mathbf{M}\|$ (FID) because of T_2 relaxation

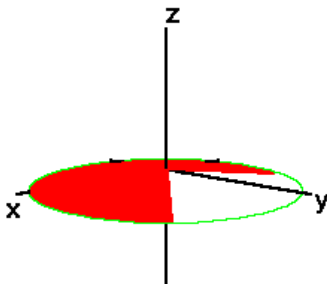

90° Free induction decay (FID)

- 90° pulse flips \mathbf{M} to xy plane
- Magnetization \mathbf{M} starts to rotate around z (precession)
- Exponential decay of $\|\mathbf{M}\|$ (FID) because of T_2 relaxation

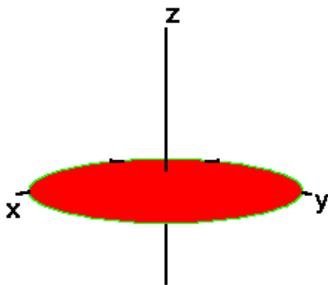

90° Free induction decay (FID)

- 90° pulse flips \mathbf{M} to xy plane
- Magnetization \mathbf{M} starts to rotate around z (precession)
- Exponential decay of $\|\mathbf{M}\|$ (FID) because of T_2 relaxation

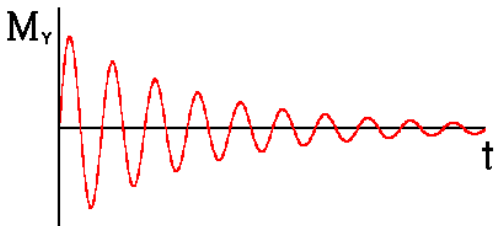

90° Free induction decay (FID)

- 90° pulse flips \mathbf{M} to xy plane
- Magnetization \mathbf{M} starts to rotate around z (precession)
- Exponential decay of $\|\mathbf{M}\|$ (FID) because of T_2 relaxation
- Time diagram / Excitation sequence

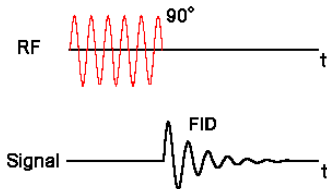

90° Free induction decay (FID)

- 90° pulse flips \mathbf{M} to xy plane
- Magnetization \mathbf{M} starts to rotate around z (precession)
- Exponential decay of $\|\mathbf{M}\|$ (FID) because of T_2 relaxation
- Time diagram / Excitation sequence

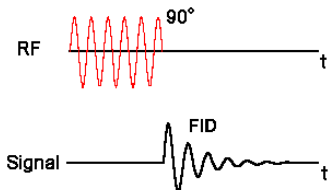

Sequence is repeated with period T_R (repetition time).

Complete and partial relaxation

- For maximum signal wait until complete T_1 relaxation ($T_R > T_1 \approx 1$ s) — long acquisition
- Shorter $T_R \rightarrow$ only partial relaxation, smaller $M_z \rightarrow$ smaller M_{xy}

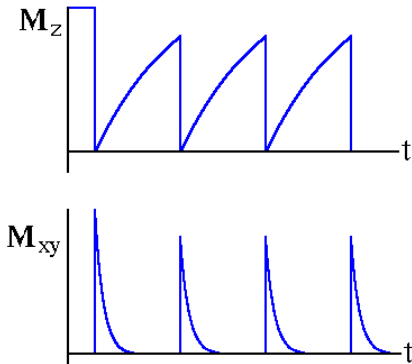

Complete and partial relaxation

- For maximum signal wait until complete T_1 relaxation ($T_R > T_1 \approx 1$ s) — long acquisition
- Shorter $T_R \rightarrow$ only partial relaxation, smaller $M_z \rightarrow$ smaller M_{xy}
- Calibration cycles before each slice acquisition.

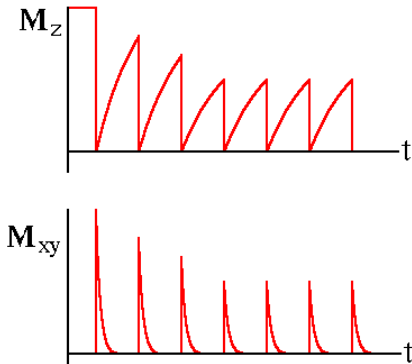

90° Free induction decay (2)

Signal intensity after excitation

$$S \propto \rho \left(1 - e^{-\frac{T_R}{T_1}}\right)$$

depends on M_z , which depends on T_R — time from the previous excitation.

S — signal amplitude

ρ — spin density

T_R — repetition time ($T_R > T_2$)

Spin-echo sequence

- 90° pulse

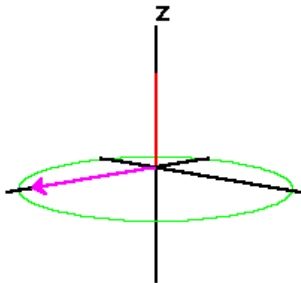

Erwin Hahn, 1949

Spin-echo sequence

- 90° pulse

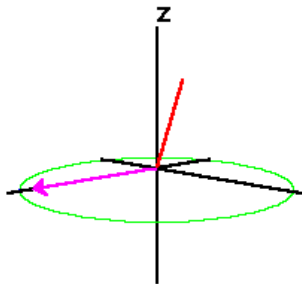

Erwin Hahn, 1949

Spin-echo sequence

- 90° pulse

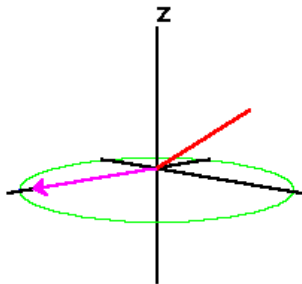

Erwin Hahn, 1949

Spin-echo sequence

- 90° pulse

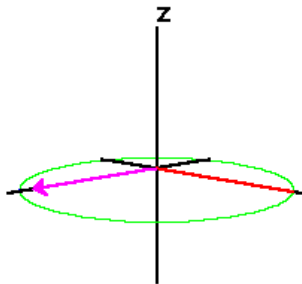

Erwin Hahn, 1949

Spin-echo sequence

- 90° pulse
- Spins start to desynchronize

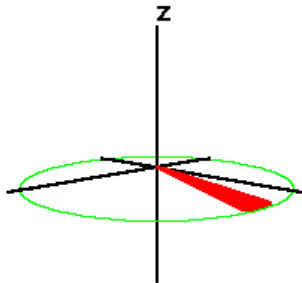

Erwin Hahn, 1949

Spin-echo sequence

- 90° pulse
- Spins start to desynchronize

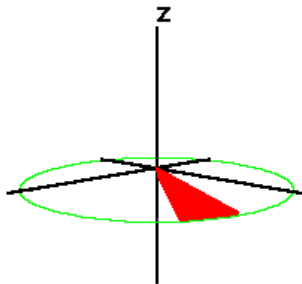

Erwin Hahn, 1949

Spin-echo sequence

- 90° pulse
- Spins start to desynchronize

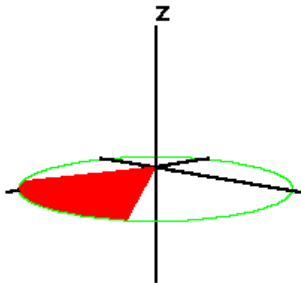

Erwin Hahn, 1949

Spin-echo sequence

- 90° pulse
- Spins start to desynchronize

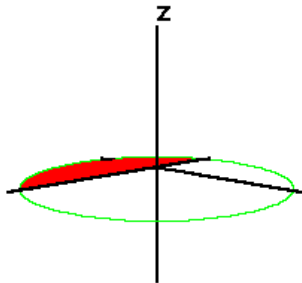

Erwin Hahn, 1949

Spin-echo sequence (2)

- 180° pulse — rotation around x'

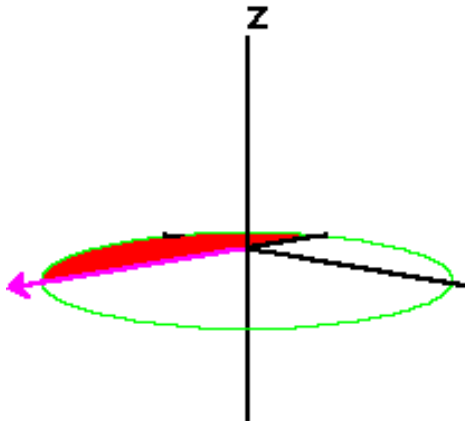

Spin-echo sequence (2)

- 180° pulse — rotation around x'

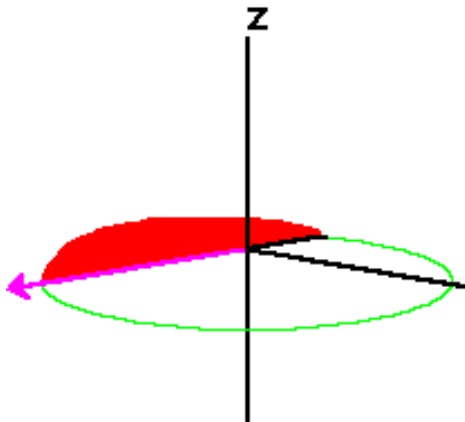

Spin-echo sequence (2)

- 180° pulse — rotation around x'

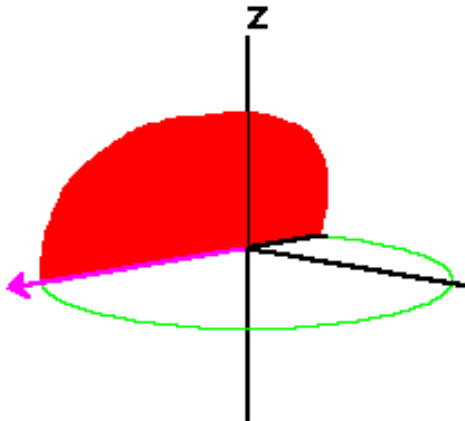

Spin-echo sequence (2)

- 180° pulse — rotation around x'

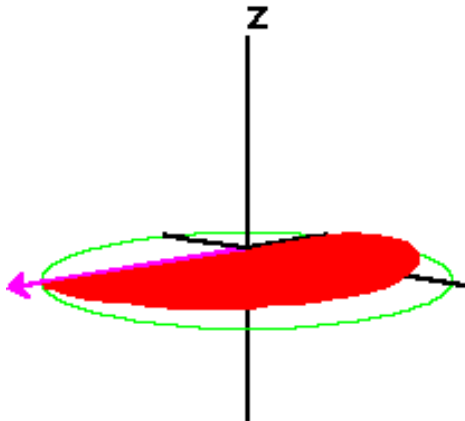

Spin-echo sequence (2)

- 180° pulse — rotation around x'
- Resynchronization (slower spins will be ahead and vice versa)

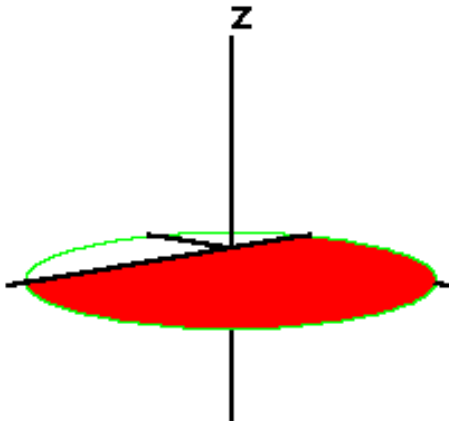

Spin-echo sequence (2)

- 180° pulse — rotation around x'
- Resynchronization (slower spins will be ahead and vice versa)

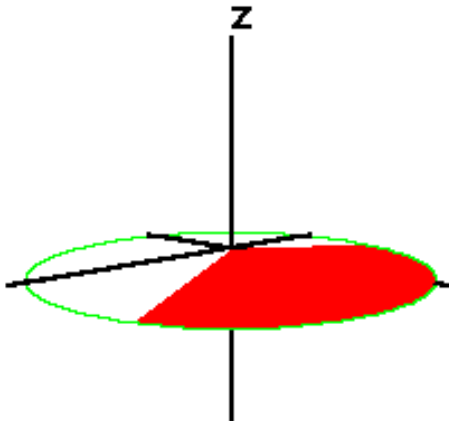

Spin-echo sequence (2)

- 180° pulse — rotation around x'
- Resynchronization (slower spins will be ahead and vice versa)

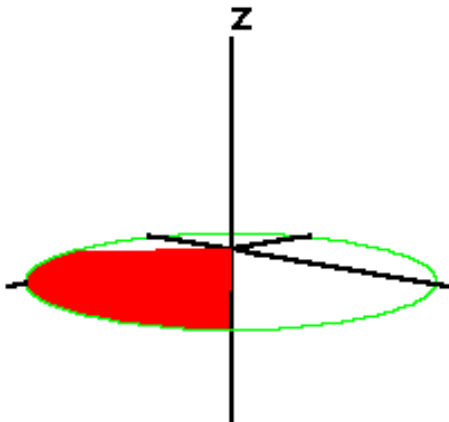

Spin-echo sequence (2)

- 180° pulse — rotation around x'
- Resynchronization (slower spins will be ahead and vice versa)
- Echo signal appears

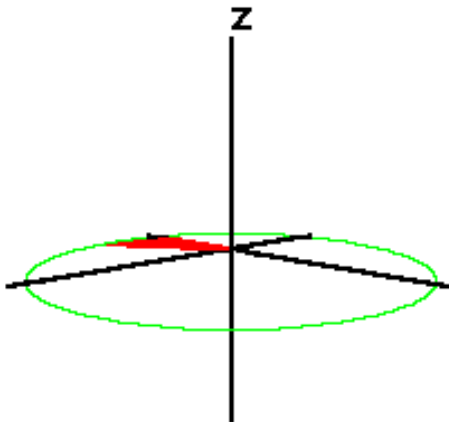

Spin-echo sequence (2)

- 180° pulse — rotation around x'
- Resynchronization (slower spins will be ahead and vice versa)
- Echo signal appears

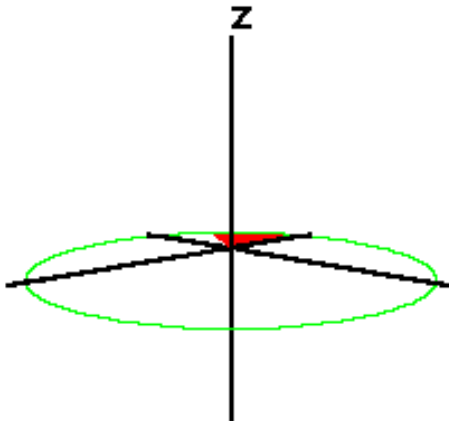

Spin-echo sequence (2)

- 180° pulse — rotation around x'
- Resynchronization (slower spins will be ahead and vice versa)
- Echo signal appears

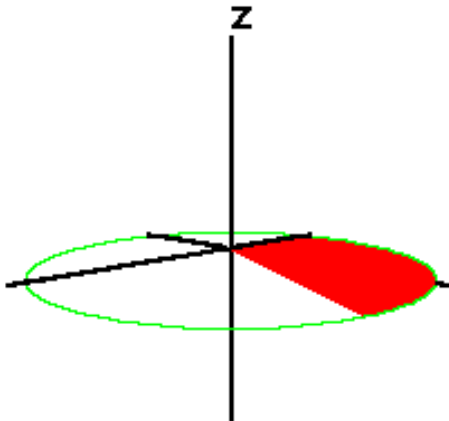

Spin-echo sequence (2)

- 180° pulse — rotation around x'
- Resynchronization (slower spins will be ahead and vice versa)
- Echo signal appears

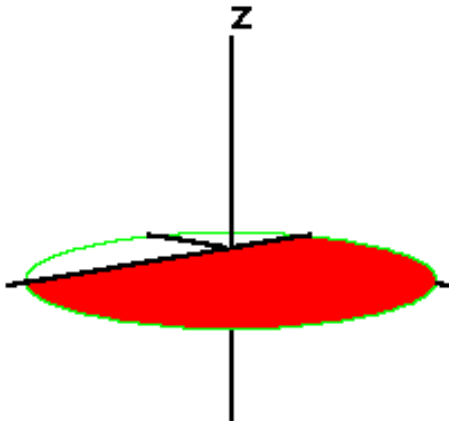

Spin-echo sequence (2)

- 180° pulse — rotation around x'
- Resynchronization (slower spins will be ahead and vice versa)
- Echo signal appears
- Time diagram

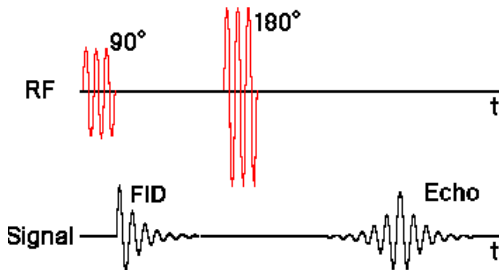

Spin-echo sequence (3)

Signal intensity

$$S \propto \rho \left(1 - e^{-\frac{T_R}{T_1}}\right) e^{-\frac{T_E}{T_2}}$$

S — signal amplitude

ρ — spin density

T_R — repetition time

T_E — echo time (time between the 90° pulse and readout)

T_1 — spin-lattice relaxation time

T_2 — spin-spin relaxation time

changing T_R a T_E determines the influence of T_1 and T_2

Spin-echo sequence — T_2^{inhom} compensation

T_2^* relaxation is caused by spin-spin interactions (T_2) and field inhomogeneity (T_2^{inhom})

$$\frac{1}{T_2^*} = \frac{1}{T_2} + \frac{1}{T_2^{\text{inhom}}}$$

resynchronization compensates the inhomogeneity (T_2^{inhom}) to measure T_2

- homogeneous samples: $T_2^{\text{inhom}} \gg T_2 \rightarrow T_2^* \approx T_2$
- real tissues: $T_2^{\text{inhom}} < T_2 \rightarrow T_2^* < T_2$

Inversion recovery sequence

- 180° pulse \rightarrow magnetization $\mathbf{M} \rightarrow -z$

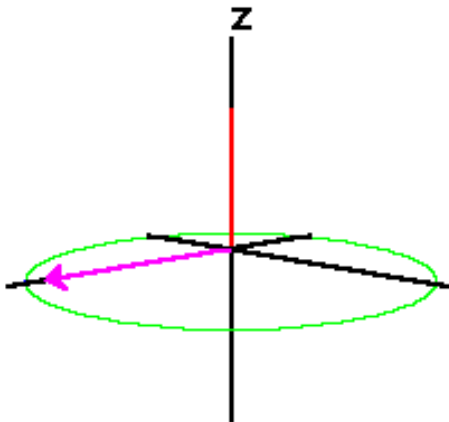

Inversion recovery sequence

- 180° pulse \rightarrow magnetization $\mathbf{M} \rightarrow -z$

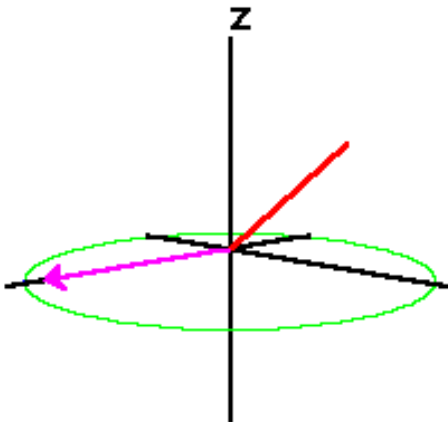

Inversion recovery sequence

- 180° pulse \rightarrow magnetization $\mathbf{M} \rightarrow -z$

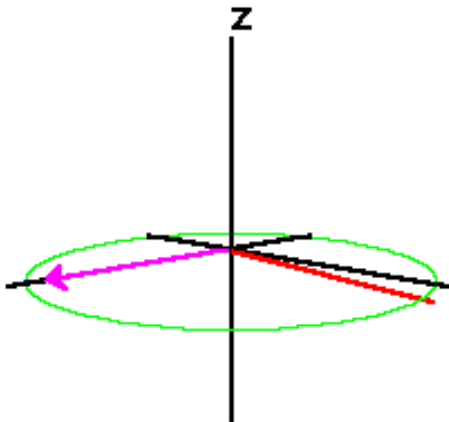

Inversion recovery sequence

- 180° pulse \rightarrow magnetization $\mathbf{M} \rightarrow -z$

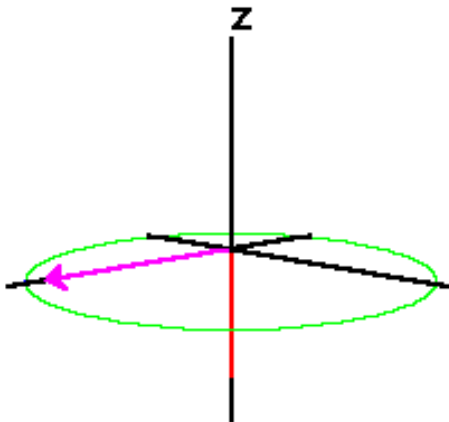

Inversion recovery sequence

- 180° pulse \rightarrow magnetization $\mathbf{M} \rightarrow -z$
- Before equilibrium, 90° pulse \rightarrow precession around z

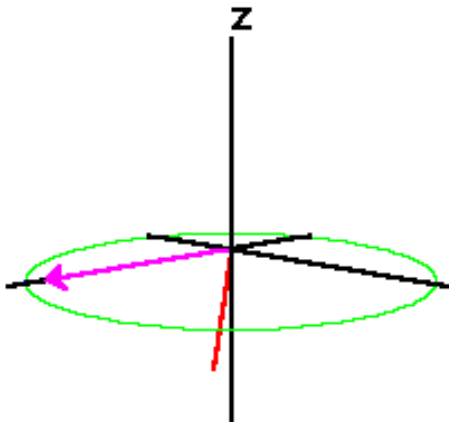

Inversion recovery sequence

- 180° pulse \rightarrow magnetization $\mathbf{M} \rightarrow -z$
- Before equilibrium, 90° pulse \rightarrow precession around z

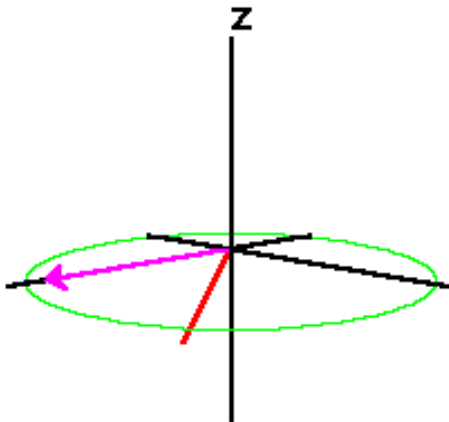

Inversion recovery sequence

- 180° pulse \rightarrow magnetization $\mathbf{M} \rightarrow -z$
- Before equilibrium, 90° pulse \rightarrow precession around z

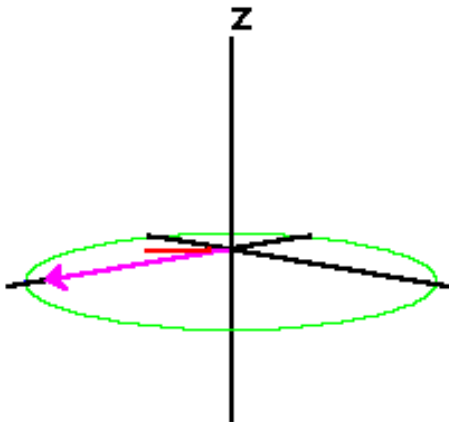

Inversion recovery sequence

- 180° pulse \rightarrow magnetization $\mathbf{M} \rightarrow -z$
- Before equilibrium, 90° pulse \rightarrow precession around z

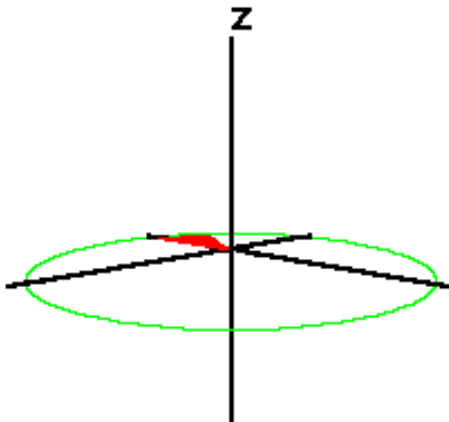

Inversion recovery sequence

- 180° pulse \rightarrow magnetization $\mathbf{M} \rightarrow -z$
- Before equilibrium, 90° pulse \rightarrow precession around z

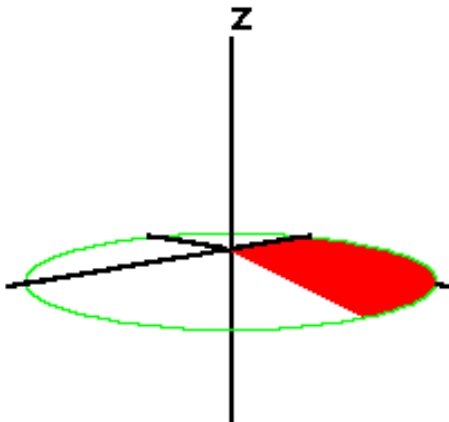

Inversion recovery sequence

- 180° pulse \rightarrow magnetization $\mathbf{M} \rightarrow -z$
- Before equilibrium, 90° pulse \rightarrow precession around z

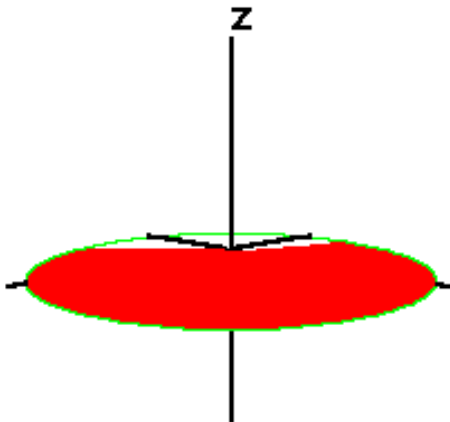

Inversion recovery sequence

- 180° pulse \rightarrow magnetization $\mathbf{M} \rightarrow -z$
- Before equilibrium, 90° pulse \rightarrow precession around z
- Time diagram

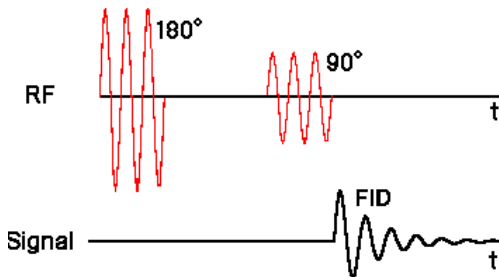

Inversion recovery (2)

- Good choice of T_I suppresses tissue with specific T_1
- RF impuls when $M_z = 0 \rightarrow$ no signal

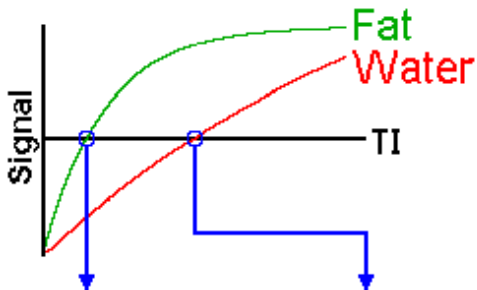

Inversion recovery sequence (2)

Signal amplitude after the 90° pulse after one repetition

$$S \propto \rho \left(1 - 2e^{-\frac{T_I}{T_1}} \right)$$

Signal amplitude after many repetitions

$$S \propto \rho \left(1 - 2e^{-\frac{T_I}{T_1}} + e^{-\frac{T_R}{T_1}} \right)$$

S — signal amplitude

ρ — spin density

T_R — repetition time

T_E — echo time (between the 90° pulse and readout)

T_1 — spin-lattice relaxation time

T_I — inversion time (between the 90° and 180° pulses)

Excitation sequences

Free induction decay

Spin echo

Positional encoding

Frequency encoding

Slice selection

Phase encoding

Mathematics of Fourier encoding

Quadrature detector

Aliasing

Reconstruction

Magnetic field gradient

$$f = \gamma B$$

- spatially dependent B
- \rightarrow spatially dependent f

$$B_z = B_0 + xG_x + yG_y + zG_z$$

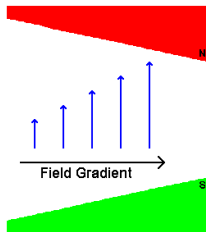

Magnet isocenter

In the origin $(0,0,0)$, field $B_z = B_0$

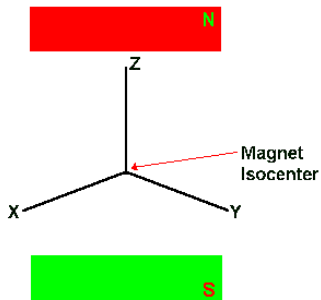

Frequency encoding

Magnetic field: $B_z = B_0 + xG_x$

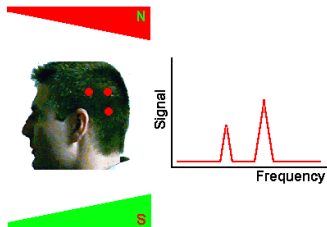

Frequency: $f = \gamma(B_0 + xG_x)$

Excitation sequences

Free induction decay

Spin echo

Positional encoding

Frequency encoding

Slice selection

Phase encoding

Mathematics of Fourier encoding

Quadrature detector

Aliasing

Reconstruction

Slice selection

- Gradient G_z together with RF pulse with frequency f
- Only spins at the resonance frequency are excited

$$\gamma(B_0 + zG_z) = f$$

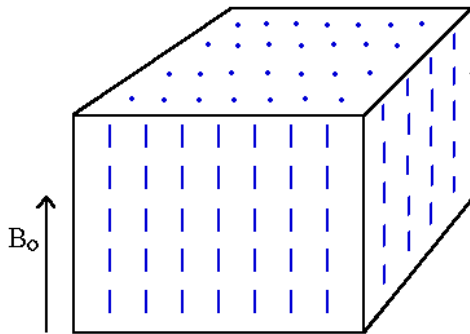

Slice selection

- Gradient G_z together with RF pulse with frequency f
- Only spins at the resonance frequency are excited

$$\gamma(B_0 + zG_z) = f$$

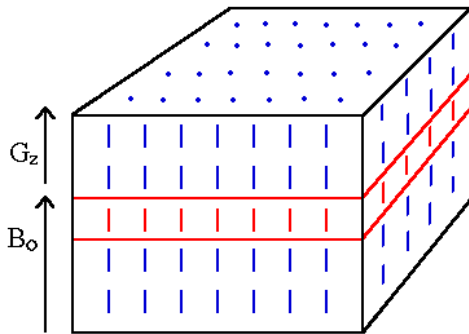

RF pulse envelope shape

- Rectangular 90° pulse $\text{rect}(t) \sin(2\pi ft)$
- ... sinc in the frequency domain ($\text{sinc}(x) = \sin(x)/x$)

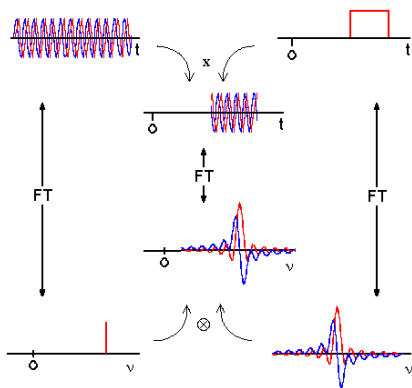

RF pulse envelope shape

- Rectangular 90° pulse $\text{rect}(t) \sin(2\pi ft)$
- ... sinc in the frequency domain ($\text{sinc}(x) = \sin(x)/x$)
- \rightarrow excitation profile is not rectangular

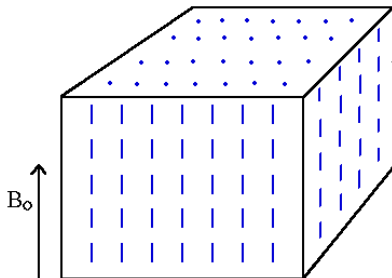

RF pulse envelope shape

- Rectangular 90° pulse $\text{rect}(t) \sin(2\pi ft)$
- ... sinc in the frequency domain ($\text{sinc}(x) = \sin(x)/x$)
- \rightarrow excitation profile is not rectangular

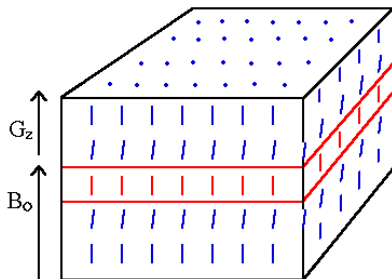

RF pulse envelope shape

- Rectangular 90° pulse $\text{rect}(t) \sin(2\pi ft)$
- ... sinc in the frequency domain ($\text{sinc}(x) = \sin(x)/x$)
- \rightarrow excitation profile is not rectangular

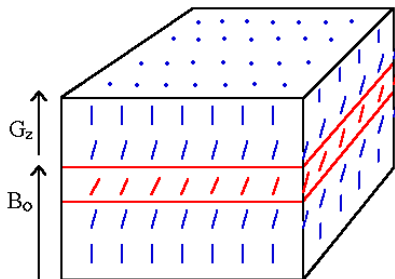

RF pulse envelope shape

- Rectangular 90° pulse $\text{rect}(t) \sin(2\pi ft)$
- ... sinc in the frequency domain ($\text{sinc}(x) = \sin(x)/x$)
- \rightarrow excitation profile is not rectangular

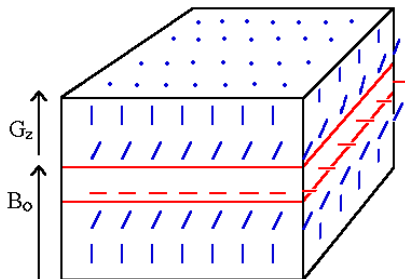

RF pulse envelope shape (2)

- sinc-shaped 90° pulse $\text{sinc} \frac{t-t_0}{\tau} \sin(2\pi ft)$
- ... rectangle in the ve frequency domain

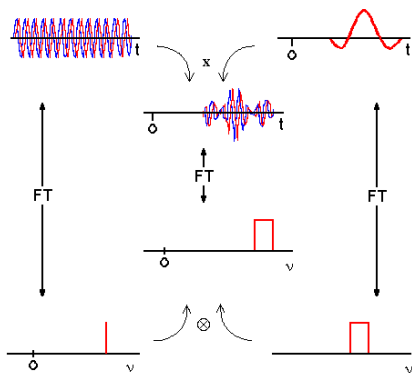

RF pulse envelope shape (2)

- sinc-shaped 90° pulse $\text{sinc} \frac{t-t_0}{\tau} \sin(2\pi ft)$
- ... rectangle in the ve frequency domain
- \rightarrow rectangular excitation profile

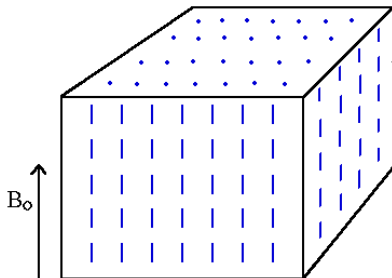

RF pulse envelope shape (2)

- sinc-shaped 90° pulse $\text{sinc} \frac{t-t_0}{\tau} \sin(2\pi ft)$
- ... rectangle in the ve frequency domain
- \rightarrow rectangular excitation profile

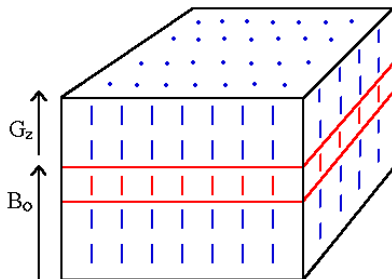

RF pulse envelope shape (2)

- sinc-shaped 90° pulse $\text{sinc} \frac{t-t_0}{\tau} \sin(2\pi ft)$
- ... rectangle in the ve frequency domain
- \rightarrow rectangular excitation profile

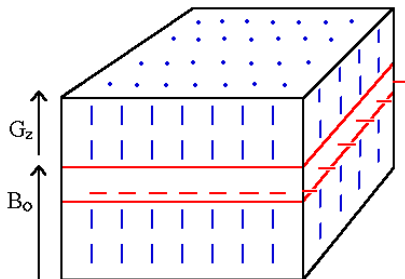

RF pulse envelope shape (3)

- The shorter the RF pulse (in time)
- → the wider in the frequency domain
- → the wider the excited slice
- ... and vice versa

Slice thickness:

$$d = \frac{2\Delta f_{\text{RF}}}{\gamma G_{\text{slice}}}$$

RF pulse envelope shape (3)

- The shorter the RF pulse (in time)
- → the wider in the frequency domain
- → the wider the excited slice
- ... and vice versa

Slice thickness:

$$d = \frac{2\Delta f_{\text{RF}}}{\gamma G_{\text{slice}}}$$

Typical values

- $G_z = 4 \text{ mT/m}$
- bandwidth $\Delta f = 1 \text{ kHz}$
- slice thickness 11.7 mm

Encoding gradients

Gradients of B_z

- Slice selection gradient
- Frequency encoding gradient

Encoding gradients

Gradients of B_z

- Slice selection gradient
- Frequency encoding gradient
- Phase encoding gradient

Phase encoding gradient

- In constant \mathbf{B} , the same f

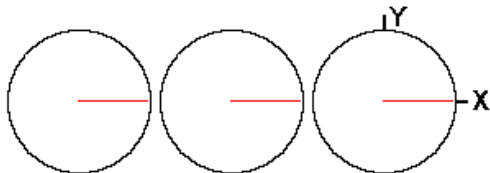

Phase encoding gradient

- In constant \mathbf{B} , the same f

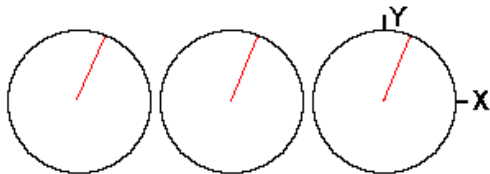

Phase encoding gradient

- In constant \mathbf{B} , the same f

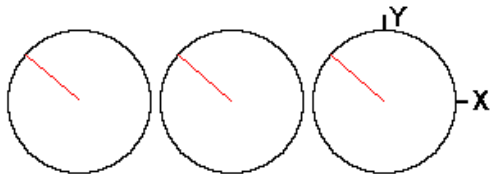

Phase encoding gradient

- In constant \mathbf{B} , the same f
- Gradient G_φ on \rightarrow different f

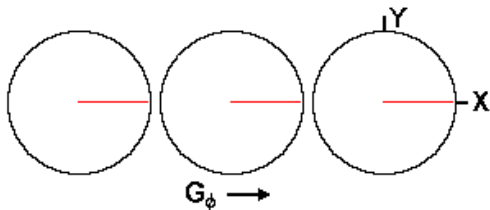

Phase encoding gradient

- In constant \mathbf{B} , the same f
- Gradient G_ϕ on \rightarrow different f

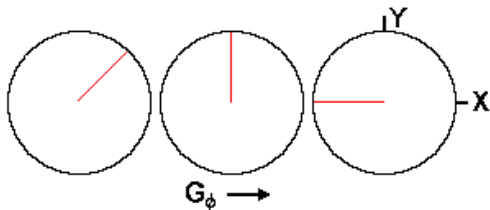

Phase encoding gradient

- In constant \mathbf{B} , the same f
- Gradient G_ϕ on \rightarrow different f

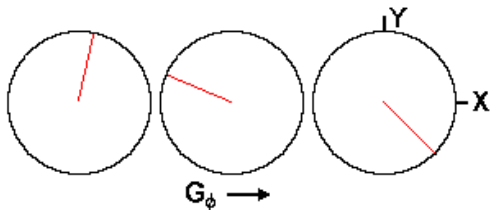

Phase encoding gradient

- In constant \mathbf{B} , the same f
- Gradient G_φ on \rightarrow different f
- Gradient G_φ off \rightarrow same f but different phase

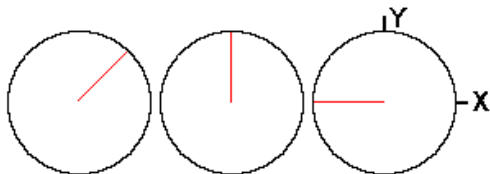

Phase encoding gradient

- In constant \mathbf{B} , the same f
- Gradient G_φ on \rightarrow different f
- Gradient G_φ off \rightarrow same f but different phase

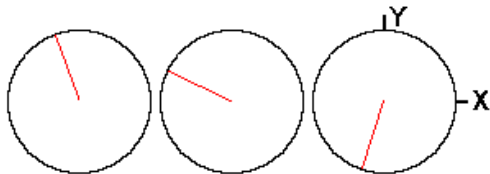

Phase encoding gradient

- In constant \mathbf{B} , the same f
- Gradient G_φ on \rightarrow different f
- Gradient G_φ off \rightarrow same f but different phase

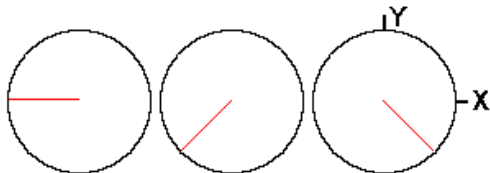

Phase encoding gradient

- In constant \mathbf{B} , the same f
- Gradient G_φ on \rightarrow different f
- Gradient G_φ off \rightarrow same f but different phase
- \rightarrow phase encodes position

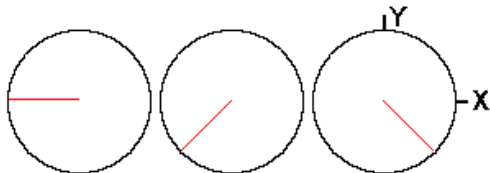

Macroscopic view

- Slice excitation

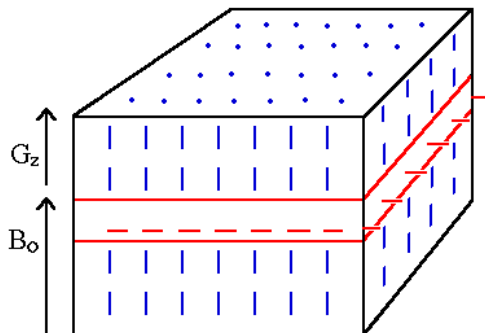

Macroscopic view

- Slice excitation
- After phase and frequency gradient
 - phase is a function of x
 - frequency is a function of y

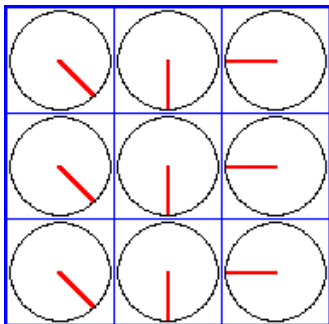

Macroscopic view

- Slice excitation
- After phase and frequency gradient
 - phase is a function of x
 - frequency is a function of y

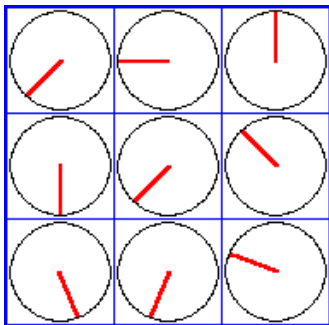

Macroscopic view

- Slice excitation
- After phase and frequency gradient
 - phase is a function of x
 - frequency is a function of y

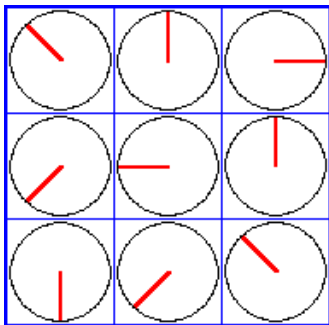

Macroscopic view

- Slice excitation
- After phase and frequency gradient
 - phase is a function of x
 - frequency is a function of y

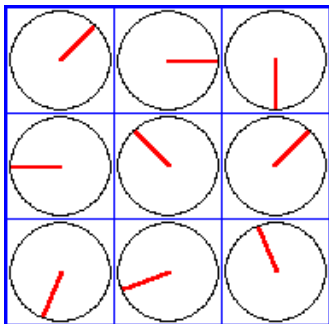

Macroscopic view

- Slice excitation
- After phase and frequency gradient
 - phase is a function of x
 - frequency is a function of y

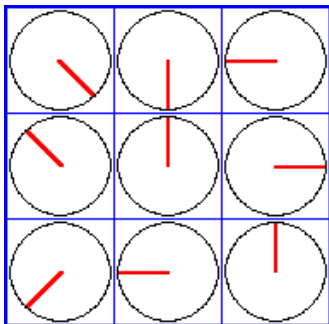

Macroscopic view

- Slice excitation
- After phase and frequency gradient
 - phase is a function of x
 - frequency is a function of y

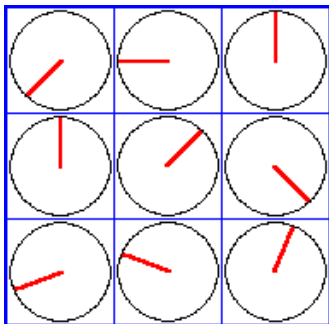

Macroscopic view

- Slice excitation
- After phase and frequency gradient
 - phase is a function of x
 - frequency is a function of y

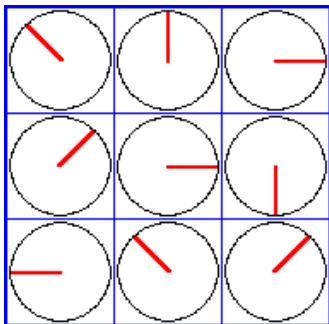

Fourier MRI sequence

- RF pulse

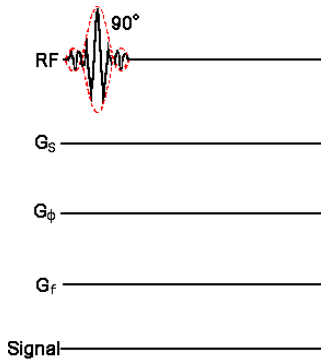

Fourier MRI sequence

- Slice selection gradient

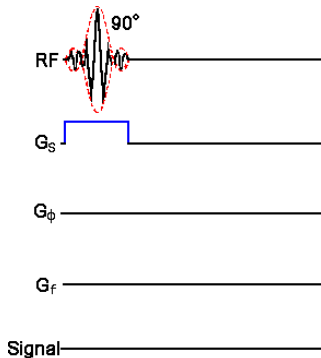

Fourier MRI sequence

- Phase encoding gradient (before readout)

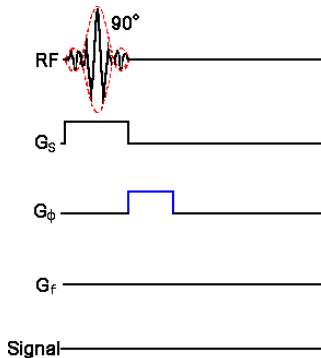

Fourier MRI sequence

- Frequency encoding gradient (during readout)

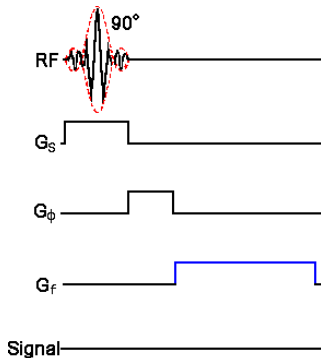

Fourier MRI sequence

- Readout

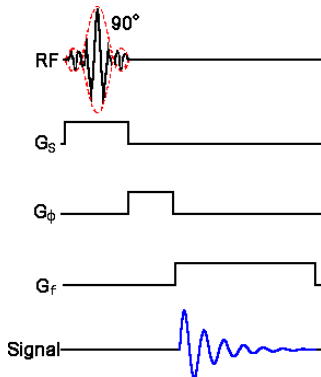

Multiple excitations

- To acquire a 2D slice 128 ~ 512 excitations are needed
- Repetition time T_R
- Phase encoding intensity G_ϕ varies (\pm)

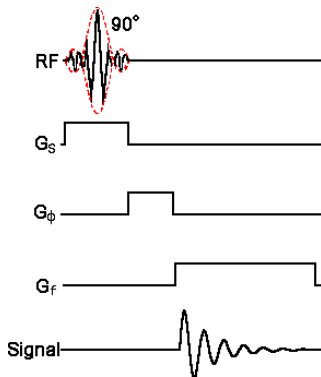

Multiple excitations

- To acquire a 2D slice 128 ~ 512 excitations are needed
- Repetition time T_R
- Phase encoding intensity G_ϕ varies (\pm)

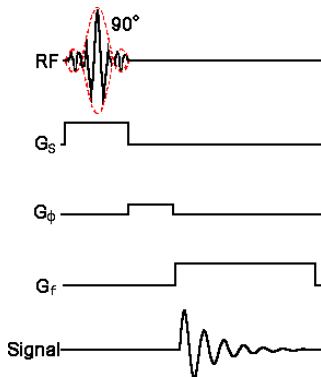

Multiple excitations

- To acquire a 2D slice 128 \sim 512 excitations are needed
- Repetition time T_R
- Phase encoding intensity G_ϕ varies (\pm)

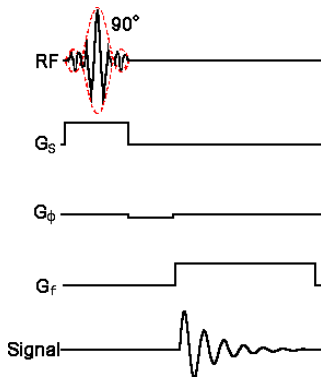

Multiple excitations

- To acquire a 2D slice 128 ~ 512 excitations are needed
- Repetition time T_R
- Phase encoding intensity G_ϕ varies (\pm)

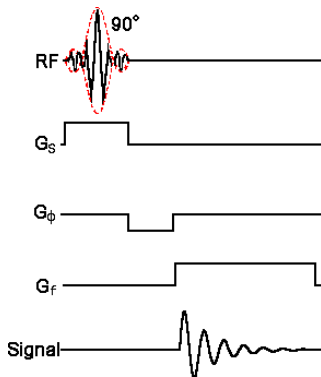

Spin echo — optimized sequence

Time diagram:

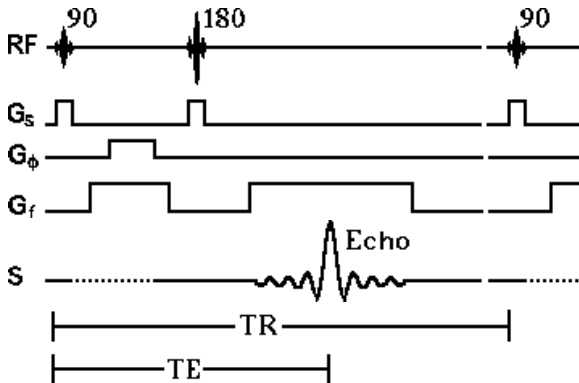

Spin echo — optimized sequence (2)

Note:

- G_ϕ between 90° and 180° pulses \rightarrow shorter T_E
- FID signal not used
- Desynchronization G_f together with $G_\phi \dots$
- $\dots \rightarrow$ maximum synchronization in the center of the readout window
- Sequence repeated for all G_ϕ

Inversion recovery — optimized sequence

Časový diagram:

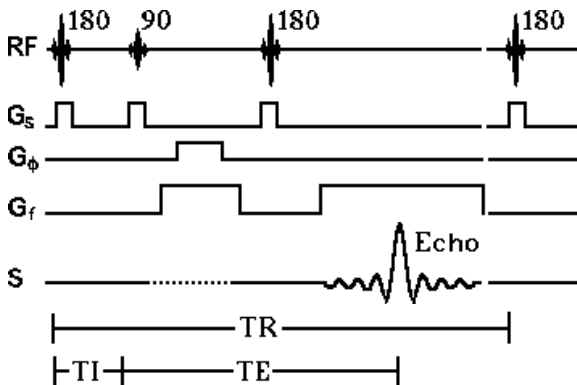

Inversion recovery — optimized sequence (2)

Note:

- All RF pulses are selective (applied together with G_s)
- G_ϕ cannot be after the first 180° pulse (no transversal magnetization) . . .
- . . . applied after the 90° pulse
- starting from the 90° pulse = spin-echo sequence, including desynchronization G_f

Gradient orientation

Gradient along direction φ is a linear combination

$$G_x = G_f \sin \varphi$$

$$G_y = G_f \cos \varphi$$

Slice orientation

- Slice orientation can be arbitrary — xy, yz, xz , or oblique
- All gradients change B_z . Using linear combination

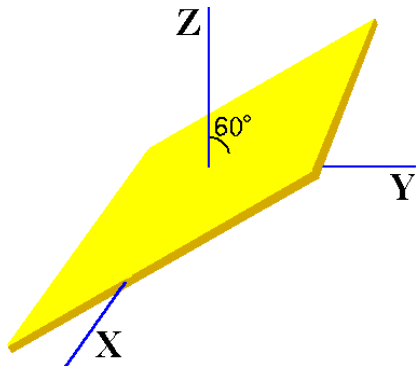

Slice orientation

- Slice orientation can be arbitrary — xy, yz, xz , or oblique
- All gradients change B_z . Using linear combination
- Slice selection gradient perpendicular to the slice plane

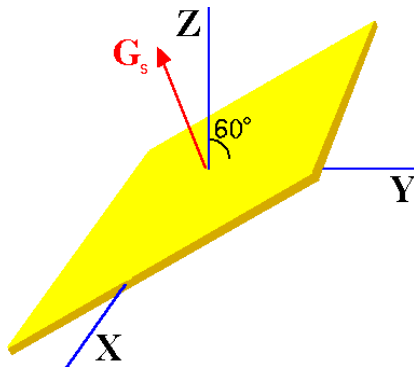

Slice orientation

- Slice orientation can be arbitrary — xy, yz, xz , or oblique
- All gradients change B_z . Using linear combination
- Slice selection gradient perpendicular to the slice plane
- Phase encoding gradient in the slice plane

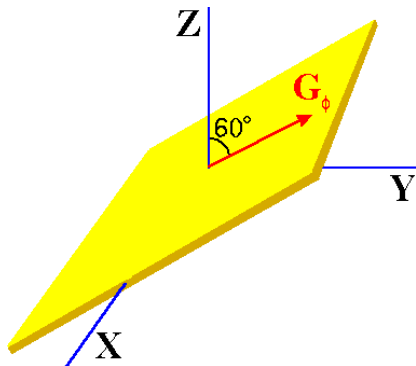

Slice orientation

- Slice orientation can be arbitrary — xy, yz, xz , or oblique
- All gradients change B_z . Using linear combination
- Slice selection gradient perpendicular to the slice plane
- Phase encoding gradient in the slice plane
- Frequency encoding gradient in the slice plane

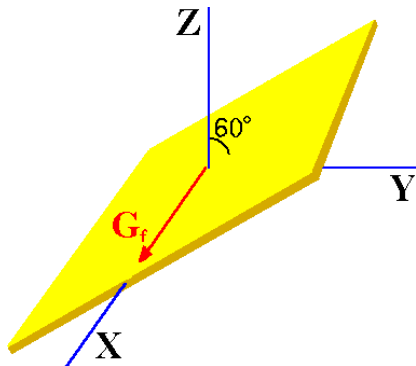

Slice orientation

- Slice orientation can be arbitrary — xy, yz, xz , or oblique
- All gradients change B_z . Using linear combination
- Slice selection gradient perpendicular to the slice plane
- Phase encoding gradient in the slice plane
- Frequency encoding gradient in the slice plane
- Gradient coils simultaneously on.

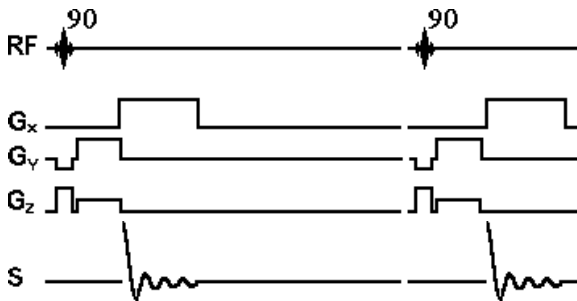

Excitation sequences

Free induction decay

Spin echo

Positional encoding

Frequency encoding

Slice selection

Phase encoding

Mathematics of Fourier encoding

Quadrature detector

Aliasing

Reconstruction

Spin packet signal

Received (complex) signal:

$$s(t) = M_x(t) + jM_y(t) \propto e^{-j\phi(t)}$$

with phase $\phi(t) = 2\pi ft$

substituting $f = \gamma B$:

$$\phi(t) = 2\pi\gamma Bt$$

Time-dependent magnetic field

Received (complex) signal:

$$s(t) \propto e^{-j\phi(t)}$$

for stationary field B :

$$\phi(t) = 2\pi\gamma Bt$$

for time dependent field $B(t)$:

$$\phi(t) = 2\pi\gamma \int B(t) dt$$

Effects of phase encoding

$$\phi(t) = 2\pi\gamma \int B(t) dt$$

$$B(t) = B_0 + G_\phi(t)y, \quad \phi(t) = 2\pi\gamma \int B_0 + G_\phi(t)y dt$$

phase shift due to a gradient :

$$\Delta\phi = 2\pi\gamma y \int G_\phi(t) dt$$

Effects of phase encoding (2)

Only the integral of $G_\phi(t)$ matters, not the shape:

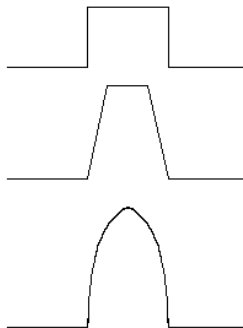

For rectangular pulse G_ϕ with duration τ_ϕ :

$$\Delta\phi = 2\pi\gamma y G_\phi \tau_\phi$$

Phase and frequency encoding

After phase encoding :

$$s(t) \propto e^{-2\pi j\gamma \int B_0 + G_\phi(t)y dt}$$

$$s(t) \propto e^{-2\pi j\gamma (B_0 t + G_\phi \tau_\phi y)}$$

After phase and frequency encoding :

$$s(t) \propto e^{-2\pi j\gamma (B_0 t + G_\phi \tau_\phi y + G_f t x)}$$

Quadrature Detector

- **Input:** RF coil signal
- **Output:** signals corresponding to magnetization $M_{x'}$, $M_{y'}$
- x' , y' is the rotating frame of reference

Quadrature Detector

- **Input:** RF coil signal
- **Output:** signals corresponding to magnetization $M_{x'}$, $M_{y'}$
- x' , y' is the rotating frame of reference

Motivation

- Lower frequency, easier to process
- We can determine *phase*, not only *amplitude* (as in standard AM detector)
- Output is $s(t) = M_{x'} + jM_{y'}$ is considered a *complex signal*

Quadrature Detector

- **Input:** RF coil signal
- **Output:** signals corresponding to magnetization $M_{x'}$, $M_{y'}$
- x' , y' is the rotating frame of reference

Motivation

- Lower frequency, easier to process
- We can determine *phase*, not only *amplitude* (as in standard AM detector)
- Output is $s(t) = M_{x'} + jM_{y'}$ is considered a *complex signal*

How?

- *product mixer* with a reference signal f_0

Product mixer

Doubly Balanced Mixer (DBM)

- *Input:* $g_a = \cos(at)$, $g_b = \cos(bt)$
- *Output:* $g = g_a g_b = \frac{1}{2} \cos((a + b)t) + \frac{1}{2} \cos((a - b)t)$
- Signal $\cos((a + b)t)$ can be filtered (low-pass filter)
- Difference frequency signal $\cos((a - b)t)$

Quadrature detector (2)

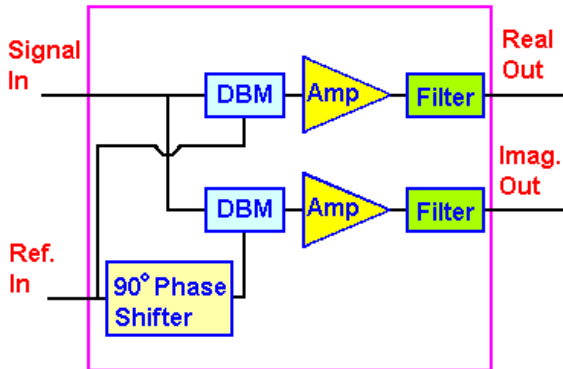

Quadrature detector in Fourier imaging

Signal

$$s(t) \propto e^{-2\pi j\gamma(B_0 t + G_\phi \tau_\phi y + G_f t x)}$$

Quadrature demodulation with $f_0 = \gamma B_0$ is like using the rotating coordinate system:

$$s(t) \propto e^{-2\pi j\gamma(G_\phi \tau_\phi y + G_f t x)}$$

k -space

Demodulated signal

$$s(t) \propto e^{-2\pi j\gamma(G_\phi\tau_\phi y + G_f t x)}$$

Substitution

$$k_x(t) = \gamma \int G_f(t) dx = \gamma G_f t \quad k_y(t) = \gamma \int G_\phi(t) dx = \gamma G_\phi \tau_\phi$$

$$s(t) \propto e^{-2\pi j(k_x(t)x + k_y(t)y)}$$

k -space, slice signal

Demodulated signal from one point:

$$s(t) \propto e^{-2\pi j(k_x(t)x + k_y(t)y)}$$

Signal from the whole slice:

$$s(t) \propto \int_{(x,y) \in \text{slice}} \rho(x,y) e^{-2\pi j(k_x(t)x + k_y(t)y)} dx dy$$
$$s(t) = S(k_x(t), k_y(t))$$

where $\rho(x, y)$ is the spin density.

Received signal $S(k_x, k_y)$ is a 2D Fourier transform of $\rho(x, y)$

k -space example

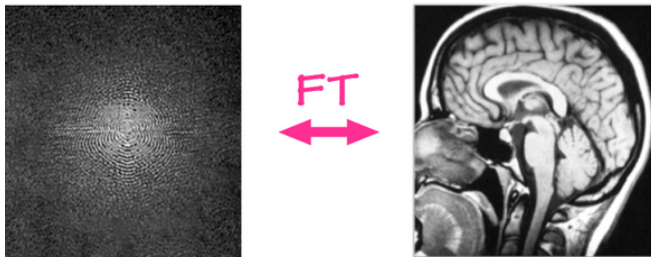

- $S(k_x, k_y)$ is a 2D Fourier transform of $\rho(x, y)$.
- Trajectory $(k_x(t), k_y(t))$ controlled by gradients
- We sample $S(k_x, k_y)$ at points $(k_x(t), k_y(t))$ to get samples from a 1D signal $s(t) = (k_x(t), k_y(t))$.

k-space sampling

k-space acquisition line by line

One line — one excitation

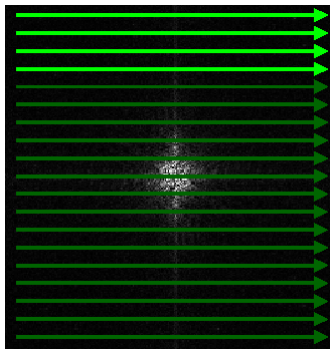

Other trajectories are possible and often used (e.g. spiral)

Trajectory is defined by the time course of the gradients $G_f(t)$,
 $G_\phi(t)$

Field of view (FOV)

- Sampling step in k -space

$$\Delta k_x = \gamma G_f t_{\text{samp}} \quad \Delta k_y = \gamma \Delta G_{\phi} \tau_{\phi}$$

- Shannon/Nyquist/Whittaker/Kotelnikov sampling theorem
→ imaged object must be smaller than

$$\text{FOV}_x = \frac{1}{\Delta k_x} = \frac{1}{\gamma G_f t_{\text{samp}}}$$

$$\text{FOV}_y = \frac{1}{\Delta k_y} = \frac{1}{\gamma \Delta G_{\phi} \tau_{\phi}}$$

(quadrature detector → complex sampling → factor 2)

- if the object is larger, aliasing (folded object)

Aliasing

(Wrap Around Effect)

- Part of the object outside of FOV will appear elsewhere
- Object too big, FOV too small

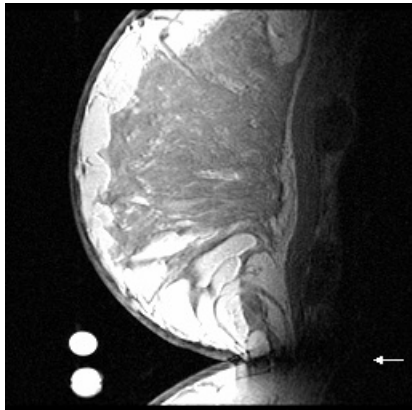

Aliasing (2)

- Aliasing in frequency encoding direction can be suppressed by:
 - Using higher f_{samp} , e.g. 2 MHz instead of 16 kHz. This reduces SNR.
 - Suppressing signal outside of FOV (e.g. using a smaller coil)
- Aliasing in phase encoding direction can be suppressed by:
 - reducing $\Delta k_y \rightarrow$ increase of the number of phase encoding steps (longer acquisition) or decreasing spatial resolution
 - Suppressing signal outside of FOV (e.g. using a smaller coil)
 - Changing the phase encoding direction

Slice reconstruction

- One active pixel

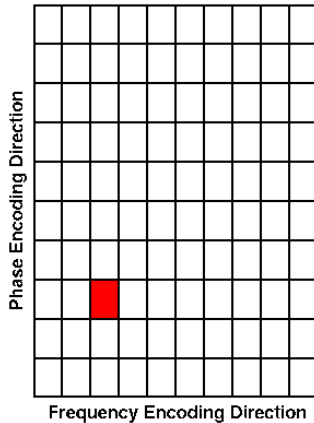

Slice reconstruction

- 10 excitations with different G_ϕ

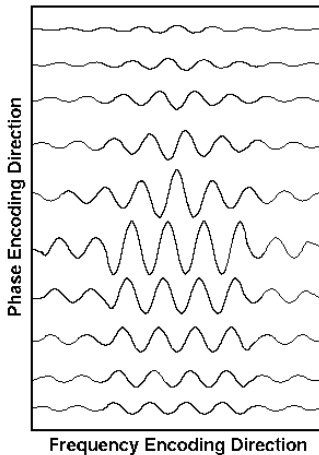

Slice reconstruction

- FT along x

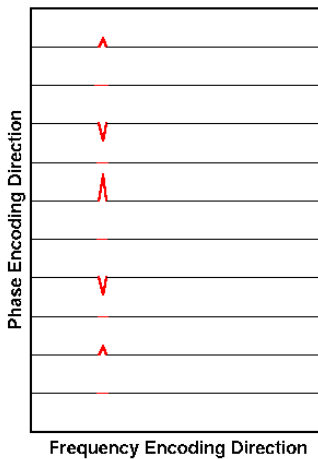

Slice reconstruction

- Finer sampling

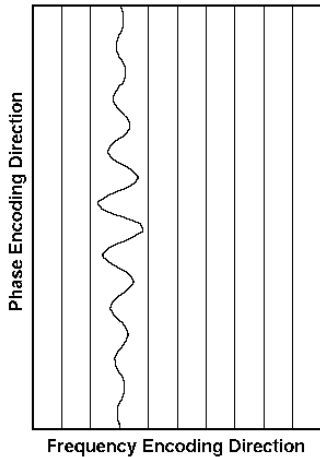

Slice reconstruction

- FT along y

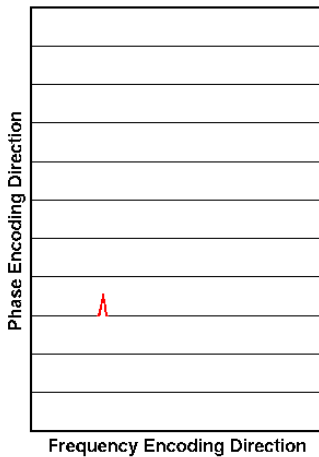

Slice reconstruction

- original

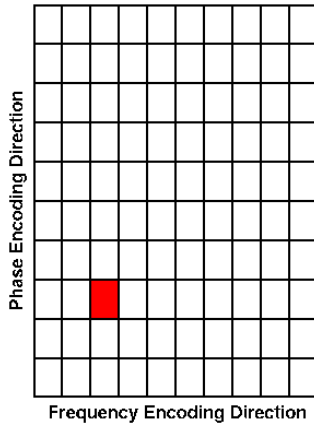

Visualization

- Show amplitude of the 2D FT signal as a grayscale image

