

Humanoid robots - Kinematics I

Mgr. Matěj Hoffmann, Ph.D.

Common kinematic arrangements of manipulators

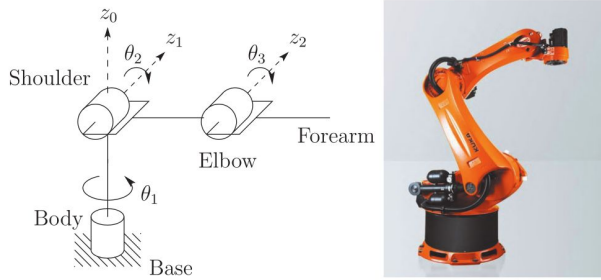

Articulated manipulator (RRR) - also called revolute, elbow, or anthropomorphic manipulator.

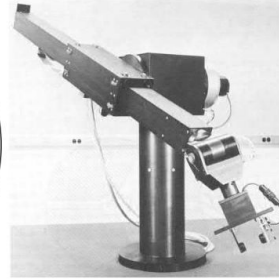
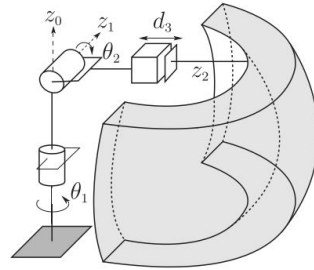

spherical manipulator (RRP) (Stanford arm) (SCARA is also RRP but different)

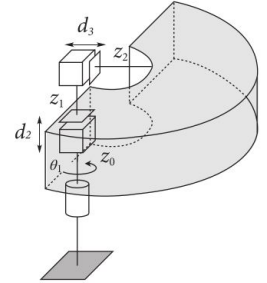

cylindrical manipulator (RPP)

What (I think) most of you already know from Robotics by V. Smutný (B3B33ROB1)

What does 'R' and 'P' stand for?

Which one will have simple forward and inverse kinematics?

Which one do you think is the most relevant for humanoids?

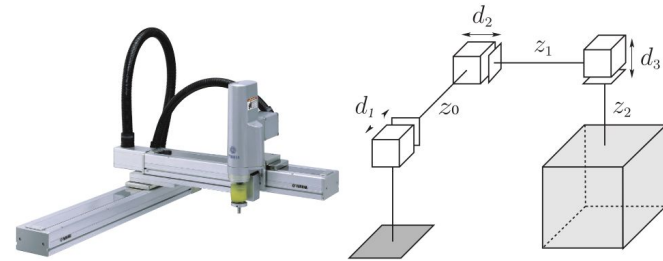

Cartesian manipulator (PPP)

Classification by kinematic type

[first 3 DoFs]

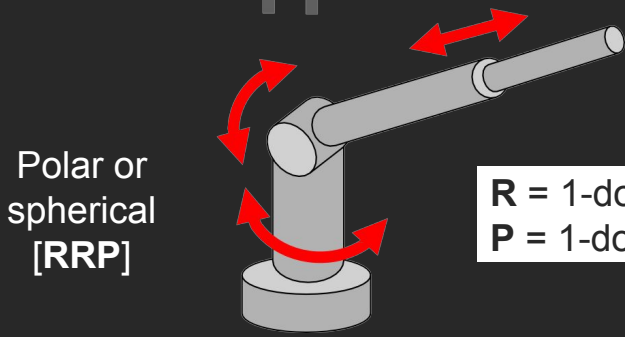
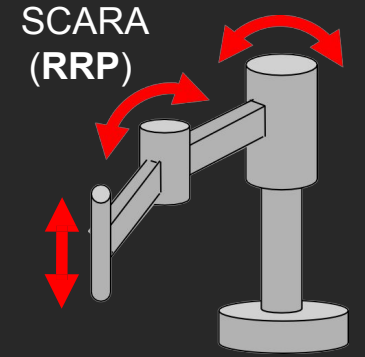
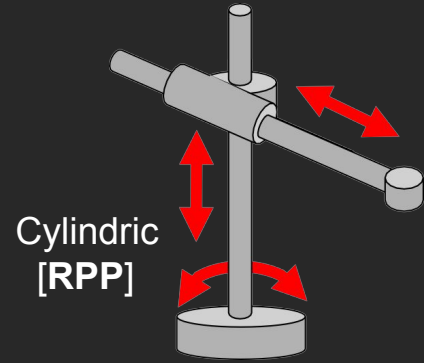
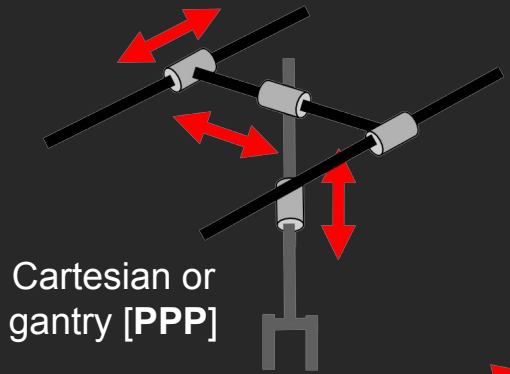

R = 1-dof rotational (**revolute**) joint
P = 1-dof translational (**prismatic**) joint

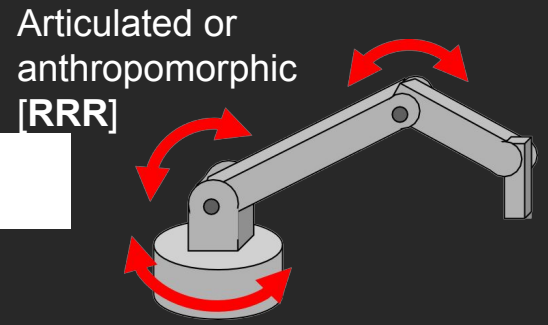

Types of joints – robots vs. humans?

- Which joint types are present in the human body? Prismatic, revolute, ...?
- In fact, there are more joint types:
- However, “In this book it is assumed throughout that all joints have only a single degree of freedom. This assumption does not involve any real loss of generality, since joints such as a ball and socket joint (two degrees of freedom) or a spherical wrist (three degrees of freedom) can always be thought of as a succession of single degree-of-freedom joints with links of length zero in between.” (Spong et al. 2020, pg. 76)

Joint type	dof f	Constraints c between two planar rigid bodies	Constraints c between two spatial rigid bodies
Revolute (R)	1	2	5
Prismatic (P)	1	2	5
Helical (H)	1	N/A	5
Cylindrical (C)	2	N/A	4
Universal (U)	2	N/A	4
Spherical (S)	3	N/A	3

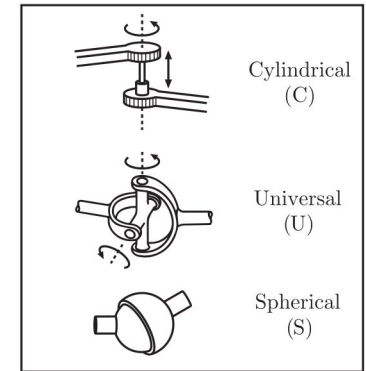
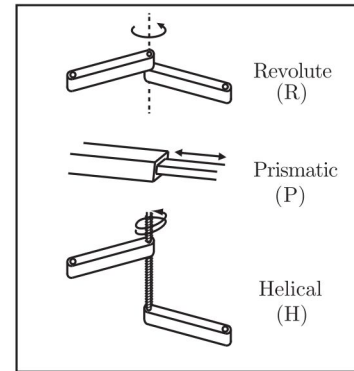

Table 2.1 and Figure 2.3 in Lynch, K. M., & Park, F. C. (2017). Modern robotics. Cambridge University Press.

Shoulder joint

Human shoulder joint

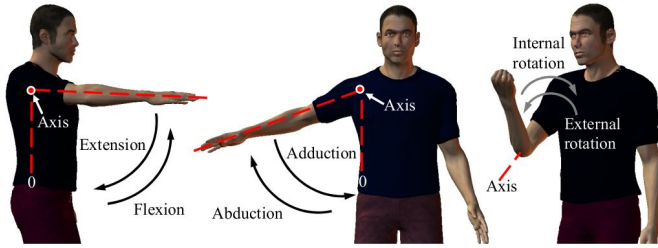
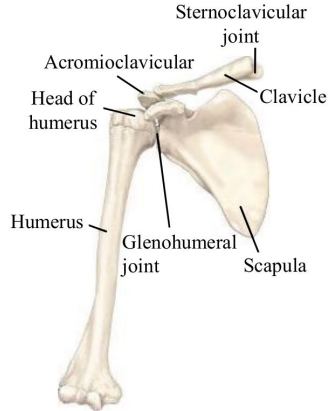

Figure 2.3 in Gopura, R. A. R. C. (2009). *Development and control of upper-limb exoskeleton robots* (Doctoral dissertation).

iCub shoulder assembly - traditional engineering solution - 3 DoF via sequence of 3 revolute joints.

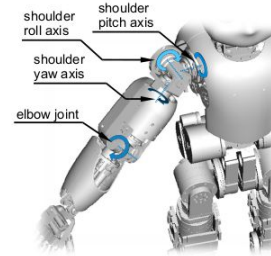
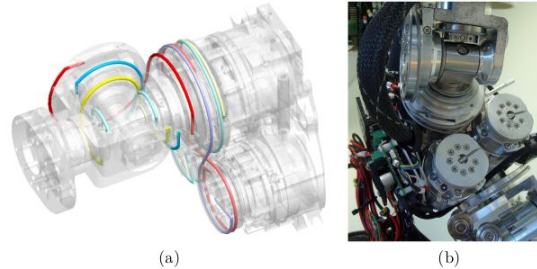

Fig. 4. The iCub arm. The figure represents a CAD view of the arm of the iCub and its three DOF shoulder joint and one DOF elbow joint.



Parmiggiani, A., Maggiali, M., Natale, L., Nori, F., Schmitz, A., Tsagarakis, N., ... & Metta, G. (2012). The design of the iCub humanoid robot. *International journal of humanoid robotics*, 9(04), 1250027.

spherical joint prototype



Folgheraiter, M., Yessirkepov, S., & Yessaly, A. (2019). An actuated spherical joint for humanoid robotics applications. In *2019 IEEE International Conference on Cybernetics and Intelligent Systems (CIS) and IEEE Conference on Robotics, Automation and Mechatronics (RAM)* (pp. 571-576). IEEE.

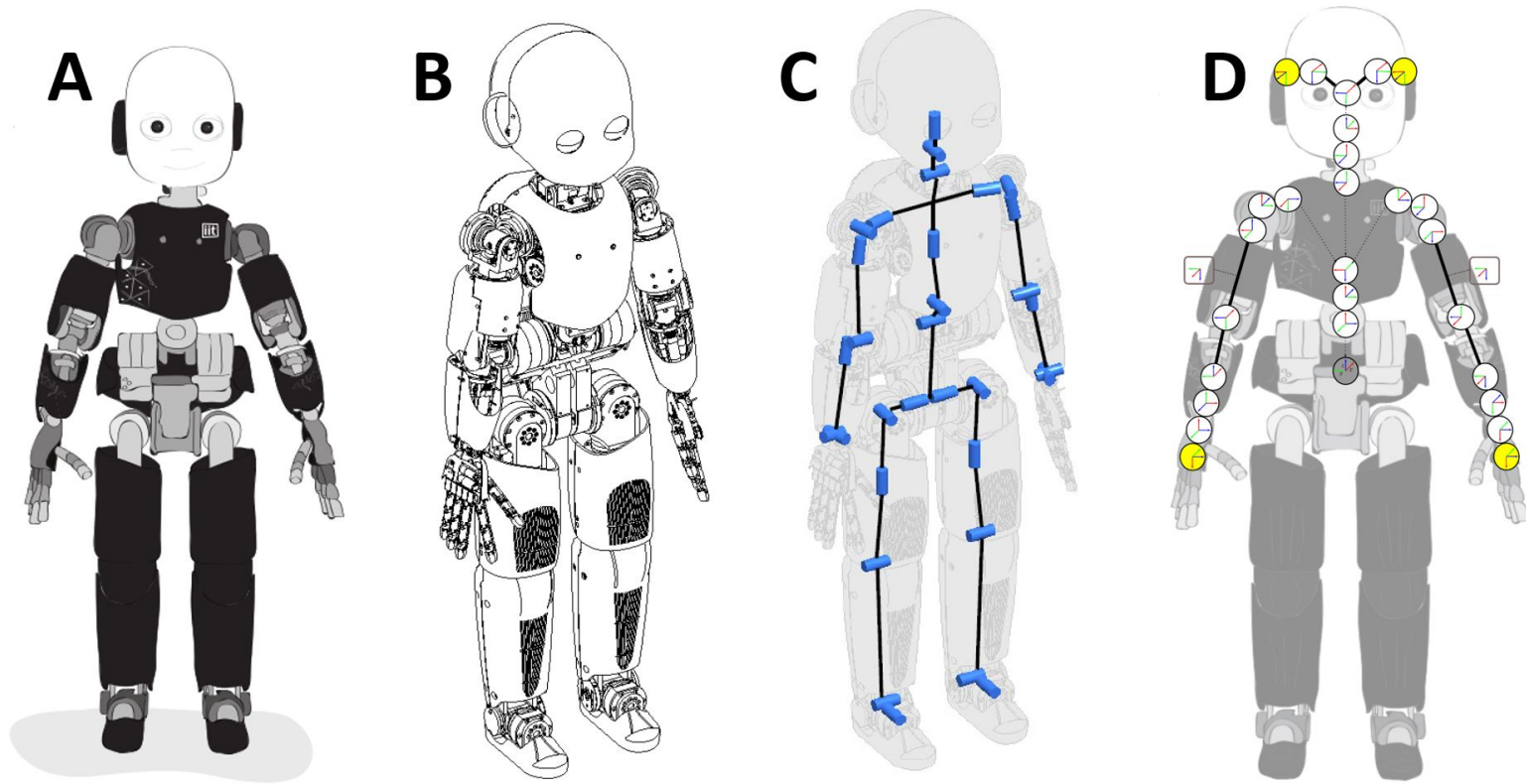

Figure 10.1 The iCub humanoid robot. (A) Cartoon of the robot. (B) CAD model. (C) Kinematic structure. (D) Reference frames in upper body.

Image credits: (A) iCub cartoon: Reproduced courtesy of Laura Taverna, Italian Institute of Technology. (B) (C) iCub kinematic structure: Reproduced with permission from (Parmiggiani, et al., 2012), and courtesy of Alberto Parmiggiani. (D) Reproduced courtesy of Jorhabib Eljaik.

Hoffmann, M. (2021). Body models in humans, animals, and robots: mechanisms and plasticity. *Body Schema and Body Image: New Directions*, 152.

Humanoid robot kinematics

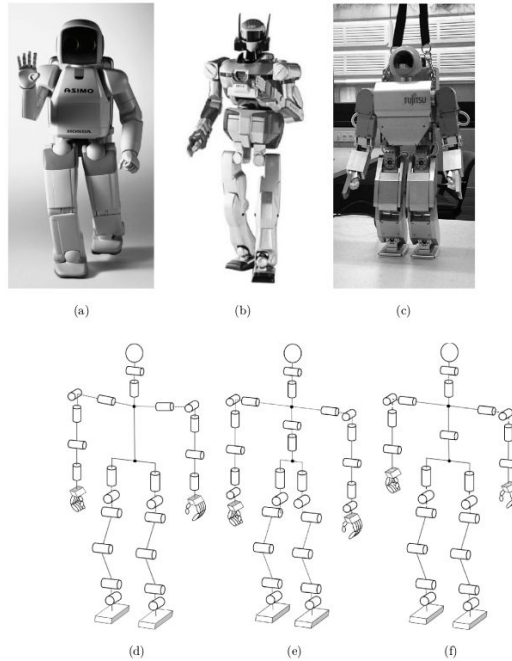
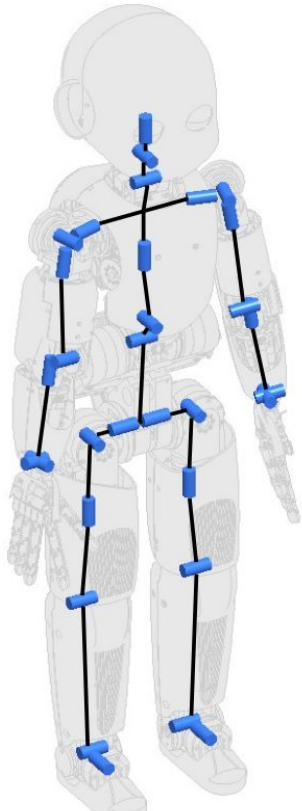

Fig. 4. (a) HONDA ASIMO Robot and its associated kinematic diagram in (d), (b) AIST HRP-2 Robot and its associated kinematic diagram in (e), and (c) Fujitsu HOAP-2 Robot and its associated kinematic diagram in (f).

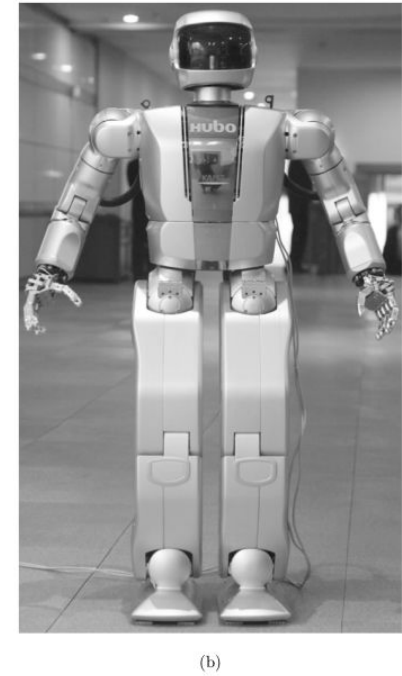
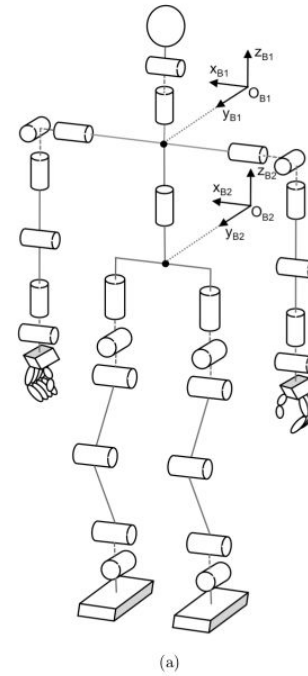

Fig. 1. A Hubo KHR-4 Humanoid Robot.

Table 1. Degrees of Freedom of a Hubo KHR-4 Humanoid Robot.

Head	Waist	Arm	Hand	Leg	Total
2/Neck	1/Waist	3/Shoulder	5/Hand	3/Hip	—
2/Eyes	—	1/Elbow	—	1/Knee	—
—	—	2/Wrist	—	2/Ankle	—
6 DOF	1 DOF	12 DOF	10 DOF	12 DOF	41 DOF

Park, H. A., Ali, M. A., & Lee, C. G. (2012). Closed-form inverse kinematic position solution for humanoid robots. *International Journal of Humanoid Robotics*, 9(03), 1250022.

Parmiggiani, A., Maggiali, M., Natale, L., Nori, F., Schmitz, A., Tsagarakis, N., ... & Metta, G. (2012). The design of the iCub humanoid robot. *International journal of humanoid robotics*, 9(04), 1250027.

Traditional design but new actuators?

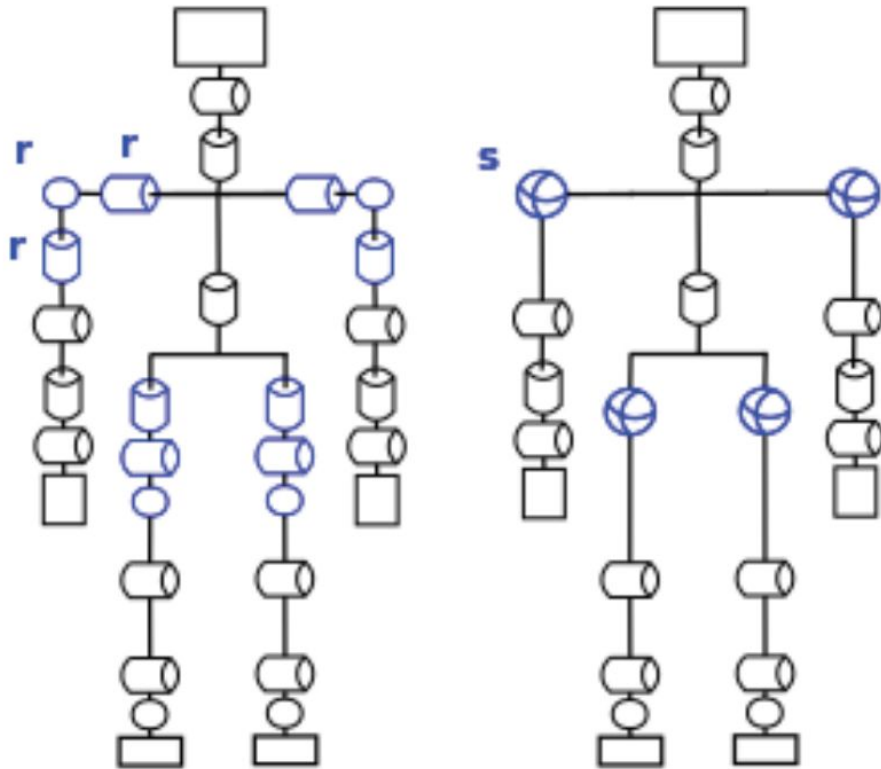

spherical joint prototype



Folgheraiter, M., Yessirkepov, S., & Yessaly, A. (2019). An actuated spherical joint for humanoid robotics applications. In *2019 IEEE International Conference on Cybernetics and Intelligent Systems (CIS) and IEEE Conference on Robotics, Automation and Mechatronics (RAM)* (pp. 571-576). IEEE.

Muscles vs. motors

Force production / motor mass ratio may be comparable (Marden & Allen 2002)

- force production to accomplish steady translational motion of a load (myosin, kinesin, dynein, and RNA polymerase molecules, muscle cells, whole muscles, winches, **linear actuators**, and rockets) have maximal force outputs that scale as the two-thirds power of mass, i.e., with cross-sectional area.
- Motors that use cyclical motion to generate force have maximal force outputs that scale as a single isometric function of motor mass. Examples of this class of motors includes flying birds, bats, and insects, swimming fish, various taxa of running animals, piston engines, **electric motors**, and all types of jets.

Marden, James H., and Lee R. Allen. "Molecules, muscles, and machines: universal performance characteristics of motors." *Proceedings of the National Academy of Sciences* 99.7 (2002): 4161-4166.

But the geometry and “philosophy” of actuation is different.

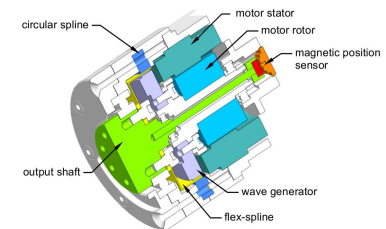
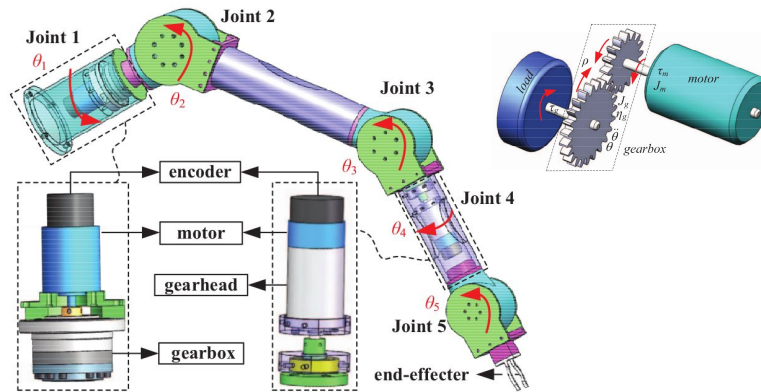
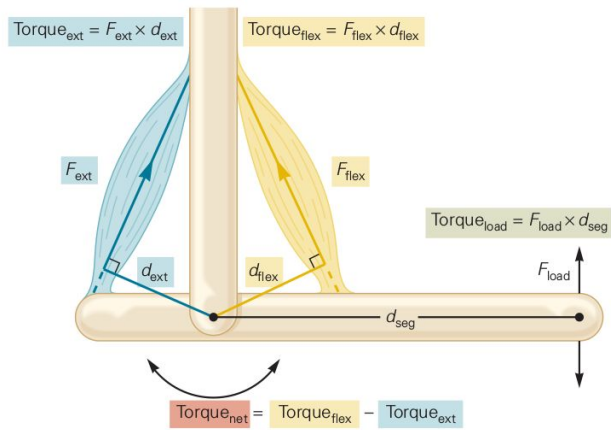

iCub motor unit (Parmiggiani et al. 2012)

Yin, H., Huang, S., He, M., & Li, J. (2016, June). An overall structure optimization for a light-weight robotic arm. In *2016 IEEE 11th Conference on Industrial Electronics and Applications (ICIEA)* (pp. 1765-1770). IEEE.

What is different?

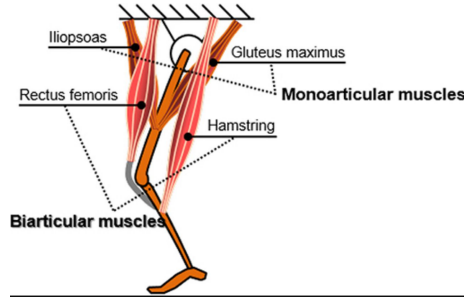
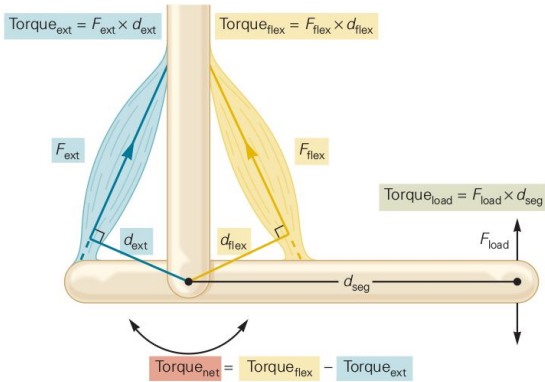

Lee, C., & Oh, S. (2019). Development, analysis, and control of series elastic actuator-driven robot leg. *Frontiers in neurorobotics*, 13, 17.

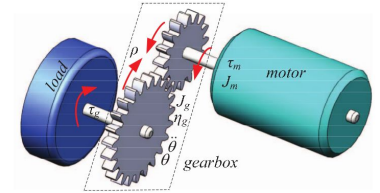
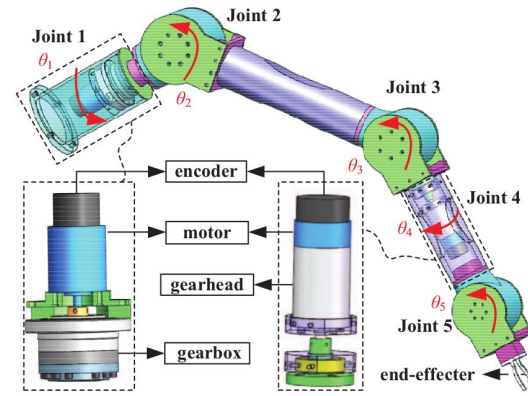

Muscle is a linear actuator that can only contract.

Rotary motion produced through lever arms.

Agonist / antagonist pairs.

More force ~ recruitment of more muscle fibers.

Relatively slow action.

Complicated geometry (lever arm changes during contraction; biarticular muscles...).

Electric rotary motors rotate in two directions (changing magnetic field) and directly drive a revolute joint.

Force ~ electric current. Speed ~ voltage.

Motor speed very fast. Gearbox needed (speed / torque trade off).

Musculoskeletal robots



ECCE (<https://youtu.be/cl9H4FoA0b4>)

Wittmeier, S., Alessandro, C., Bascarevic, N., Dalamagkidis, K., Devereux, D., Diamond, A., ... & Holland, O. (2013). Toward anthropomimetic robotics: development, simulation, and control of a musculoskeletal torso. *Artificial life*, 19(1), 171-193.

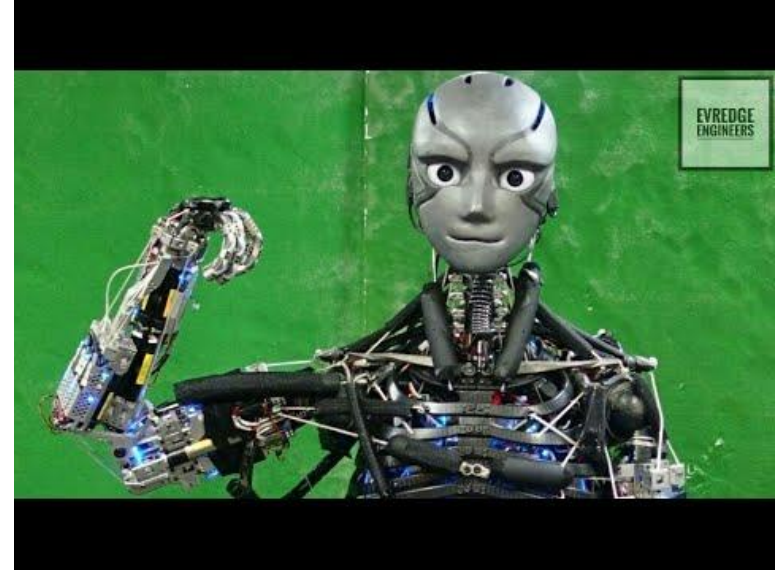

Kotaro (2006), Kojiro (2007), Kenshiro (2012), Kengoro (2016) <https://youtu.be/z6tKWY6odRw>

Asano, Y., Okada, K., & Inaba, M. (2017). Design principles of a human mimetic humanoid: Humanoid platform to study human intelligence and internal body system. *Science Robotics*, 2(13), eaaq0899.

Conventional style humanoid Human mimetic style humanoid

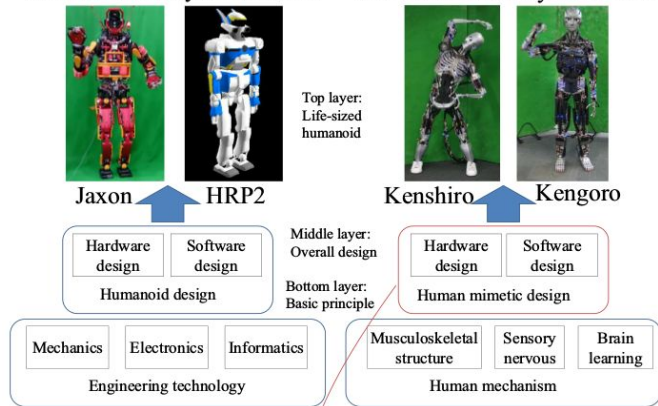

Human mimetic design principle

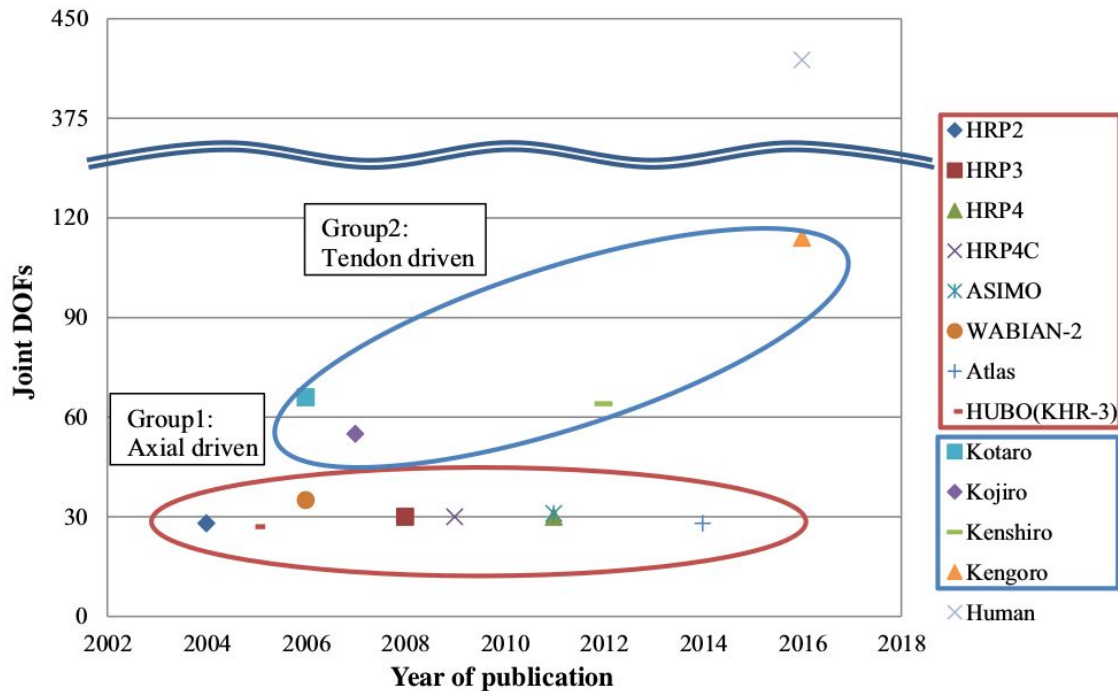
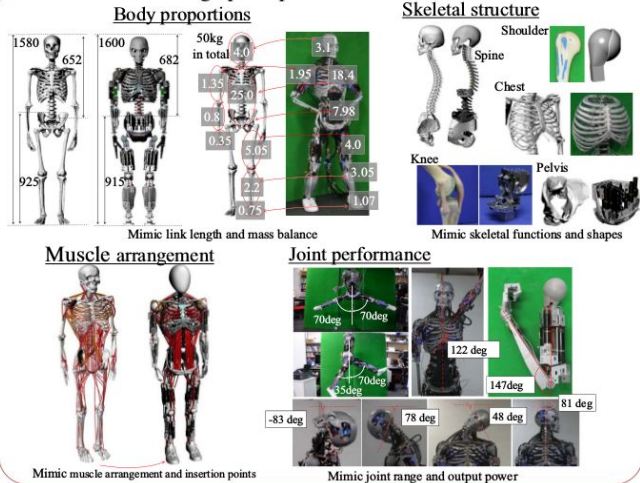

Asano, Y., Okada, K., & Inaba, M. (2017). Design principles of a human mimetic humanoid: Humanoid platform to study human intelligence and internal body system. *Science Robotics*, 2(13), eaaq0899.

Musculoskeletal robots – electric motors driving elastics



Figure 7. Roby, a human-like, musculoskeletal robot with 28 degrees of freedom and 48 motors, to be controlled by brain-inspired systems. (Photograph courtesy of Adrian Baer.)

ECCE (ECCE 1 - 2009)

Roby

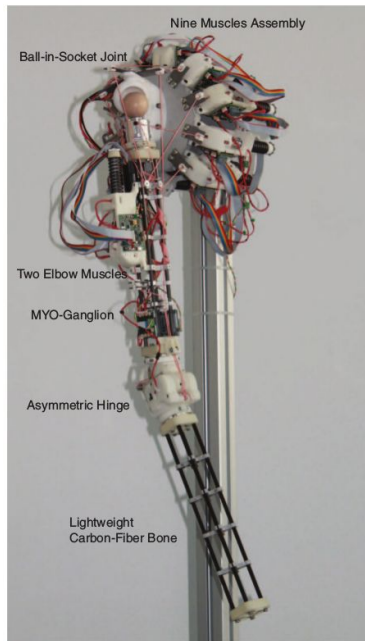

Figure 1. The complex Myorobotics arm mimicking the complexity of a human arm without spatula. Nine muscles cooperate to control the ball-in-socket joint. One of these muscles, relating to the biceps, is biarticular, as it is attached so that it affects the motion of two joints, effectively coupling the shoulder and elbow joint.

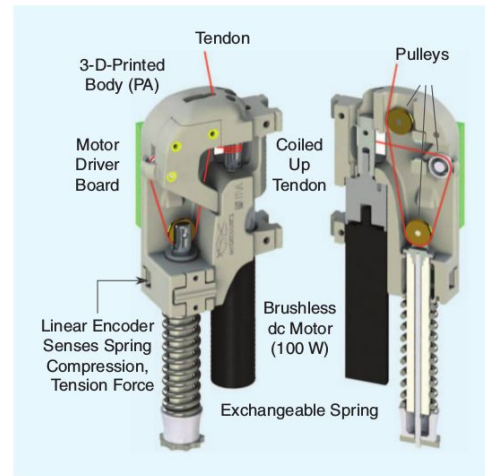

Figure 2. The Myorobotics muscle with its components. The tendon (red cable) is routed in a triangular fashion in the muscle to create a nonlinear net spring force. The tendon force is sensed by measuring the spring displacement through a magnetic strip fixed to the guiding rod of the spring that slides by a hall-effect encoder. This allows calculation of the respective force from a known spring constant and tendon routing geometry.

Richter, C., Jentzsch, S., Hostettler, R., Garrido, J. A., Ros, E., Knoll, A., ... & Conradt, J. (2016). Musculoskeletal robots: scalability in neural control. *IEEE Robotics & Automation Magazine*, 23(4), 128-137.

Musculoskeletal robots – pneumatic actuators



<https://youtu.be/exSKkvqbBL8>

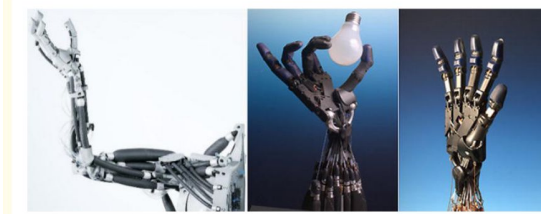

Figure 3.
The bionic musculoskeletal robots of the FESTO Airic's arm and the SHADOW hand [5, 6].

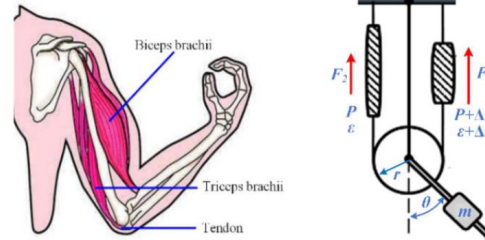
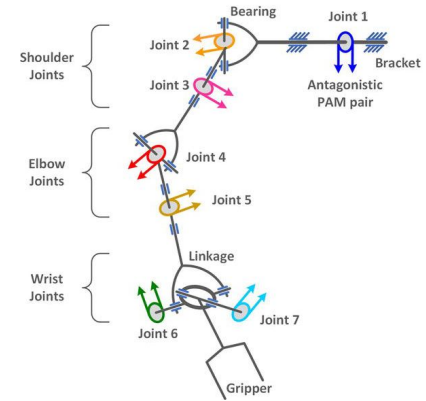

Figure 2.
The antagonistic muscles-driven strategy: (a) The human joint; (b) the robotic joint actuated by PAMs via steel wire cables.



Gong, D., & Yu, J. (2022). Design and Control of the McKibben Artificial Muscles Actuated Humanoid Manipulator.

Which design is best? Depends on the goal...



Most recently developed bipedal humanoid robots with a full humanoid body plan, from left to right, top to bottom: Asimo, Atlas, Atlas-Unplugged, Digit, HRP-3P, Hydra, Kengoro, NimbRo-OP2X, TALOS, Toro, Valkyrie, WALK-MAN

Ficht, G., & Behnke, S. (2021). Bipedal humanoid hardware design: A technology review. *Current Robotics Reports*, 2(2), 201-210.

BOX 45.2 Humanoid embodiment for modeling cognition

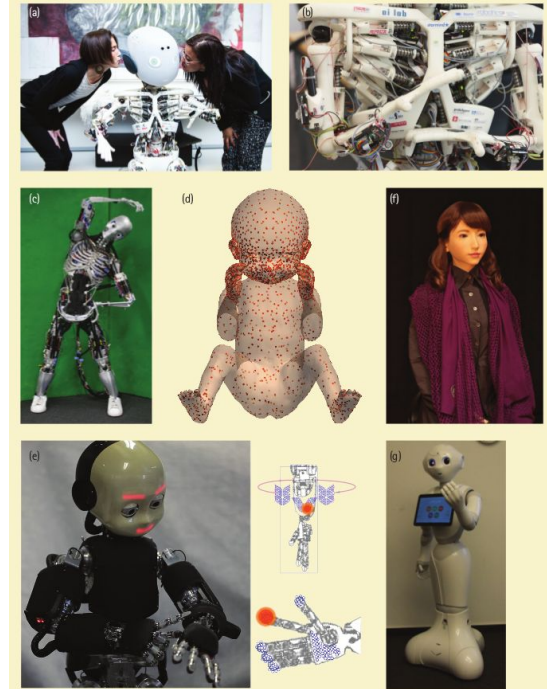

FIGURE 45.2. Humanoid robots.

Hoffmann, M. & Pfeifer, R. (2018), Robots as powerful allies for the study of embodied cognition from the bottom up, in A. Newen, L. de Bruin, & S. Gallagher, ed., 'The Oxford Handbook 4e Cognition', Oxford University Press, pp. 841-861.

Name	Height	Weight	Actuation	No. of	Sensing	Manufacture	Year	Tentative
	(cm)	(kg)		actuators				price
Asimo (2011 model)	130	48	Electric	57	Joints: position	Magnesium	2011	2500000 USD
			Harmonic Drive		IMU, 2x F/T, Camera	alloy		
Atlas (Next Generation)	150	75	Hydraulic	28	Joints: position, force	Metal,	2016	N/A
			Servo-valves		Lidar, Stereo vision	3D-printed		
Atlas-Unplugged	188	182	Hydraulic	30	Joints: position, force	Aluminium	2015	2000000 USD
			Servo-valves		Lidar, Stereo vision	Titanium		
Digit	155	42.2	Electric	16	Joints: position	Aluminium, milled	2019	250000 USD
			Cycloid Drive		IMU, Lidar, 4x Depth Cam.	Carbon fiber		
HRP-5P	183	101	Electric	37	Joints: position	Metal	2018	N/A
			Harmonic Drive		4x F/T, IMU, Lidar	(unspecified)		
					Stereo Vision			
Hydra	185	135	Hydraulic	41	Joints: position, force	Aluminium	2016	N/A
			EHA		IMU, 2x F/T, Lidar, Stereo	milled		
Kengoro	167	55.9	Electric	106	Joints: position, tension	Aluminium	2016	N/A
			Muscle /w Tendons		IMU, 2x F/T, Stereo Vision	3D-printed		
NimbRo-OP2(X)	135	19	Electric	34	Joints: position	PA12 Nylon	2017	25000 EUR
			DC Servo-motors		IMU, Stereo Vision	3D-printed		
TALOS	175	95	Electric	32	Joints: position, torque	Metal	2017	900000 EUR
			Harmonic Drive		IMU, RGBD camera	(unspecified)		
Toro	174	76.4	Electric	39	Joints: position, torque	Aluminium	2014	N/A
			Harmonic Drive		2x IMU, RGB&D cameras	milled		
Valkyrie	187	129	Electric	44	Joints: position, force, torque	Metal	2013	2000000 USD
			SEA		7x IMU, 2xF/T, Multiple cameras	(unspecified)		
WALK-MAN	191	132	Electric	29	Joints: position, torque	Aluminium	2015	N/A
			SEA		2x IMU, 4x F/T, Lidar	milled		
					Stereo Vision			

Ficht, G., & Behnke, S. (2021). Bipedal humanoid hardware design: A technology review. *Current Robotics Reports*, 2(2), 201-210.

Which design is best? Depends on the goal...

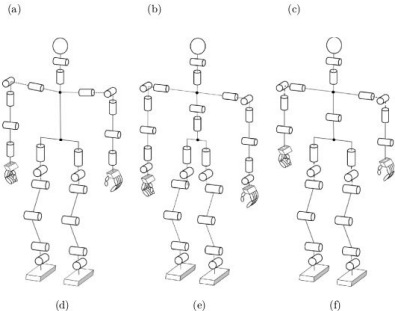
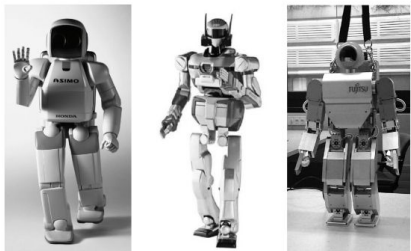

Fig. 4. (a) HONDA ASIMO Robot and its associated kinematic diagram in (d), (b) AIST HRP-2 Robot and its associated kinematic diagram in (e), and (c) Fujitsu HOAP-2 Robot and its associated kinematic diagram in (f).

Park, H. A., Ali, M. A., & Lee, C. G. (2012). Closed-form inverse kinematic position solution for humanoid robots. *International Journal of Humanoid Robotics*, 9(03), 1250022.

“The initial dimensions, kinematic layout and ranges of movement were drafted by considering biomechanical models and anthropometric tables. Rigid body simulations allowed to determine which were the crucial kinematic features of the human body to be replicated in order to perform the set of desired tasks and motions. These simulations also provided joint torques requirements: these data were then used as a baseline for the selection of the robot’s actuators.”

Parmiggiani, A., Maggiali, M., Natale, L., Nori, F., Schmitz, A., Tsagarakis, N., ... & Metta, G. (2012). The design of the iCub humanoid robot. *International journal of humanoid robotics*, 9(04), 1250027.

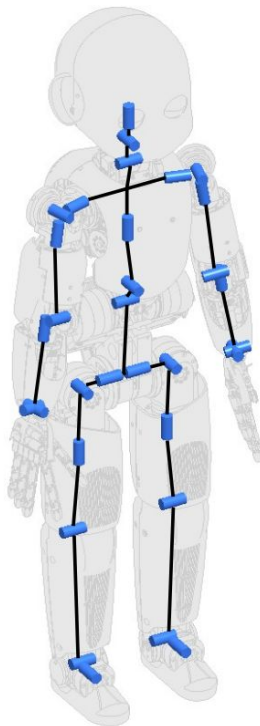

Figure 7. Roby, a human-like, musculoskeletal robot with 28 degrees of freedom and 48 motors, to be controlled by brain-inspired systems. (Photograph courtesy of Adrian Baer.)

Popular choice.
Rigid, electrically actuated. Approximate kinematic similarity to humans, but traditional design.

Close inspiration in kinematics but engineering design.
Rigid, electrically actuated.

Mimicking biomechanics as closely as possible.

Traditional modeling and control can be applied.

Traditional modeling and control can hardly be applied.
Why?
Brain-like motor control is needed, but not ready.¹⁷

“Traditional humanoids” – rigid bodies, electrical motors...

Let's leave the musculoskeletal robots aside for a while...

Forward kinematics

- Denavit-Hartenberg representation

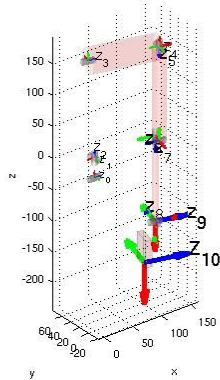

Here is the table of the actual DH parameters for left arm v2.

Link i / H - D	A _i (mm)	d _i (mm)	alpha _i (rad)	theta _i (deg)
i = 0	32	0	pi/2	-22 -> 84
i = 1	0	-5.5	pi/2	-90 + (-39 -> 39)
i = 2	23.3647	-143.3	-pi/2	105 + (-59 -> 59)
i = 3	0	107.74	-pi/2	90 + (5 -> -95)
i = 4	0	0	pi/2	-90 + (0 -> 160.8)
i = 5	15	152.28	-pi/2	75 + (-37 -> 100)
i = 6	-15	0	pi/2	5.5 -> 106
i = 7	0	141.3	pi/2	-90 + (-50 -> 50)
i = 8	0	0	pi/2	90 + (10 -> -65)
i = 9	62.5	225.98	0	(-25 -> 25)

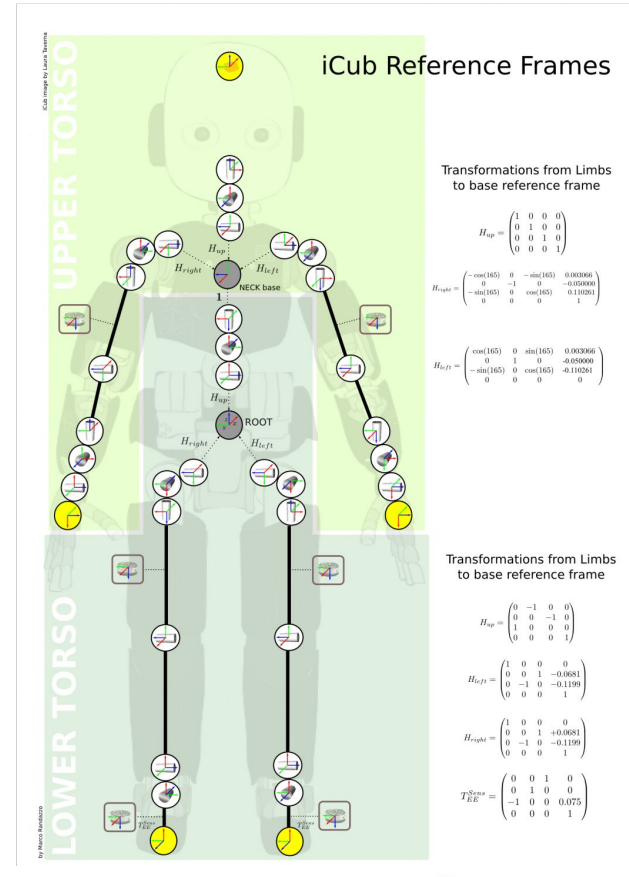

Humanoid kinematics

- What is different from manipulators?

There are multiple kinematic chains forming a tree-like structure.

- pelvis link as the global root link
- connected via a virtual 6-DoF joint to the ground
 - Robot has a *floating-base* - the base link moves in 3D space like a free rigid body.
- Kinematic chain is *structurally varying*.
 - Robot standing - two feet connect to the ground via temporary *contact joints*, forming closed loops within the chain.

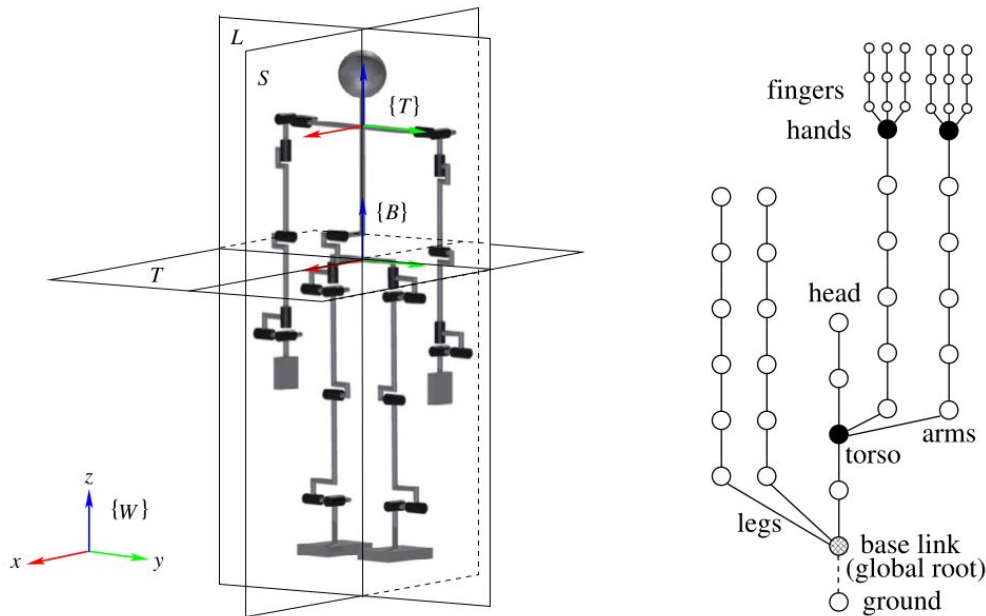

Reference frames

- inertial frame $\{W\}$ - attached to the ground
- base (root) link $\{B\}$ - pelvis
- torso link $\{T\}$ - “local” root for arms and head (in iCub: base \equiv root)

Mapping between frames - forward kinematics

Robot tasks are defined w.r.t. the inertial frame embedded into the environment (frame $\{W\}$ in Fig. 2.1A). Then, the 6D position of the controlled bodies (the end links of the limbs) has to be expressed in the inertial frame. This is done via the rigid-body motion transform ${}^W X_B$. For example, to obtain the 6D position of the hands in $\{W\}$, premultiply (2.1) from the left by ${}^W X_B$, i.e.

$${}^W X_{H_j} = {}^W X_B {}^B X_T {}^T X_{H_j}.$$

How do you do it when ...

- the robot is standing?
- the robot makes several steps?
- jumps?

Imagine a task “grab a cup from the table”. How would a human do it?

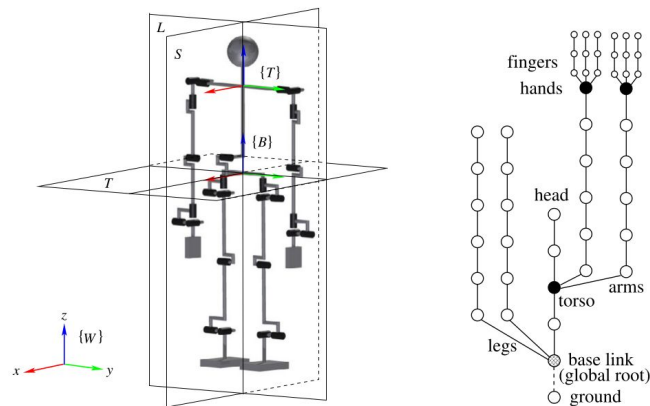

Multiple kinematic chains

End links / end effectors? How many?

- Hands
- Head
- Feet
- Anything... skin...

Can you control each of them independently?

No. Why not?

- shared joints - (e.g. torso)
- self-collisions
- balance

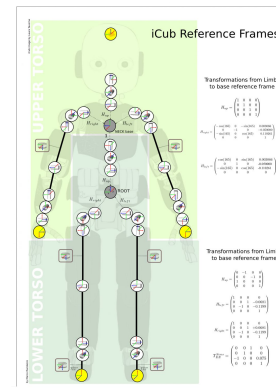
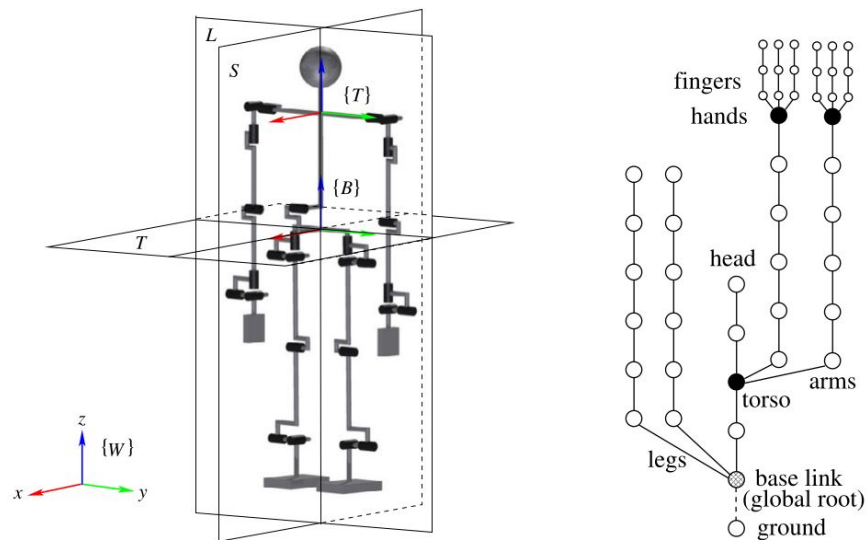

Inverse kinematics - closed form - 2 DoF planar arm

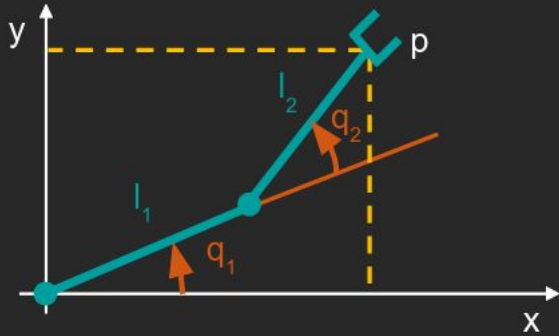

FK: $p_x = l_1 c_1 + l_2 c_{12}$
 $p_y = l_1 s_1 + l_2 s_{12}$

Squaring and summing the equations:

$$p_x^2 + p_y^2 - (l_1^2 + l_2^2) = 2l_1 l_2 (c_1 c_{12} + s_1 s_{12}) = 2l_1 l_2 c_2$$

$$c_2 = \frac{p_x^2 + p_y^2 - l_1^2 - l_2^2}{2l_1 l_2}$$

$$s_2 = \pm \sqrt{1 - c_2^2}$$

$$q_2 = \tan^{-1} \left(\frac{s_2}{c_2} \right)$$

Inverse kinematics - closed form - 2 DoF planar arm

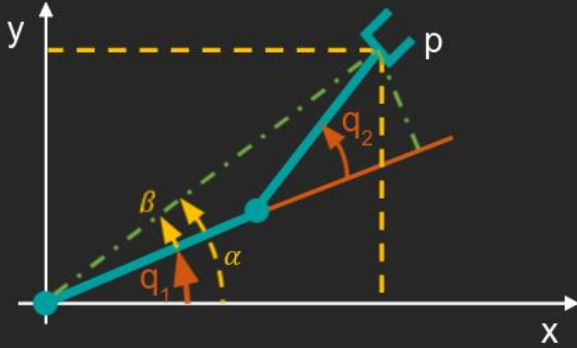

FK: $p_x = l_1 c_1 + l_2 c_{12}$
 $p_y = l_1 s_1 + l_2 s_{12}$

By geometric inspection: $q_1 = \alpha - \beta$

↓

$$q_1 = \tan^{-1}\left(\frac{p_y}{p_x}\right) - \tan^{-1}\left(\frac{l_2 s_2}{l_1 + l_2 c_2}\right)$$

$$q_2 = \tan^{-1}\left(\frac{s_2}{c_2}\right)$$

$$c_2 = \frac{p_x^2 + p_y^2 - l_1^2 - l_2^2}{2l_1 l_2}$$

$$s_2 = \pm \sqrt{1 - c_2^2}$$

Inverse kinematics - closed form - 2 DoF planar arm

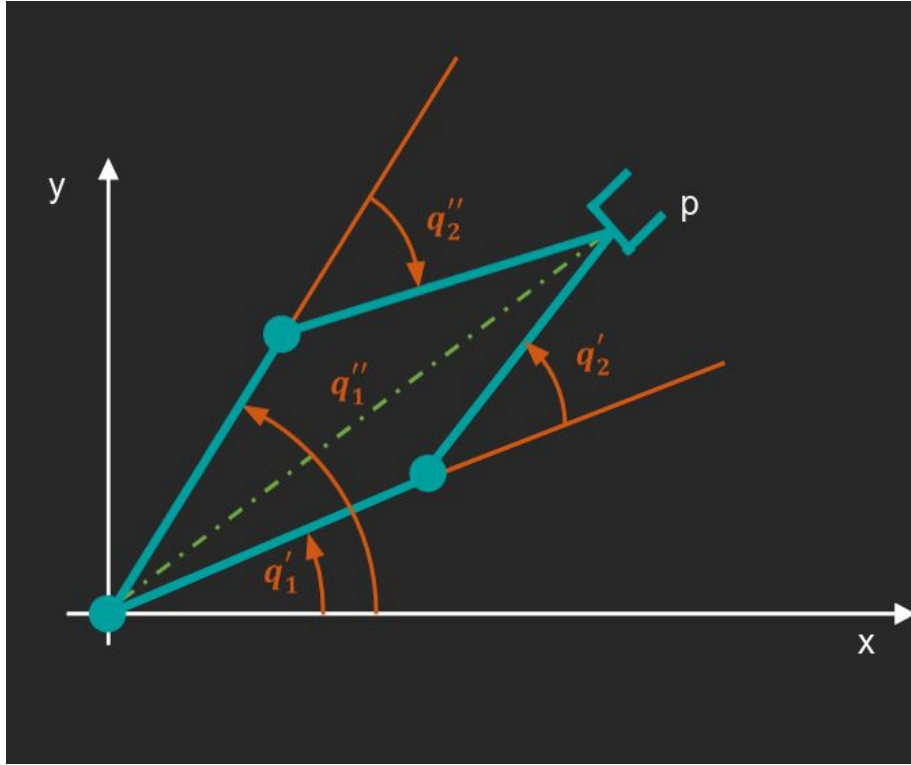

Two solutions! One for each value of s_2

q_2' and q_2'' have same absolute value, but different sign

Great video about IK:
<https://www.youtube.com/watch?v=IKOGwoJ2HLk>

Inverse kinematics - closed form - 2 DoF planar arm

Algebraic solution for q_1

$$\left. \begin{aligned} p_x &= l_1 c_1 + l_2 c_{12} = l_1 c_1 + l_2 (c_1 c_2 - s_1 s_2) \\ p_y &= l_1 s_1 + l_2 s_{12} = l_1 s_1 + l_2 (s_1 c_2 + c_1 s_2) \end{aligned} \right\} \text{linear in } s_1 \text{ and } c_1$$

$$\begin{bmatrix} p_x \\ p_y \end{bmatrix} = \begin{bmatrix} l_1 + l_2 c_2 & -l_2 s_2 \\ l_2 s_2 & l_1 + l_2 c_2 \end{bmatrix} \begin{bmatrix} c_1 \\ s_1 \end{bmatrix}$$

$$\det = l_1^2 + l_2^2 + 2 l_1 l_2 c_2 > 0$$

except for $l_1=l_2$ and $c_2=-1$ being then q_1 undefined

(singular case: $q_2 = -\pi \rightarrow \infty^1$ solutions)

$$q_1 = \tan^{-1} \left(\frac{s_1}{c_1} \right) = \tan^{-1} \left(\frac{(p_y(l_1 + l_2 c_2) - p_x l_2 s_2) / \det}{[p_x(l_1 + l_2 c_2) + p_y l_2 s_2] / \det} \right)$$

Inverse kinematics - closed form - 6 DoF arm

- Closed-form solution exists if:
 - 3 consecutive rotational joint axes are incident (e.g., spherical wrist), or
 - 3 consecutive rotational joint axes are parallel
- **Kinematic decoupling** - the position and orientation tasks can be considered independently.

“Since most six-DOF manipulator designs are kinematically simple, usually consisting of one of the five basic configurations of Chapter 1 with a spherical wrist, the geometric approach is simple and effective. Indeed, it is partly due to the difficulty of the general inverse kinematics problem that manipulator designs have evolved to their present state.”

6R example: PUMA 600

spherical wrist

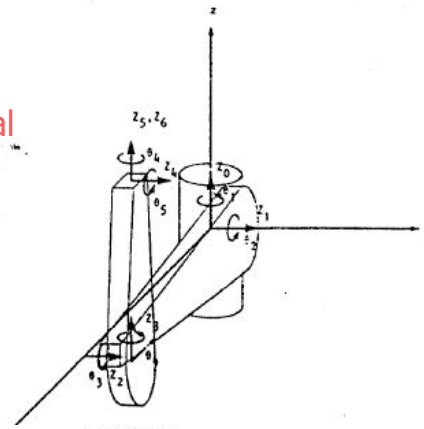

TABLE I
LINK PARAMETERS FOR PUMA ARM

Joint	α°	θ°	d	a	Range
1	-90°	θ_1	0	0	$\theta_1: +/ - 160^\circ$
2	0	θ_2	0	a_2	$\theta_2: +45^\circ - -225^\circ$
3	90°	θ_3	d_3	a_3	$\theta_3: 225^\circ - -45^\circ$
4	-90°	θ_4	d_4	0	$\theta_4: +/ - 170^\circ$
5	90°	θ_5	0	0	$\theta_5: +/ - 135^\circ$
6	0	θ_6	0	0	$\theta_6: +/ - 170^\circ$
$a_2 = 17.000$		$a_3 = 0.75$			
$d_3 = 4.937$		$d_4 = 17.000$			

$$\left. \begin{aligned} n_x &= C_1[C_{23}(C_4C_5C_6 - S_4S_6) - S_{23}S_5C_6] \\ &\quad - S_1[S_4C_5C_6 + C_4S_6] \\ n_y &= S_1[C_{23}(C_4C_5C_6 - S_4S_6) - S_{23}S_5C_6] \\ &\quad + C_1[S_4C_5C_6 + C_4S_6] \\ n_z &= -S_{23}(C_4C_5C_6 - S_4S_6) - C_{23}S_5C_6 \end{aligned} \right\} n = {}^0x_6(q)$$

$$\left. \begin{aligned} o_x &= C_1[-C_{23}(C_4C_5S_6 + S_4C_6) + S_{23}S_5S_6] \\ &\quad - S_1[-S_4C_5S_6 + C_4C_6] \\ o_y &= S_1[-C_{23}(C_4C_5S_6 + S_4C_6) + S_{23}S_5S_6] \\ &\quad + C_1[-S_4C_5S_6 + C_4C_6] \\ o_z &= S_{23}(C_4C_5S_6 + S_4C_6) + C_{23}S_5S_6 \end{aligned} \right\} s = {}^0y_6(q)$$

$$\left. \begin{aligned} a_x &= C_1(C_{23}C_4S_5 + S_{23}C_5) - S_1S_4S_5 \\ a_y &= S_1(C_{23}C_4S_5 + S_{23}C_5) + C_1S_4S_5 \\ a_z &= -S_{23}C_4S_5 + C_{23}C_5 \end{aligned} \right\} a = {}^0z_6(q)$$

$$\left. \begin{aligned} p_x &= C_1(d_4S_{23} + a_3C_{23} + a_2C_2) - S_1d_3 \\ p_y &= S_1(d_4S_{23} + a_3C_{23} + a_2C_2) + C_1d_3 \\ p_z &= -(-d_4C_{23} + a_3S_{23} + a_2S_2) \end{aligned} \right\} p = {}^0_6(q)$$

8 different inverse solutions can be found in closed form [see Paul, Shimano, Mayer; 1981]

a function of q_1, q_2, q_3 only!

slide courtesy Alessandro Roncone

Different solutions

Decisions need to be taken about which configuration to choose...

Wrist position and E-E pose

Inverse solutions for an articulated 6R robot [PUMA 560]

4 inverse solutions
(for the position of the wrist center only)

8 inverse solutions
considering the complete E-E pose (spherical wrist: 2 alternative solutions for the last 3 joints)

How about humanoids?

- For 6 DoF arms, an analytical solution may still exist.
- They don't have spherical wrists.
- But joint axes of first three joints (~ shoulder / hip) do intersect at a point!
- Analytical solution can be found using reverse decoupling.

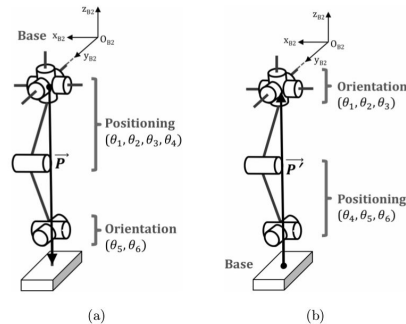

Fig. 5. (a) Forward Decoupling of the Right Leg of a Hubo KHR-4 Robot, (b) Reverse Decoupling of the Right Leg of a Hubo KHR-4 Robot.

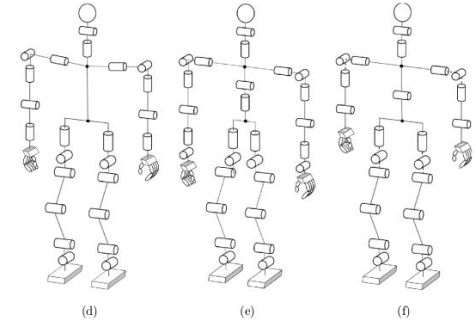
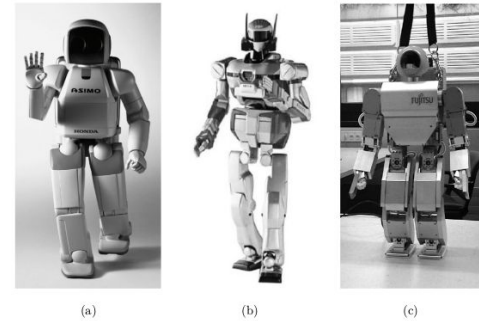
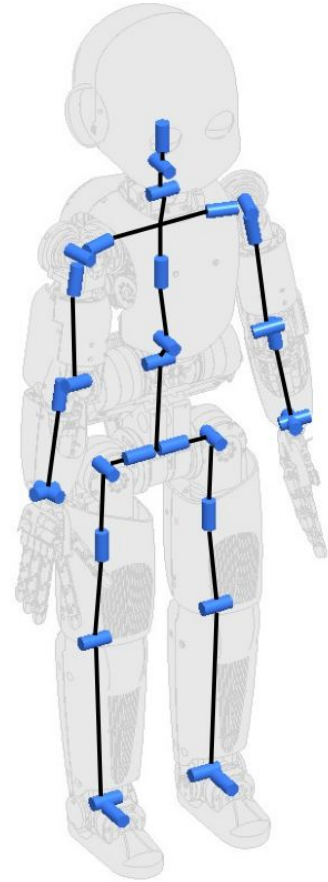

Fig. 4. (a) HONDA ASIMO Robot and its associated kinematic diagram in (d), (b) AIST HRP-2 Robot and its associated kinematic diagram in (e), and (c) Fujitsu HOAP-2 Robot and its associated kinematic diagram in (f).

Park, H. A., Ali, M. A., & Lee, C. G. (2012). Closed-form inverse kinematic position solution for humanoid robots. *International Journal of Humanoid Robotics*, 9(03), 1250022.

How about the iCub?

- The first three shoulder joints also intersect at a point.
- However, there are 7 DoF in the arm!
- Hence, there are infinitely many solutions of the inverse kinematics problem - we will resort to numerical methods.



Take home messages

- Human bodies were not designed to make inverse kinematics & co. easier.
- Humanoid robot bodies are engineered taking a lot of things into account, but they typically cannot afford to have manipulators with spherical wrist and position/orientation decoupling as arms (as it would look weird ;)).
- Traditional designs - rigid materials, rotary joints with electric motors etc. make it possible to apply most of the theory of robot modeling and control.
- There is additional complexity from the fact that there are multiple kinematic chains that cannot be treated in isolation. The robot should, among other things, keep balance (not covered yet)!

Next

- Differential kinematics - Jacobian...
- Inverse differential kinematics
- Singularities
- Manipulability
- Inverse kinematics through optimization
- Gaze control as inverse kinematics

Resources

- Books

- Sections 2.2 and 2.3 in Nenchev, D. N., Konno, A., & Tsujita, T. (2018). *Humanoid robots: Modeling and control*. Butterworth-Heinemann.
- Spong, M. W., Hutchinson, S., & Vidyasagar, M. (2020). *Robot modeling and control*. John Wiley & Sons.
- Corke, P. I. (2013). *Robotics, vision and control: fundamental algorithms in MATLAB* Berlin: Springer.
- Lynch, K. M., & Park, F. C. (2017). *Modern robotics*. Cambridge University Press.

- Articles

- Parmiggiani, A., Maggiali, M., Natale, L., Nori, F., Schmitz, A., Tsagarakis, N., ... & Metta, G. (2012). The design of the iCub humanoid robot. *International journal of humanoid robotics*, 9(04), 1250027.
- Ficht, G., & Behnke, S. (2021). Bipedal humanoid hardware design: A technology review. *Current Robotics Reports*, 2(2), 201-210.