

Problem solving by search

Tomáš Svoboda and Matěj Hoffmann

Vision for Robots and Autonomous Systems, Center for Machine Perception
Department of Cybernetics
Faculty of Electrical Engineering, Czech Technical University in Prague

February 17, 2022

Outline

- ▶ Search problem.
- ▶ State space graphs.
- ▶ Search trees.
- ▶ Strategies: which tree branches to choose?
- ▶ Strategy/Algorithm properties.
- ▶ Programming infrastructure.

Example: Traveling in Romania

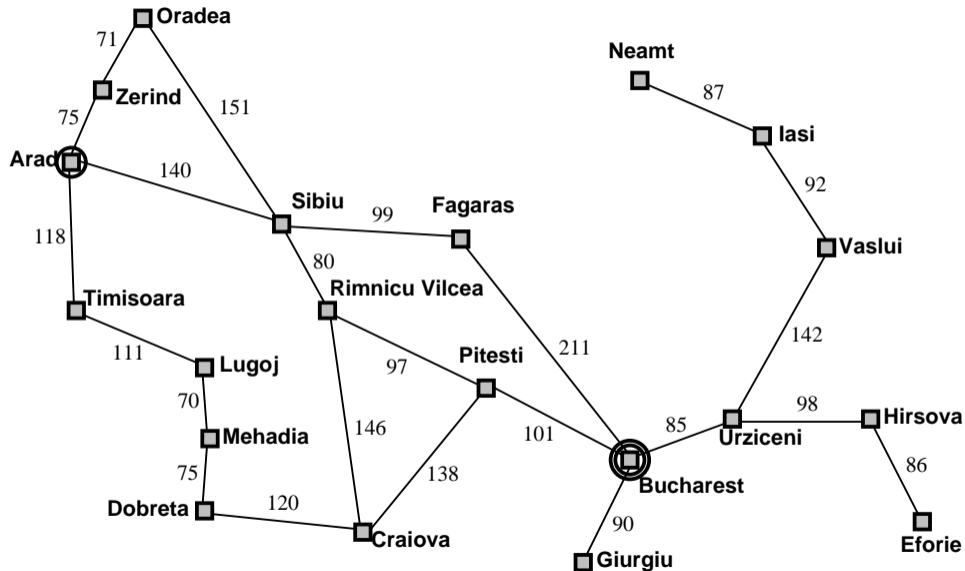

Example: Map of Romania

Goal:

be in Bucharest

Problem formulation:

states: position in a city (cities)

actions: drive between cities

Solution:

Sequence of cities (path)

(action sequence [2])

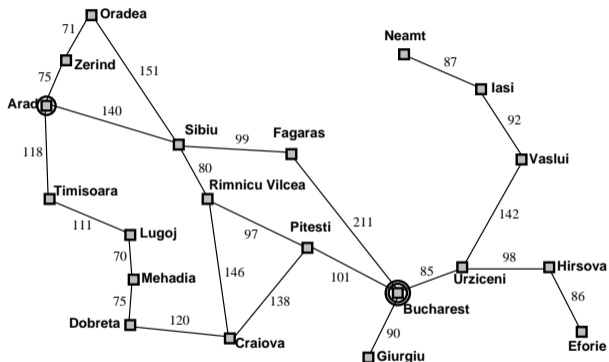

Example: Map of Romania

Goal:

be in Bucharest

Problem formulation:

states: position in a city (cities)

actions: drive between cities

Solution:

Sequence of cities (path)

(action sequence [2])

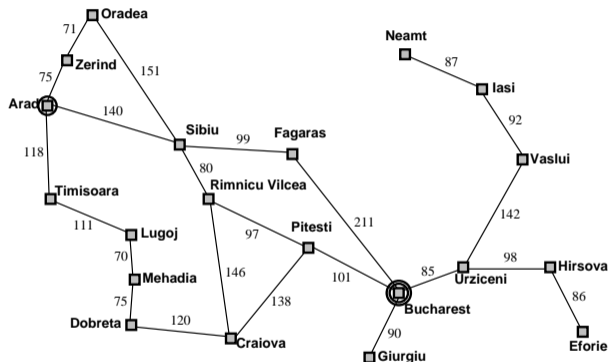

Example: Map of Romania

Goal:

be in Bucharest

Problem formulation:

states: position in a city (cities)

actions: drive between cities

Solution:

Sequence of cities (path)

(action sequence [2])

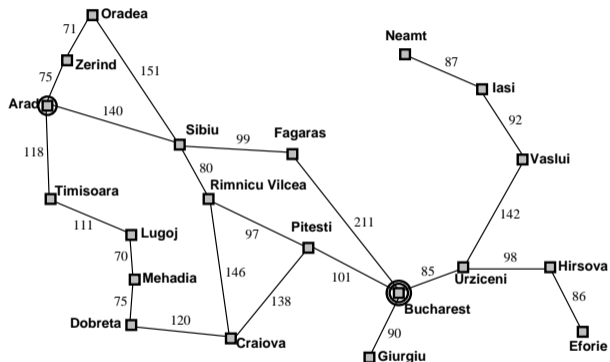

Example: Map of Romania

Goal:

be in Bucharest

Problem formulation:

states: position in a city (cities)

actions: drive between cities

Solution:

Sequence of cities (path)
(action sequence [2])

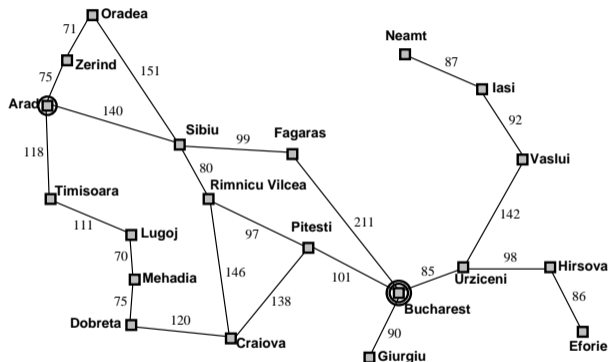

Example: Map of Romania

Goal:

be in Bucharest

Problem formulation:

states: position in a city (cities)

actions: drive between cities

Solution:

Sequence of cities (path)
(action sequence [2])

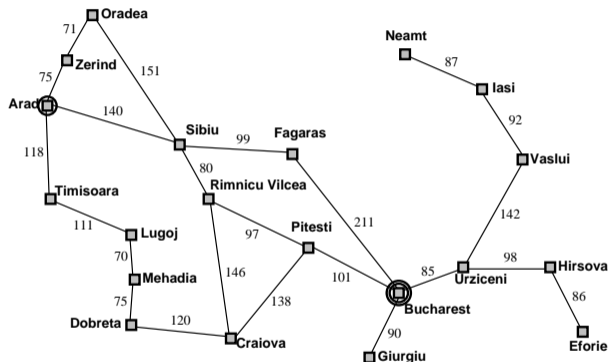

Example: The 8-puzzle

7	2	4
5		6
8	3	1

Start State

1	2	3
4	5	6
7	8	

Goal State

states?
actions?
solution?
cost?

Example: Vacuum cleaner

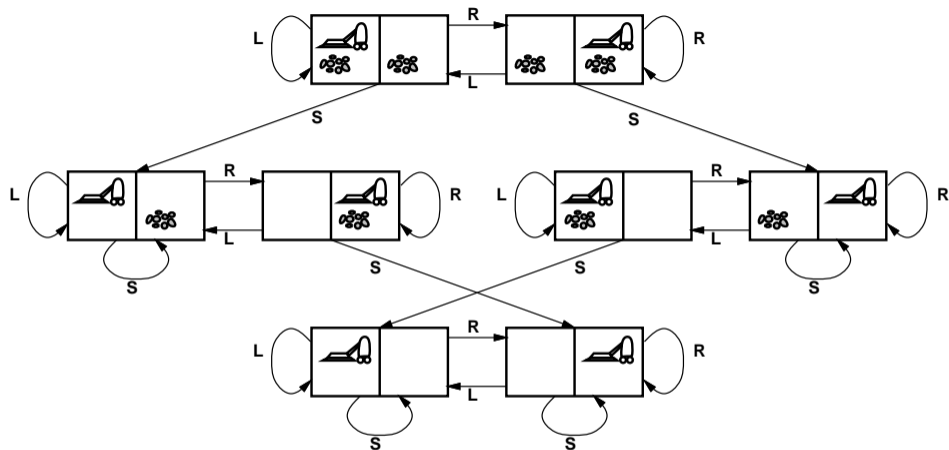

states?
actions?
solution?
cost?

A Search Problem

- ▶ **State space** (including Start/Initial state): position, board configuration,
- ▶ Actions : drive to, Up, Down, Left ...
- ▶ Transition model : Given state and action return state (and cost)
- ▶ Goal test : Are we done?

A Search Problem

- ▶ **State space** (including Start/Initial state): position, board configuration,
- ▶ **Actions** : drive to, Up, Down, Left ...
- ▶ Transition model : Given state and action return state (and cost)
- ▶ Goal test : Are we done?

A Search Problem

- ▶ **State space** (including Start/Initial state): position, board configuration,
- ▶ **Actions** : drive to, Up, Down, Left ...
- ▶ **Transition model** : Given state and action return state (and **cost**)
- ▶ Goal test : Are we done?

A Search Problem

- ▶ **State space** (including Start/Initial state): position, board configuration,
- ▶ **Actions** : drive to, Up, Down, Left ...
- ▶ **Transition model** : Given state and action return state (and **cost**)
- ▶ **Goal test** : Are we done?

State Space Graphs

State space graph: a representation of a search problem

- ▶ Graph Nodes – states – are abstracted world configurations
- ▶ Arcs represent action results
- ▶ Goal test – a set of goal nodes

Each state occurs only *once* in a state (search) space.

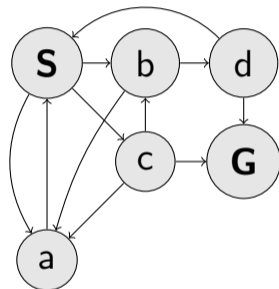

Search Trees

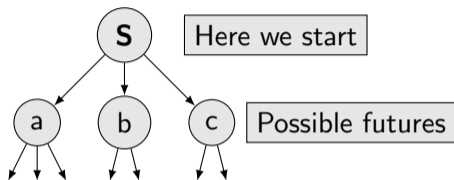

- ▶ A “what if” tree of plans and their outcomes
- ▶ Start node is the root
- ▶ Children are successors
- ▶ Nodes show/contains states, but correspond to *plans* that achieve those states

State Space Graphs vs. Search Trees

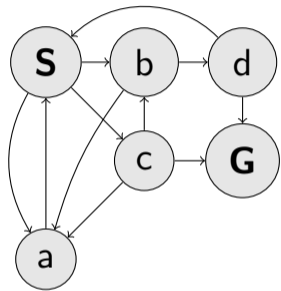

How big is the search tree?

State Space Graphs vs. Search Trees

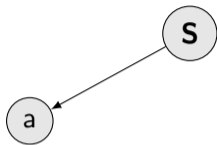
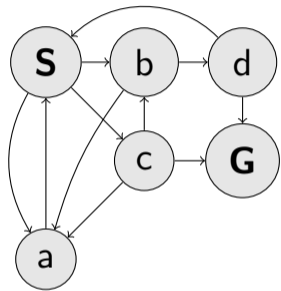

How big is the search tree?

State Space Graphs vs. Search Trees

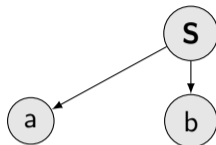
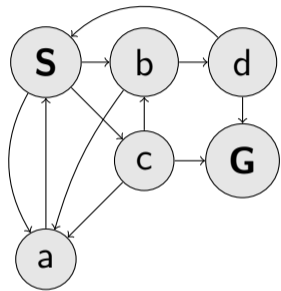

How big is the search tree?

State Space Graphs vs. Search Trees

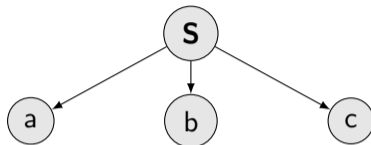
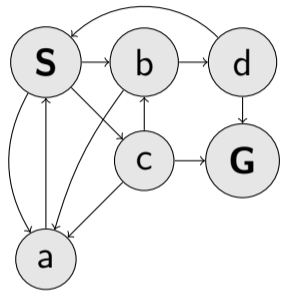

How big is the search tree?

State Space Graphs vs. Search Trees

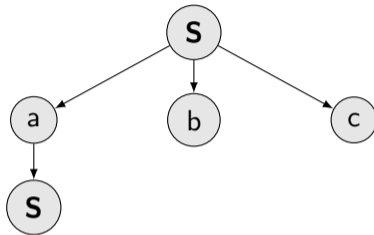
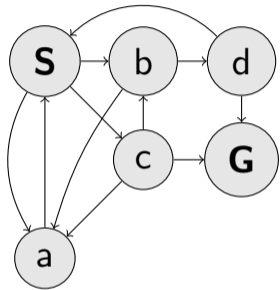

How big is the search tree?

State Space Graphs vs. Search Trees

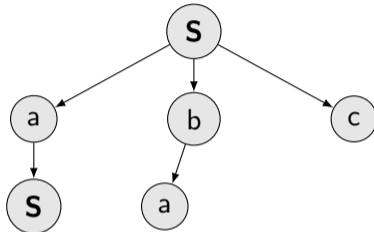
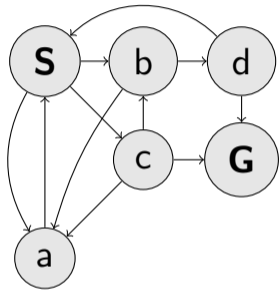

How big is the search tree?

State Space Graphs vs. Search Trees

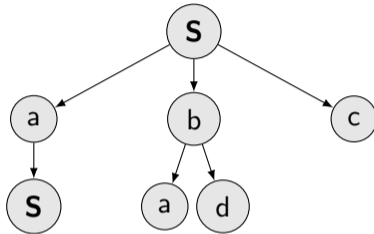
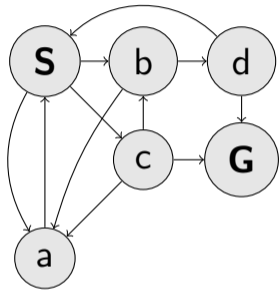

How big is the search tree?

State Space Graphs vs. Search Trees

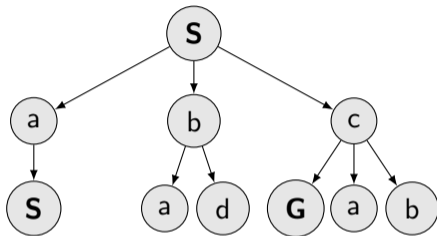
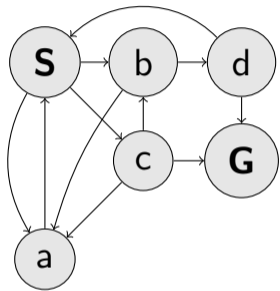

How big is the search tree?

State Space Graphs vs. Search Trees

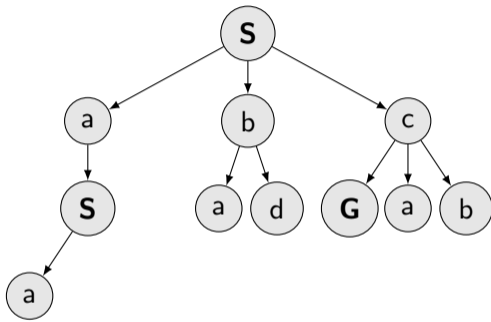
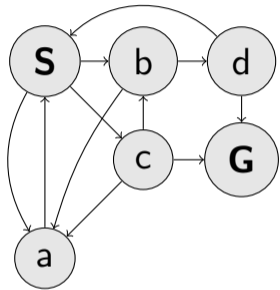

How big is the search tree?

State Space Graphs vs. Search Trees

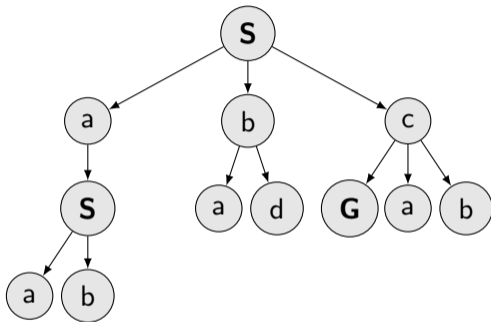
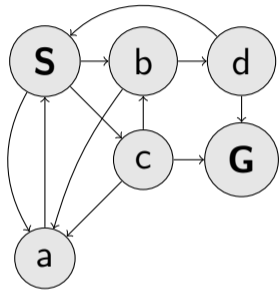

How big is the search tree?

State Space Graphs vs. Search Trees

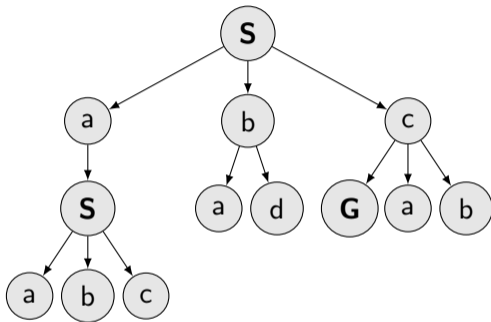
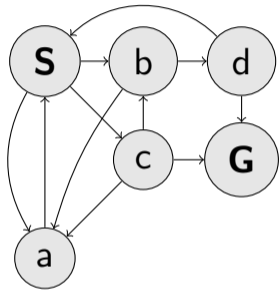

How big is the search tree?

State Space Graphs vs. Search Trees

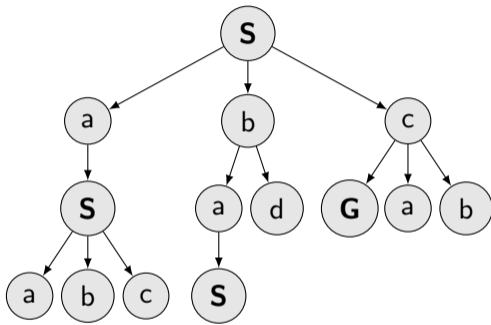
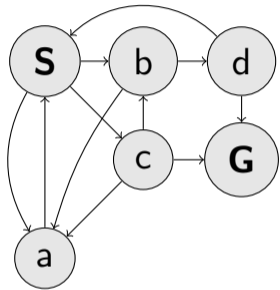

How big is the search tree?

State Space Graphs vs. Search Trees

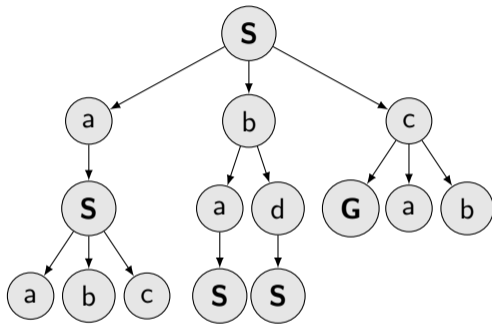
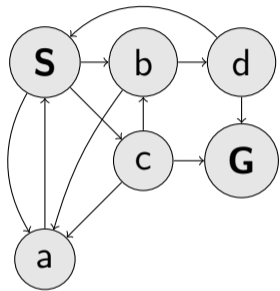

How big is the search tree?

State Space Graphs vs. Search Trees

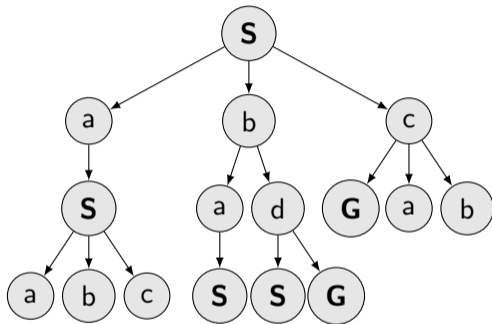
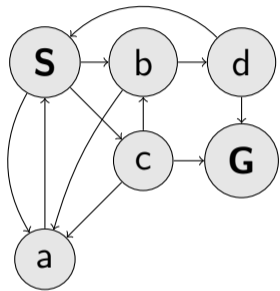

How big is the search tree?

From problem/transition graph to search tree (Romania)

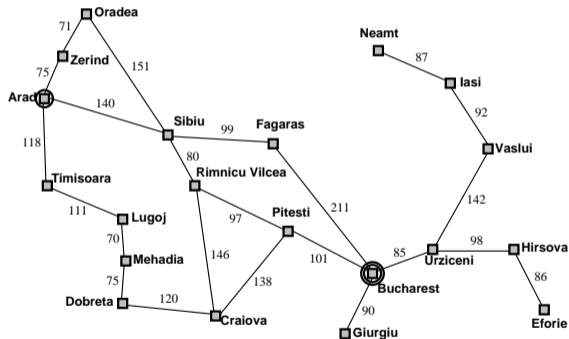

(a) The initial state

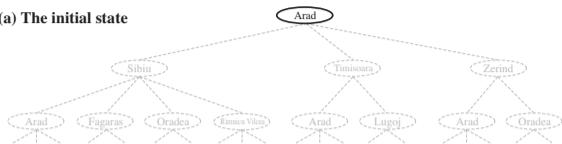

(b) After expanding Arad

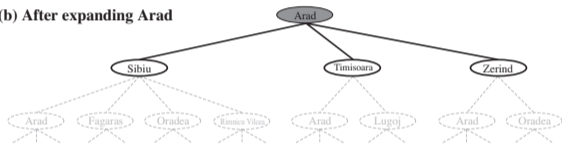

(c) After expanding Sibiu

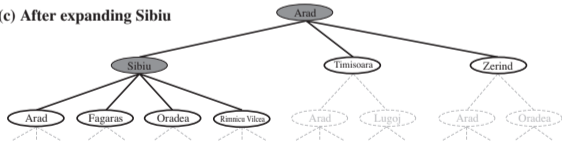

Problem/transition graph is revealed incrementally.

The revealing strategy can be visualized as a search tree.

Search elements - unvisited, dead, alive states

(c) After expanding Sibiu

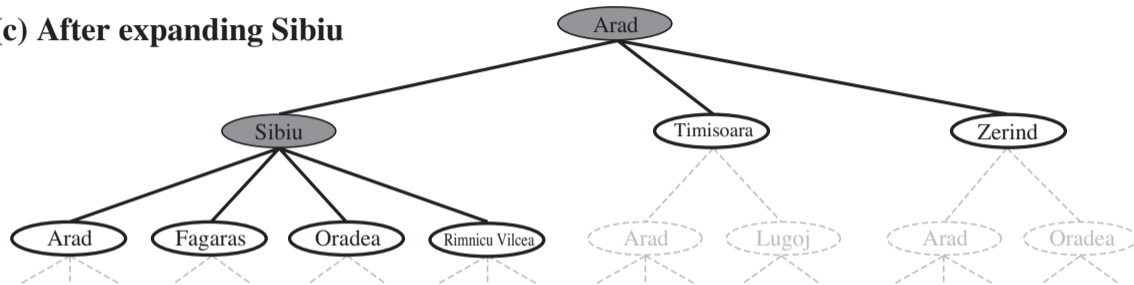

- ▶ Expand **plans** - possible ways (**tree nodes**).
- ▶ Manage/Maintain **fringe** (or **frontier**) of plans under consideration.
- ▶ Expand new nodes *wisely(?)*.

Tree search algorithm

(c) After expanding Sibiu

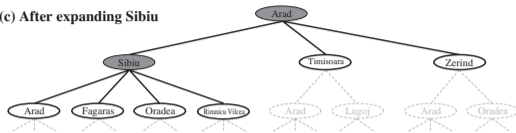

function TREE_SEARCH(problem) **return** a solution or failure

initialize by using the initial state of the problem

loop

if no candidates for expansion **then return** failure

else choose a leaf node for expansion

end if

if the node contains a goal state **then return** the solution

end if

Expand the node and add the resulting nodes to the tree

end loop

end function

Tree search algorithm

(c) After expanding Sibiu

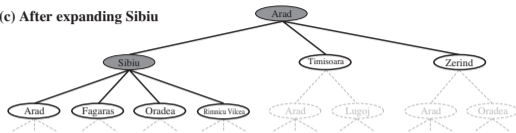

function TREE_SEARCH(problem) **return** a solution or failure
initialize by using the initial state of the problem

loop

if no candidates for expansion **then return** failure

else choose a leaf node for expansion

end if

if the node contains a goal state **then return** the solution

end if

Expand the node and add the resulting nodes to the tree

end loop

end function

Tree search algorithm

(c) After expanding Sibiu

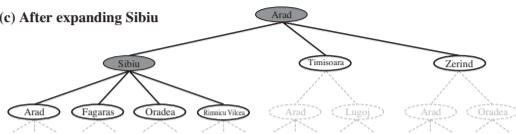

function TREE_SEARCH(problem) **return** a solution or failure

initialize by using the initial state of the problem

loop

if no candidates for expansion **then** return failure

else choose a leaf node for expansion

end if

if the node contains a goal state **then** return the solution

end if

Expand the node and add the resulting nodes to the tree

end loop

end function

Tree search algorithm

(c) After expanding Sibiu

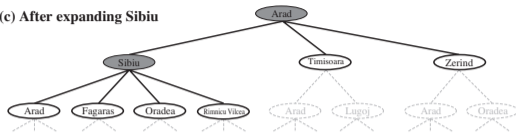

function TREE_SEARCH(problem) **return** a solution or failure

initialize by using the initial state of the problem

loop

if no candidates for expansion **then return** failure

else choose a leaf node for expansion

end if

if the node contains a goal state **then return** the solution

end if

Expand the node and add the resulting nodes to the tree

end loop

end function

Tree search algorithm

(c) After expanding Sibiu

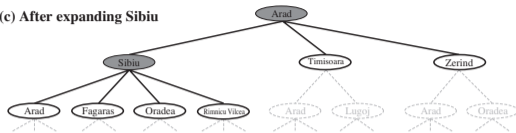

function TREE_SEARCH(problem) **return** a solution or failure

initialize by using the initial state of the problem

loop

if no candidates for expansion **then return** failure

else choose a leaf node for expansion

end if

if the node contains a goal state **then return** the solution

end if

Expand the node and add the resulting nodes to the tree

end loop

end function

Tree search algorithm

(c) After expanding Sibiu

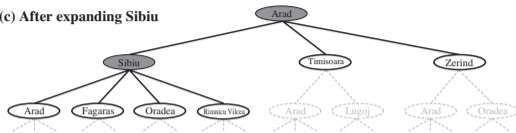

function TREE_SEARCH(problem) **return** a solution or failure

initialize by using the initial state of the problem

loop

if no candidates for expansion **then return** failure

else choose a leaf node for expansion

end if

if the node contains a goal state **then return** the solution

end if

Expand the node and add the resulting nodes to the tree

end loop

end function

Tree search algorithm

(c) After expanding Sibiu



function TREE_SEARCH(problem) **return** a solution or failure

initialize by using the initial state of the problem

loop

if no candidates for expansion **then return** failure

else choose a leaf node for expansion

end if

if the node contains a goal state **then return** the solution

end if

Expand the node and add the resulting nodes to the tree

end loop

end function

Example of a tree search

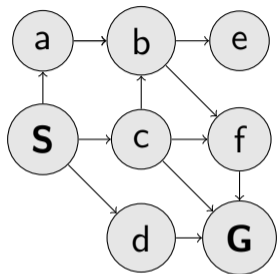

Which nodes to *explore*?

What are the properties of a strategy/algorithm?

Example of a tree search

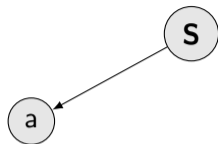
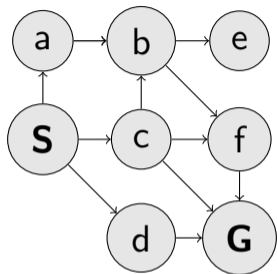

Which nodes to *explore*?

What are the properties of a strategy/algorithm?

Example of a tree search

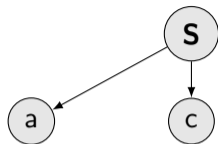
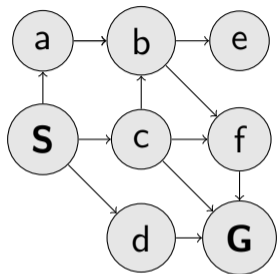

Which nodes to *explore*?

What are the properties of a strategy/algorithm?

Example of a tree search

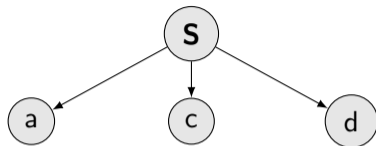
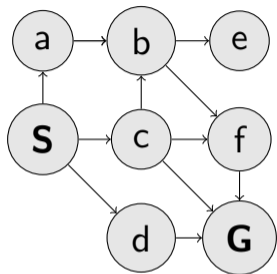

Which nodes to *explore*?

What are the properties of a strategy/algorithm?

Example of a tree search

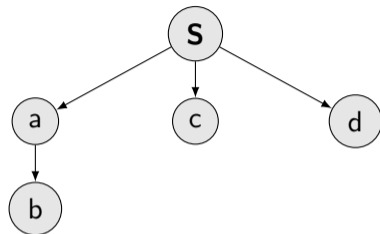
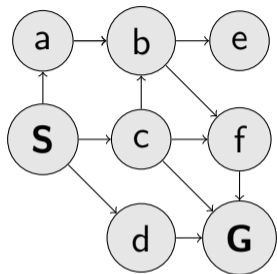

Which nodes to *explore*?

What are the properties of a strategy/algorithm?

Example of a tree search

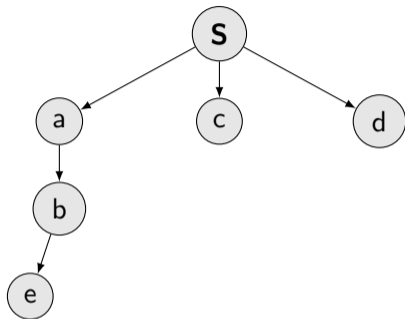
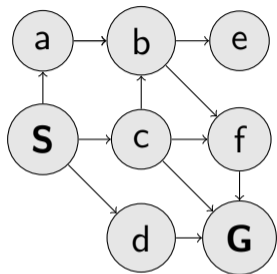

Which nodes to *explore*?

What are the properties of a strategy/algorithm?

Example of a tree search

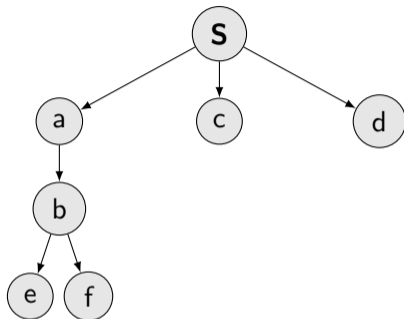
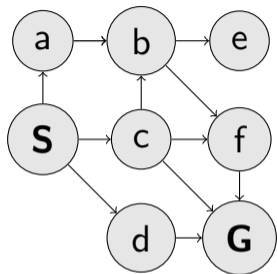

Which nodes to *explore*?

What are the properties of a strategy/algorithm?

Example of a tree search

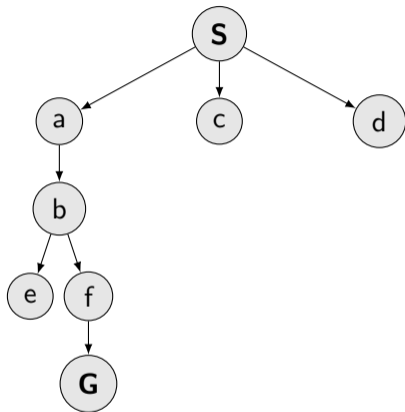
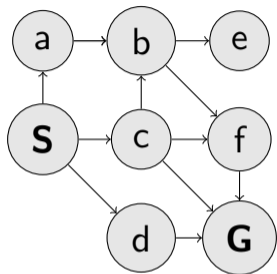

Which nodes to *explore*?

What are the properties of a strategy/algorithm?

Example of a tree search

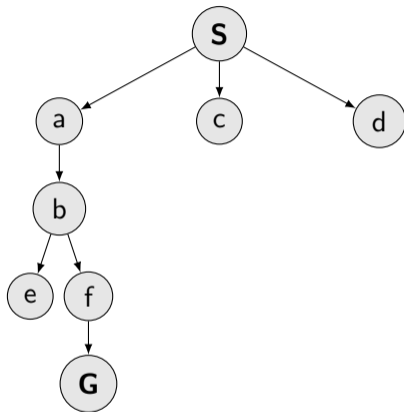
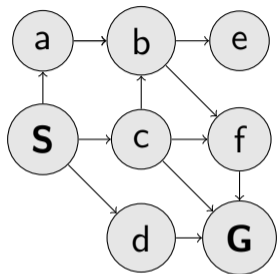

Which nodes to *explore*?

What are the properties of a strategy/algorithm?

Example of a tree search

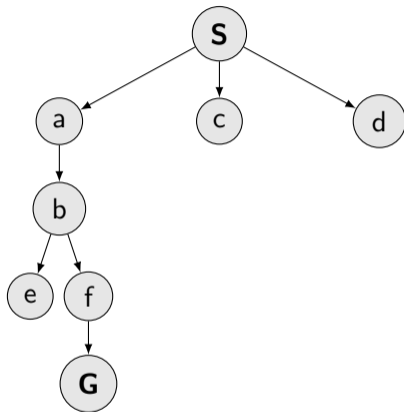
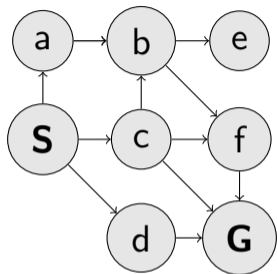

Which nodes to *explore*?

What are the properties of a strategy/algorithm?

Search (algorithm) properties

- ▶ Guaranteed to find a solution (if exists)? Complete?
- ▶ Guaranteed to find the least cost path? Optimal?
- ▶ How many steps - an operation with a node? Time complexity?
- ▶ How many nodes to remember? Space/Memory complexity?

How many nodes in a (search) tree? What are tree parameters?

Search (algorithm) properties

- ▶ Guaranteed to find a solution (if exists)? **Complete?**
- ▶ Guaranteed to find the least cost path? **Optimal?**
- ▶ How many steps - an operation with a node? **Time complexity?**
- ▶ How many nodes to remember? **Space/Memory complexity?**

How many nodes in a (search) tree? What are tree parameters?

Search (algorithm) properties

- ▶ Guaranteed to find a solution (if exists)? **Complete?**
- ▶ Guaranteed to find the least cost path? **Optimal?**
- ▶ How many steps - an operation with a node? **Time complexity?**
- ▶ How many nodes to remember? **Space/Memory complexity?**

How many nodes in a (search) tree? What are tree parameters?

Search (algorithm) properties

- ▶ Guaranteed to find a solution (if exists)? **Complete?**
- ▶ Guaranteed to find the least cost path? **Optimal?**
- ▶ How many steps - an operation with a node? Time complexity?
- ▶ How many nodes to remember? Space/Memory complexity?

How many nodes in a (search) tree? What are tree parameters?

Search (algorithm) properties

- ▶ Guaranteed to find a solution (if exists)? **Complete?**
- ▶ Guaranteed to find the least cost path? **Optimal?**
- ▶ How many steps - an operation with a node? Time complexity?
- ▶ How many nodes to remember? Space/Memory complexity?

How many nodes in a (search) tree? What are tree parameters?

Search (algorithm) properties

- ▶ Guaranteed to find a solution (if exists)? **Complete?**
- ▶ Guaranteed to find the least cost path? **Optimal?**
- ▶ How many steps - an operation with a node? **Time** complexity?
- ▶ How many nodes to remember? **Space/Memory** complexity?

How many nodes in a (search) tree? What are tree parameters?

Search (algorithm) properties

- ▶ Guaranteed to find a solution (if exists)? **Complete?**
- ▶ Guaranteed to find the least cost path? **Optimal?**
- ▶ How many steps - an operation with a node? **Time** complexity?
- ▶ How many nodes to remember? **Space/Memory** complexity?

How many nodes in a (search) tree? What are tree parameters?

Search (algorithm) properties

- ▶ Guaranteed to find a solution (if exists)? **Complete?**
- ▶ Guaranteed to find the least cost path? **Optimal?**
- ▶ How many steps - an operation with a node? **Time** complexity?
- ▶ How many nodes to remember? **Space/Memory** complexity?

How many nodes in a (search) tree? What are tree parameters?

Search (algorithm) properties

- ▶ Guaranteed to find a solution (if exists)? **Complete?**
- ▶ Guaranteed to find the least cost path? **Optimal?**
- ▶ How many steps - an operation with a node? **Time** complexity?
- ▶ How many nodes to remember? **Space/Memory** complexity?

How many nodes in a (search) tree? **What are tree parameters?**

Search (algorithm) properties

- ▶ Guaranteed to find a solution (if exists)? **Complete?**
- ▶ Guaranteed to find the least cost path? **Optimal?**
- ▶ How many steps - an operation with a node? **Time** complexity?
- ▶ How many nodes to remember? **Space/Memory** complexity?

How many nodes in a (search) tree? What are tree parameters?

Strategies

How to traverse/build a search tree?

- ▶ **Depth** of the tree d .
- ▶ **Max-Depth** of the tree m . Can be ∞ .
- ▶ **Branching** factor b .
- ▶ s denotes the **shallowest Goal**.
- ▶ How many nodes in the whole tree?

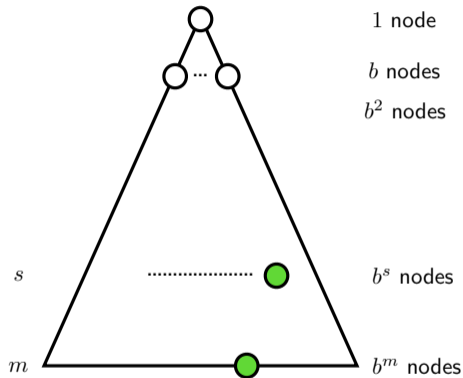

Depth-First Search (DFS)

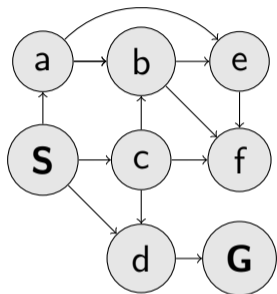

What are the DFS properties (complete, optimal, time, space)?

Depth-First Search (DFS)

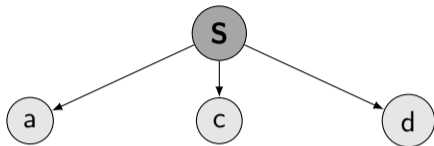
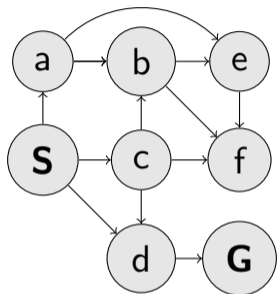

What are the DFS properties (complete, optimal, time, space)?

Depth-First Search (DFS)

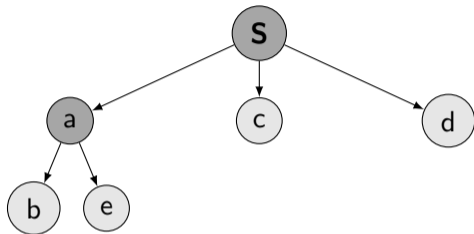
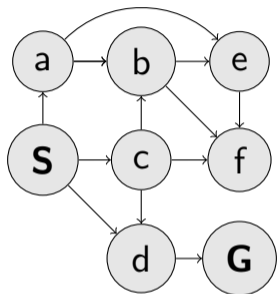

What are the DFS properties (complete, optimal, time, space)?

Depth-First Search (DFS)

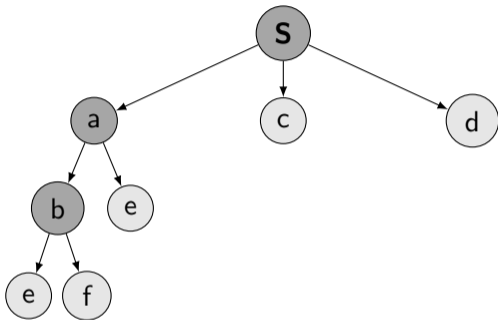
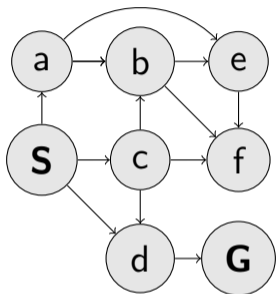

What are the DFS properties (complete, optimal, time, space)?

Depth-First Search (DFS)

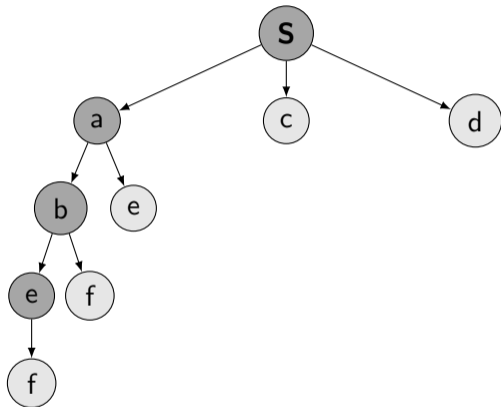
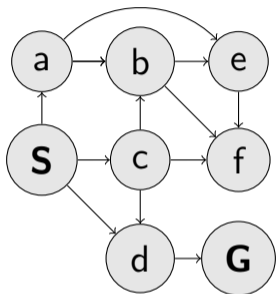

What are the DFS properties (complete, optimal, time, space)?

Depth-First Search (DFS)

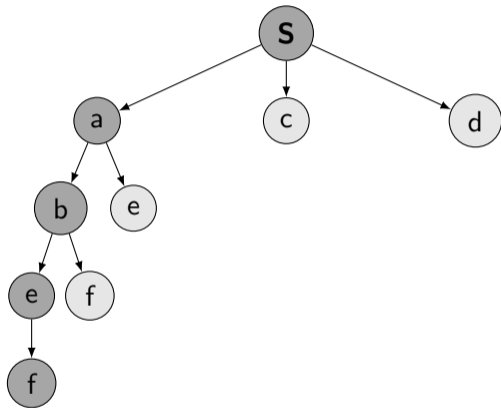
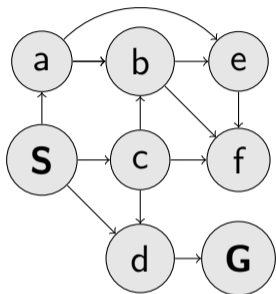

What are the DFS properties (complete, optimal, time, space)?

Depth-First Search (DFS)

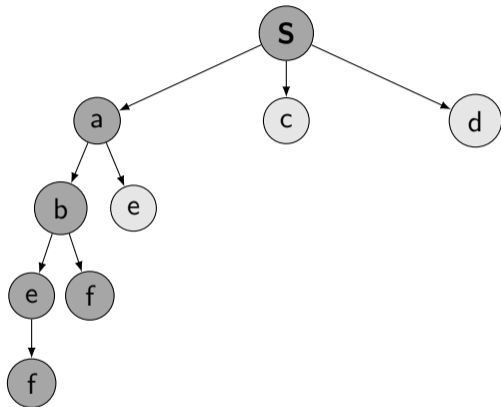
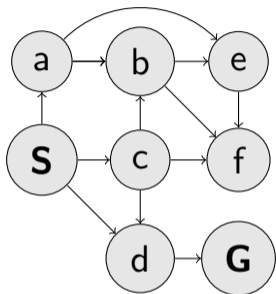

What are the DFS properties (complete, optimal, time, space)?

Depth-First Search (DFS)

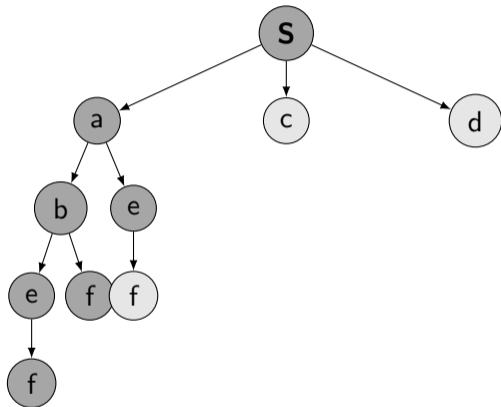
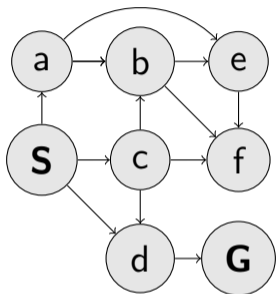

What are the DFS properties (complete, optimal, time, space)?

Depth-First Search (DFS)

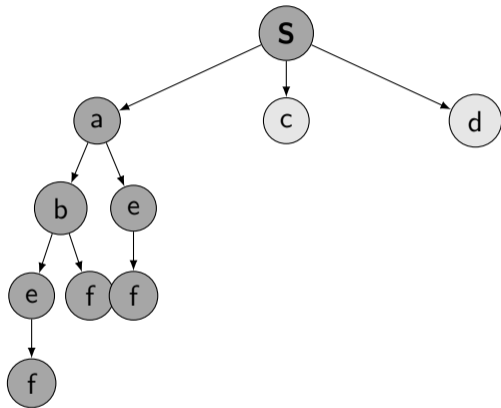
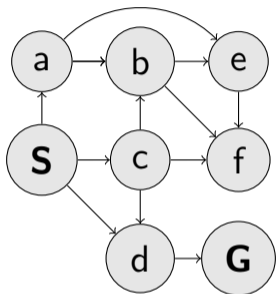

What are the DFS properties (complete, optimal, time, space)?

Depth-First Search (DFS)

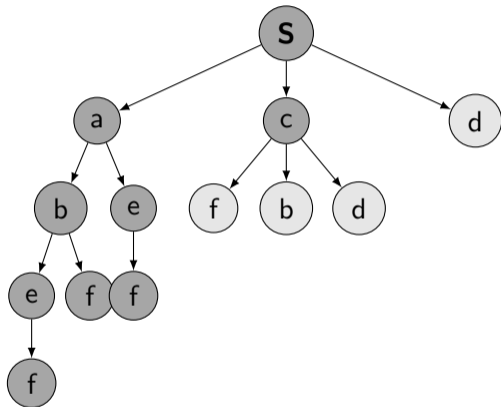
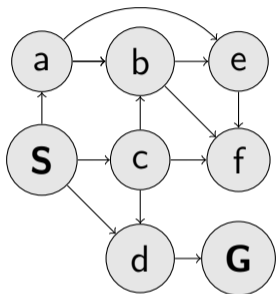

What are the DFS properties (complete, optimal, time, space)?

Depth-First Search (DFS)

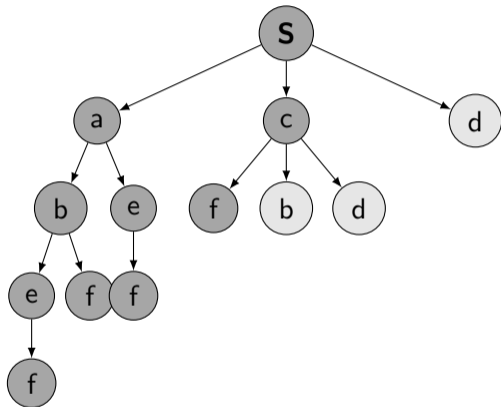
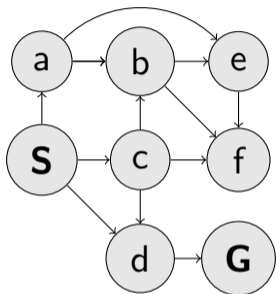

What are the DFS properties (complete, optimal, time, space)?

Depth-First Search (DFS)

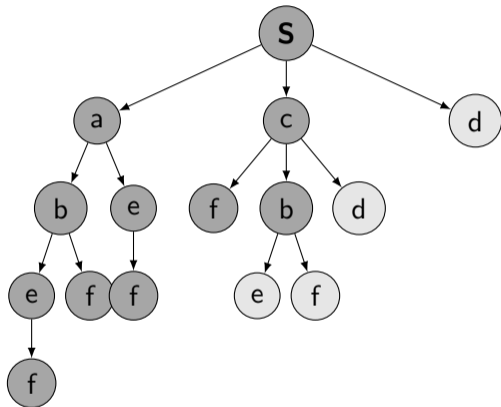
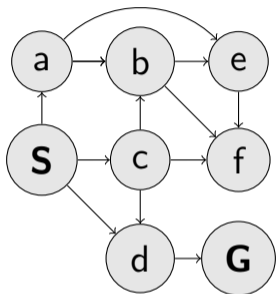

What are the DFS properties (complete, optimal, time, space)?

Depth-First Search (DFS)

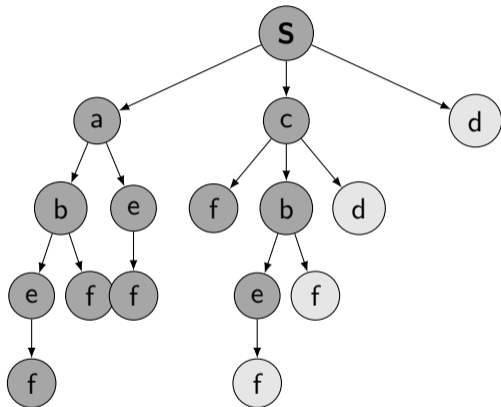
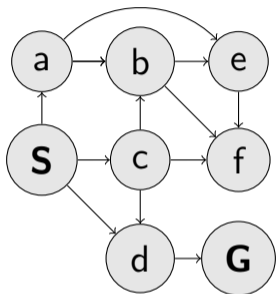

What are the DFS properties (complete, optimal, time, space)?

Depth-First Search (DFS)

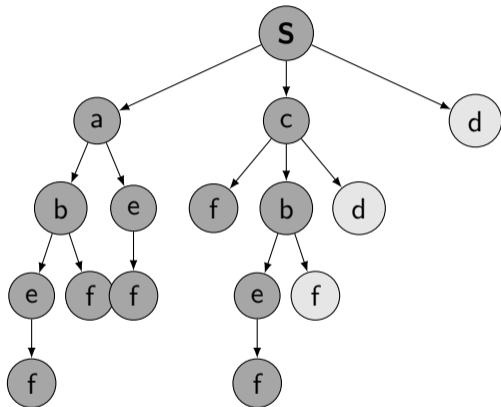
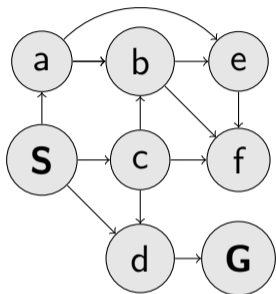

What are the DFS properties (complete, optimal, time, space)?

Depth-First Search (DFS)

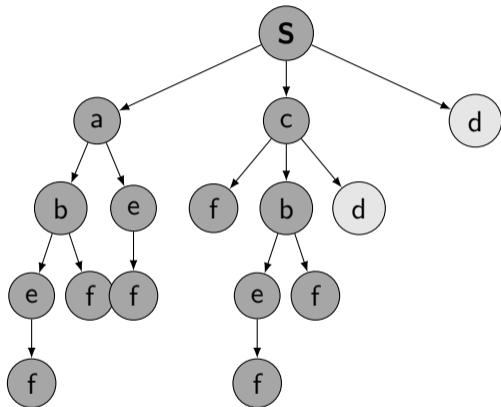
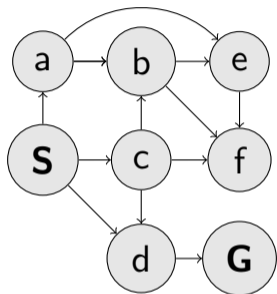

What are the DFS properties (complete, optimal, time, space)?

Depth-First Search (DFS)

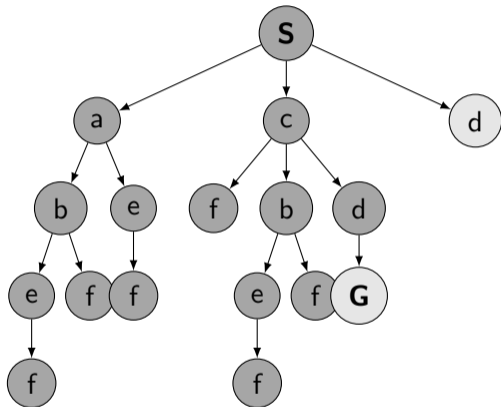
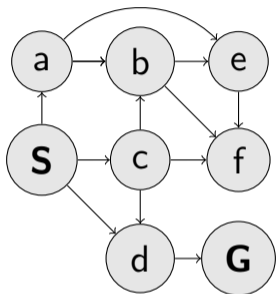

What are the DFS properties (complete, optimal, time, space)?

DFS properties

- ▶ Time complexity?
- ▶ Space complexity?
- ▶ Complete?
- ▶ Optimal?

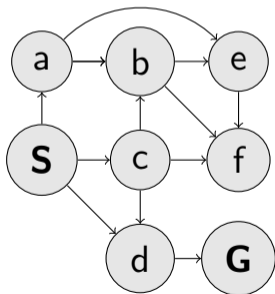

b, m, s , Time complexity?

A $\mathcal{O}(bm)$

B $\mathcal{O}(b^m)$

C $\mathcal{O}(m^b)$

D ∞

DFS properties

- ▶ Time complexity?
- ▶ Space complexity?
- ▶ Complete?
- ▶ Optimal?

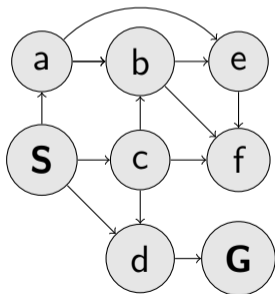

b, m, s , Space complexity?

A $\mathcal{O}(bm)$

B $\mathcal{O}(b^m)$

C $\mathcal{O}(m^b)$

D ∞

Breadth-First Search (BFS)

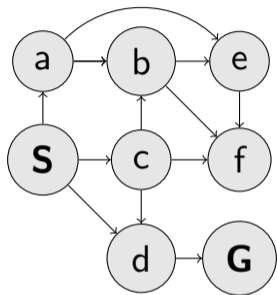

What are the BFS properties?

Breadth-First Search (BFS)

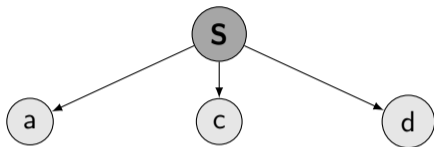
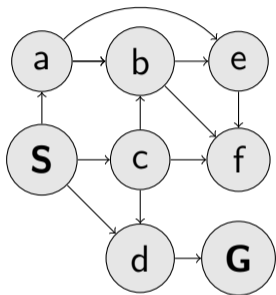

What are the BFS properties?

Breadth-First Search (BFS)

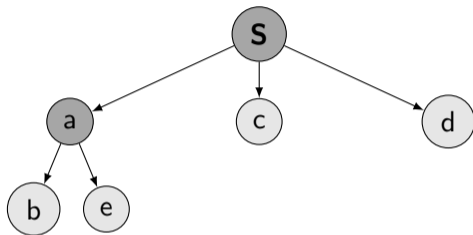
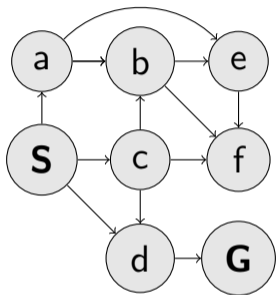

What are the BFS properties?

Breadth-First Search (BFS)

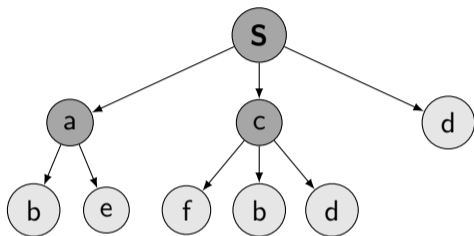
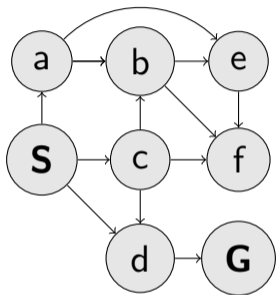

What are the BFS properties?

Breadth-First Search (BFS)

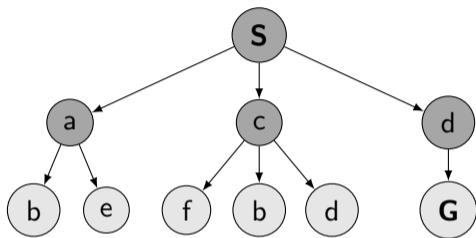
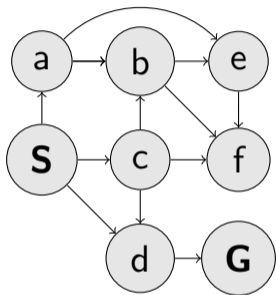

What are the BFS properties?

Breadth-First Search (BFS)

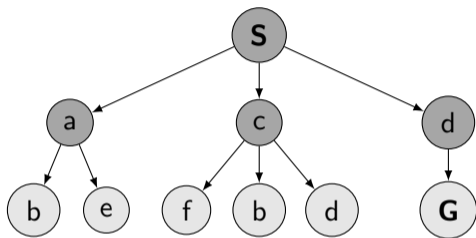
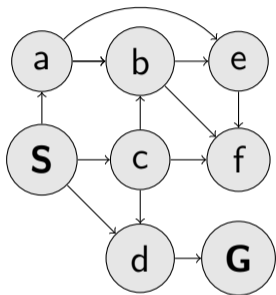

What are the BFS properties?

BFS properties

- ▶ Time complexity?
- ▶ Space complexity?
- ▶ Complete?
- ▶ Optimal?

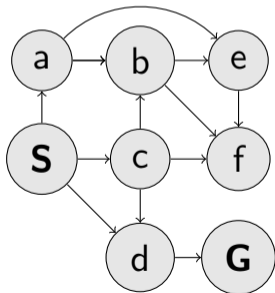

b, m, s , Time complexity?

A $\mathcal{O}(bm)$

B $\mathcal{O}(b^m)$

C $\mathcal{O}(m^b)$

D ∞

E $\mathcal{O}(b^s)$

BFS properties

- ▶ Time complexity?
- ▶ Space complexity?
- ▶ Complete?
- ▶ Optimal?

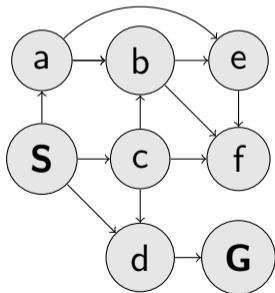

b, m, s , Space complexity?

A $\mathcal{O}(bm)$

B $\mathcal{O}(b^m)$

C $\mathcal{O}(m^b)$

D ∞

E $\mathcal{O}(b^s)$

DFS vs BFS

What are (dis)advantages of the individual strategies?



DFS vs BFS

What are (dis)advantages of the individual strategies?

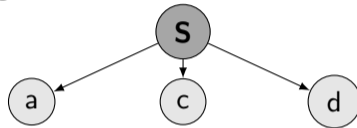
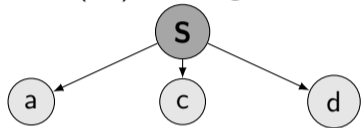

DFS vs BFS

What are (dis)advantages of the individual strategies?

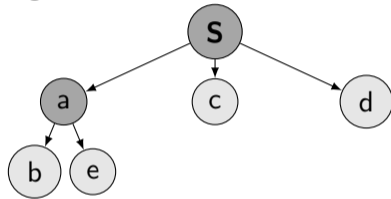
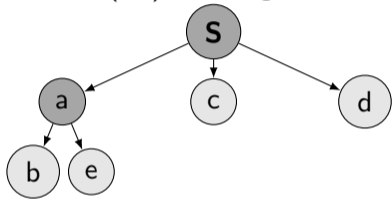

DFS vs BFS

What are (dis)advantages of the individual strategies?

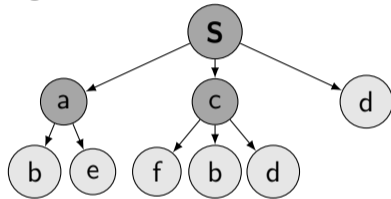
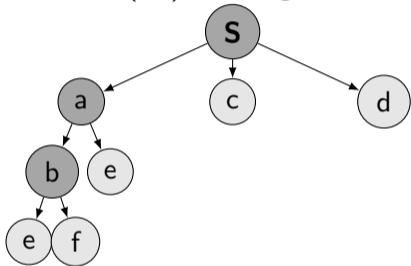

DFS vs BFS

What are (dis)advantages of the individual strategies?

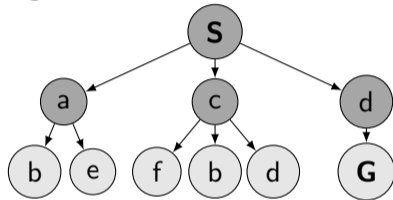
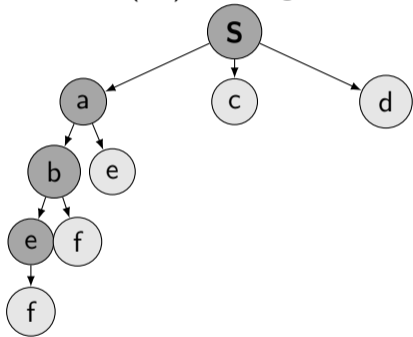

DFS vs BFS

What are (dis)advantages of the individual strategies?

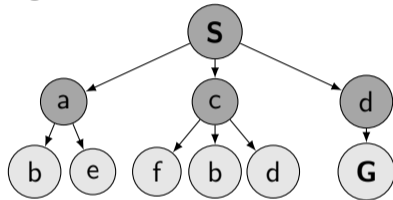
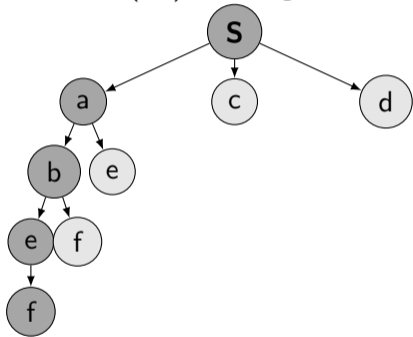

DFS vs BFS

What are (dis)advantages of the individual strategies?

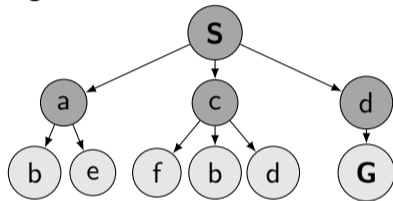
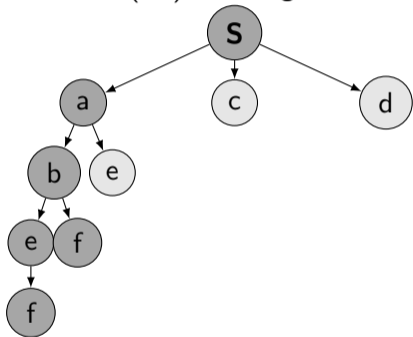

DFS vs BFS

What are (dis)advantages of the individual strategies?

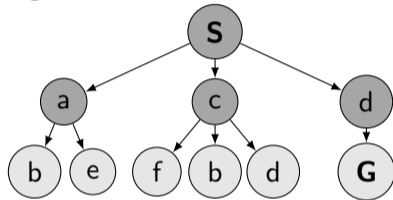
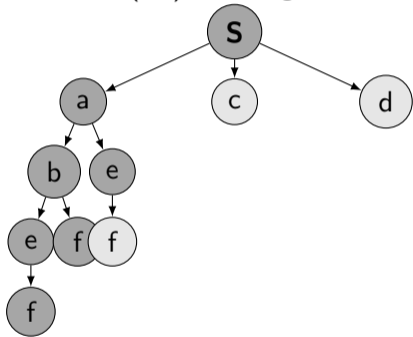

DFS vs BFS

What are (dis)advantages of the individual strategies?

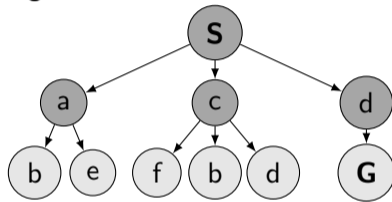
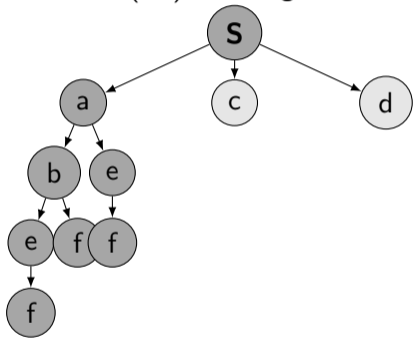

DFS vs BFS

What are (dis)advantages of the individual strategies?

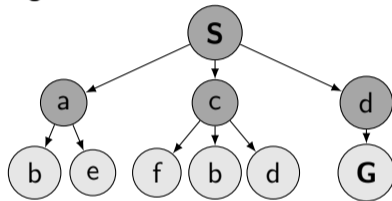
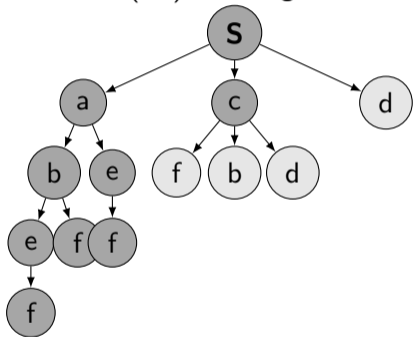

DFS vs BFS

What are (dis)advantages of the individual strategies?

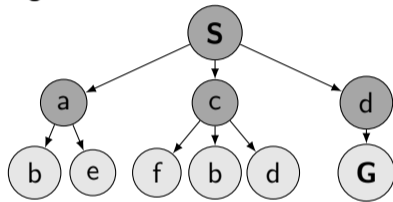
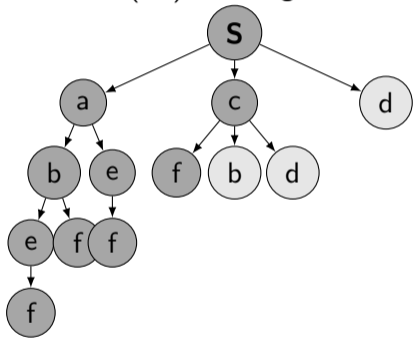

DFS vs BFS

What are (dis)advantages of the individual strategies?

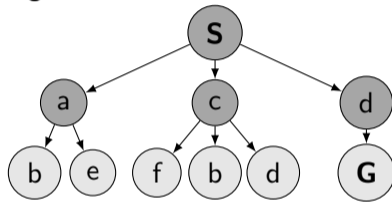
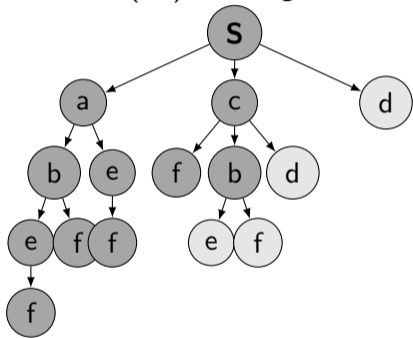

DFS vs BFS

What are (dis)advantages of the individual strategies?

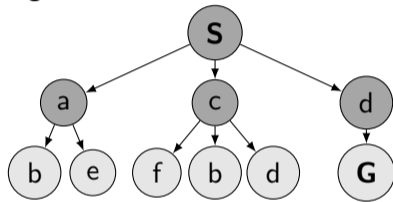
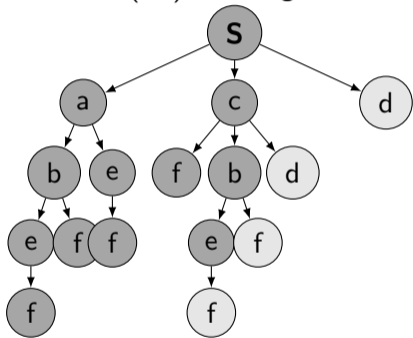

DFS vs BFS

What are (dis)advantages of the individual strategies?

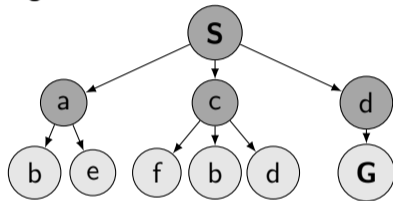
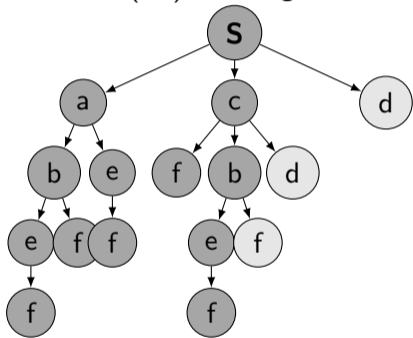

DFS vs BFS

What are (dis)advantages of the individual strategies?

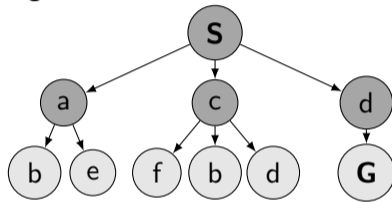
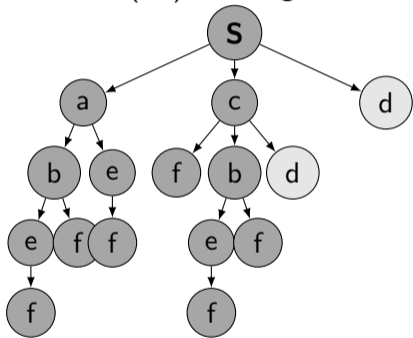

DFS vs BFS

What are (dis)advantages of the individual strategies?

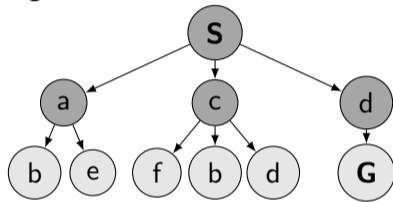
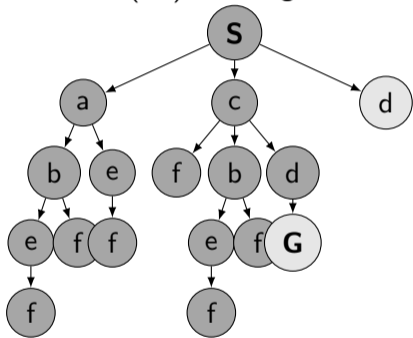

DFS with limited depth, maxdepth=2

Do not follow nodes with depth $>$ maxdepth

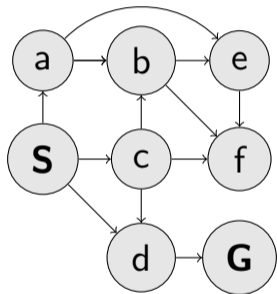

DFS with limited depth, maxdepth=2

Do not follow nodes with depth > maxdepth

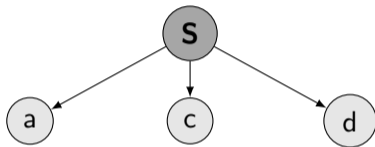
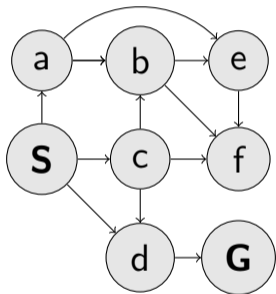

DFS with limited depth, maxdepth=2

Do not follow nodes with depth > maxdepth

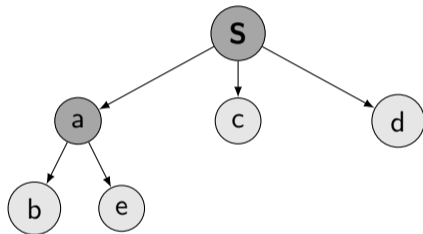
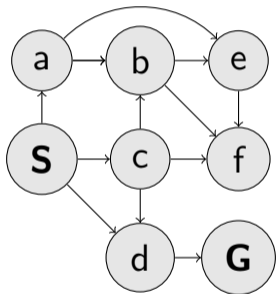

DFS with limited depth, maxdepth=2

Do not follow nodes with depth > maxdepth

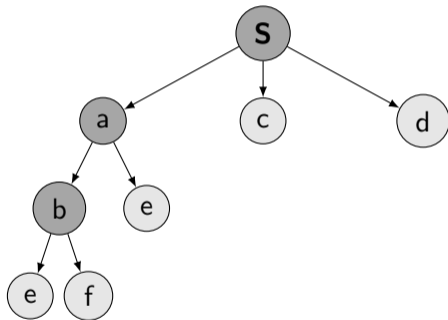
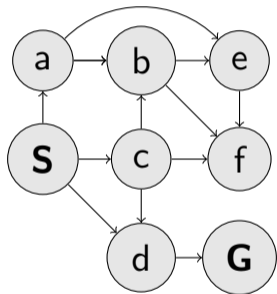

DFS with limited depth, maxdepth=2

Do not follow nodes with depth > maxdepth

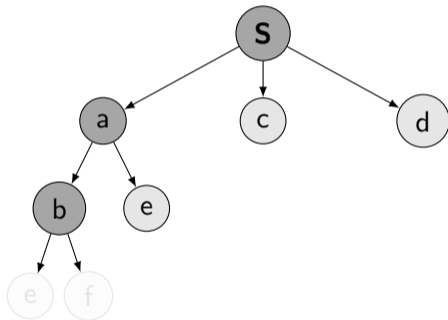
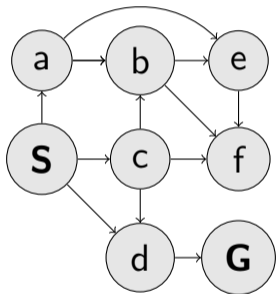

DFS with limited depth, maxdepth=2

Do not follow nodes with depth > maxdepth

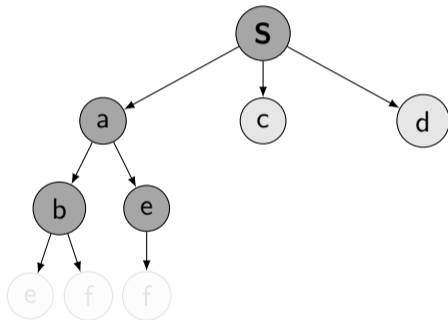
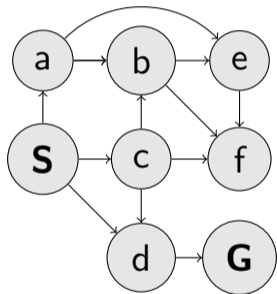

DFS with limited depth, maxdepth=2

Do not follow nodes with depth > maxdepth

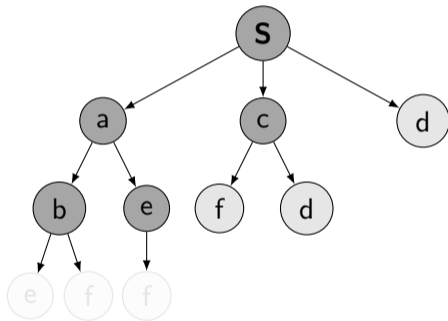
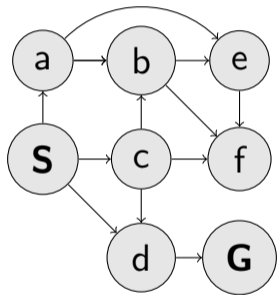

DFS with limited depth, maxdepth=2

Do not follow nodes with depth > maxdepth

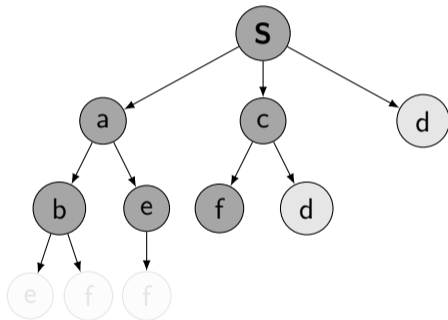
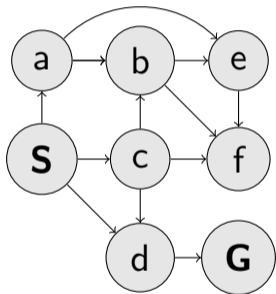

DFS with limited depth, maxdepth=2

Do not follow nodes with depth $>$ maxdepth

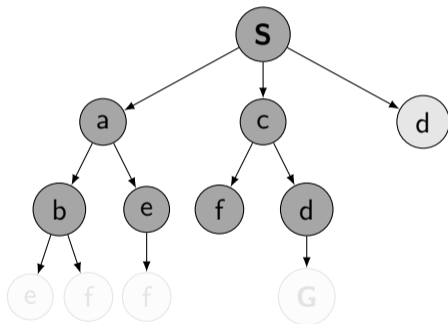
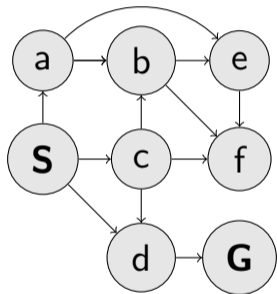

DFS with limited depth, maxdepth=2

Do not follow nodes with depth > maxdepth

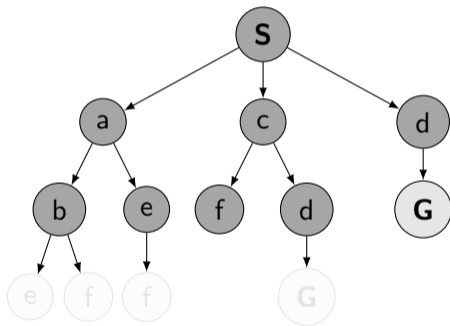
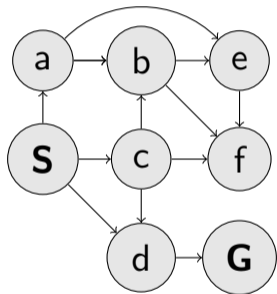

Iterative deepening DFS (ID-DFS)

- ▶ Start with `maxdepth = 1`
 - ▶ Perform DFS with limited depth. Report success or failure.
 - ▶ If failure, forget everything, increase `maxdepth` and repeat DFS

Is it not a terrible waste to forget everything between steps?

Iterative deepening DFS (ID-DFS)

- ▶ Start with `maxdepth = 1`
- ▶ Perform DFS with limited depth. Report success or failure.
 - ▶ If failure, forget everything, increase `maxdepth` and repeat DFS

Is it not a terrible waste to forget everything between steps?

Iterative deepening DFS (ID-DFS)

- ▶ Start with `maxdepth = 1`
- ▶ Perform DFS with limited depth. Report success or failure.
- ▶ If failure, forget everything, increase `maxdepth` and repeat DFS

Is it not a terrible waste to forget everything between steps?

Iterative deepening DFS (ID-DFS)

- ▶ Start with `maxdepth = 1`
- ▶ Perform DFS with limited depth. Report success or failure.
- ▶ If failure, forget everything, increase `maxdepth` and repeat DFS

Is it not a terrible waste to forget everything between steps?

Cost sensitive search

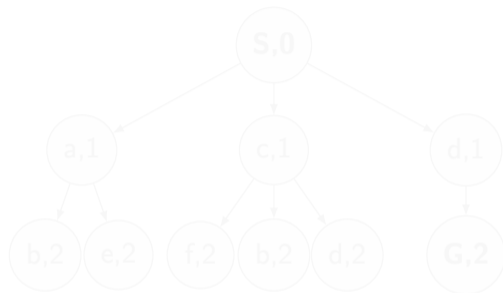
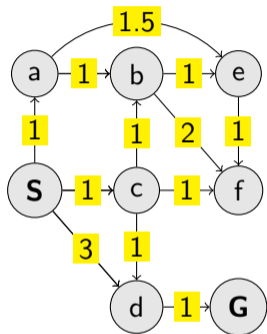

- ▶ In BFS, DFS, node \pm depth was the node-value.
- ▶ How was the depth actually computed?
- ▶ How to evaluate nodes with path cost?

Cost sensitive search

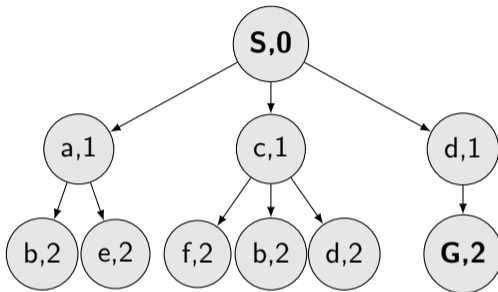
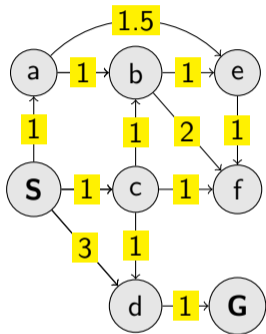

- ▶ In BFS, DFS, node \pm depth was the node-value.
- ▶ How was the depth actually computed?
- ▶ How to evaluate nodes with path cost?

Cost sensitive search

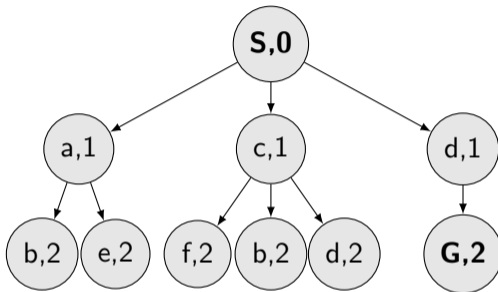
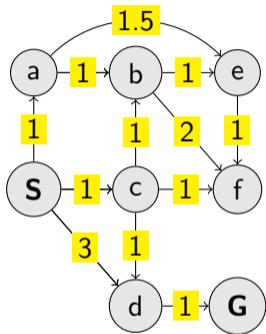

- ▶ In BFS, DFS, node \pm depth was the node-value.
- ▶ How was the depth actually computed?
- ▶ How to evaluate nodes with path cost?

Cost sensitive search

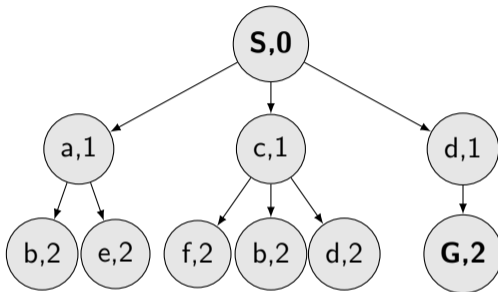
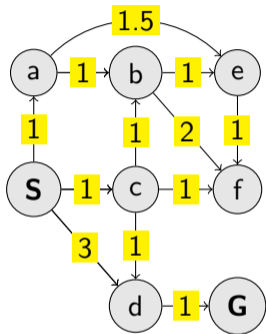

- ▶ In BFS, DFS, node \pm depth was the node-value.
- ▶ How was the depth actually computed?
- ▶ How to evaluate nodes with path cost?

Uniform Cost Search (UCS)

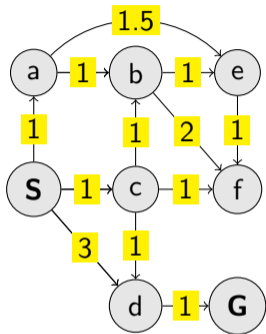

When to check the goal (and stop) the search? When visiting or expanding the node?

Uniform Cost Search (UCS)

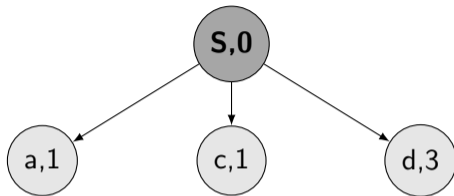
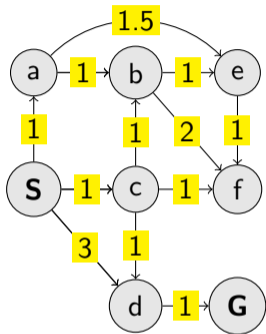

When to check the goal (and stop) the search? When visiting or expanding the node?

Uniform Cost Search (UCS)

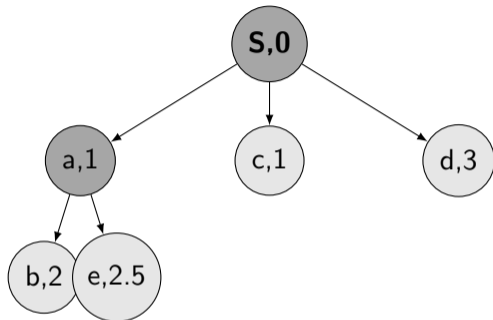
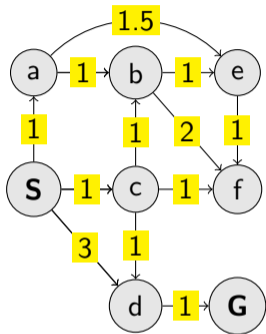

When to check the goal (and stop) the search? When visiting or expanding the node?

Uniform Cost Search (UCS)

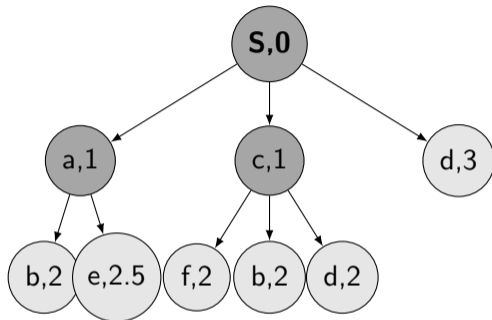
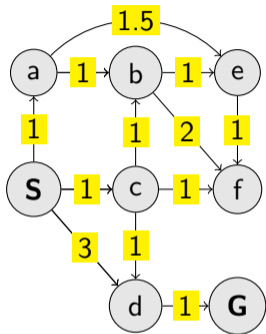

When to check the goal (and stop) the search? When visiting or expanding the node?

Uniform Cost Search (UCS)

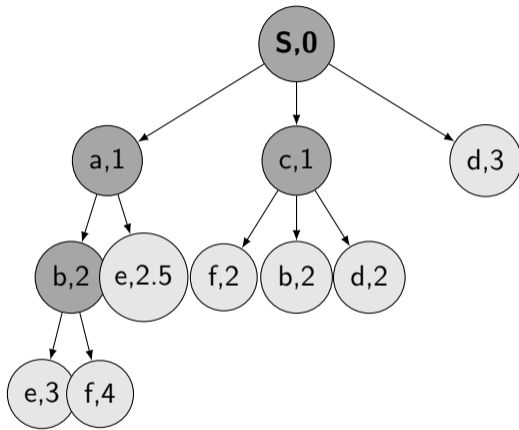
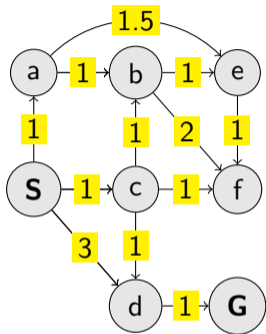

When to check the goal (and stop) the search? When visiting or expanding the node?

Uniform Cost Search (UCS)

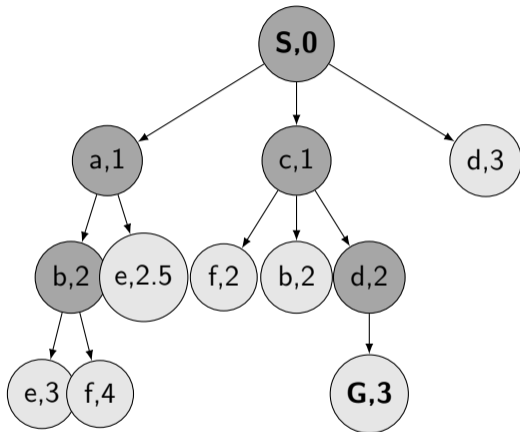
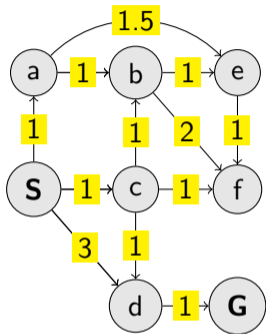

When to check the goal (and stop) the search? When visiting or expanding the node?

Uniform Cost Search (UCS)

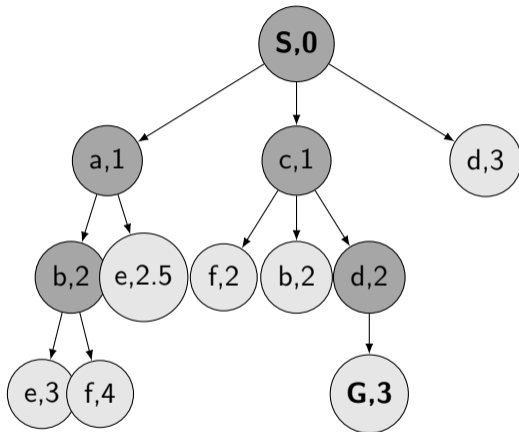
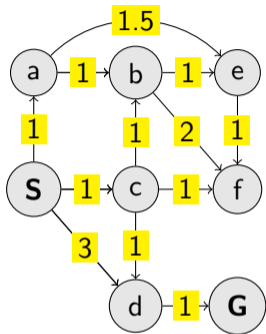

When to **check the goal** (and stop) the search? When visiting or expanding the node?

When to stop, when visiting or expanding?

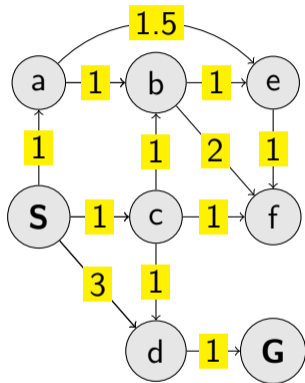

When to stop, when visiting or expanding?

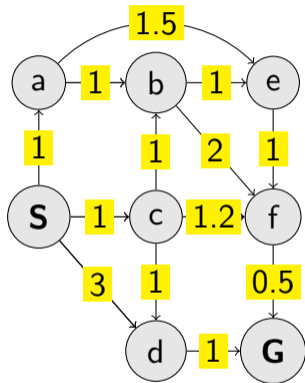

When to stop, when visiting or expanding?

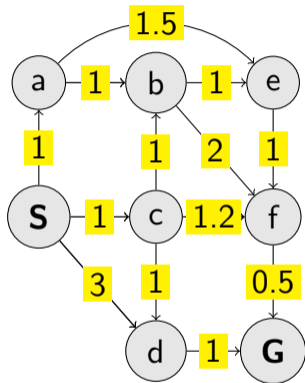

When to stop, when visiting or expanding?

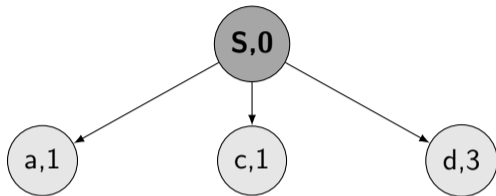
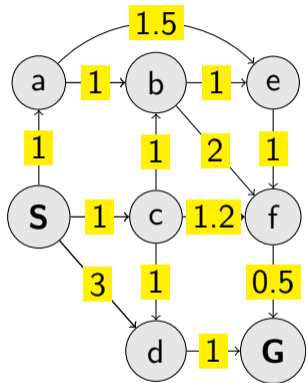

When to stop, when visiting or expanding?

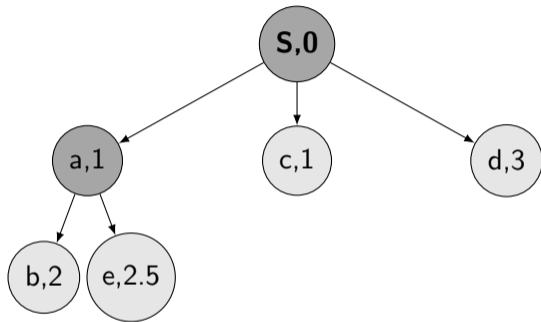
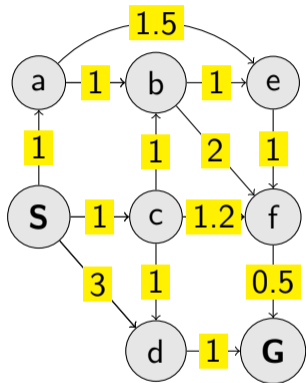

When to stop, when visiting or expanding?

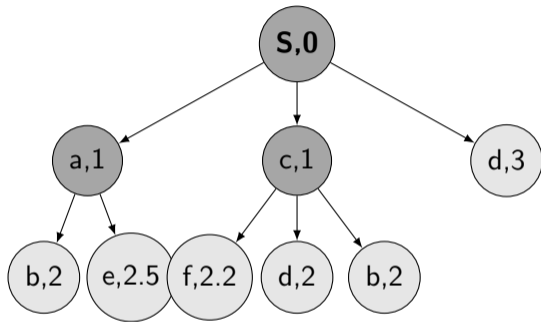
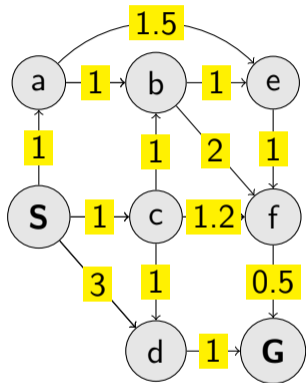

When to stop, when visiting or expanding?

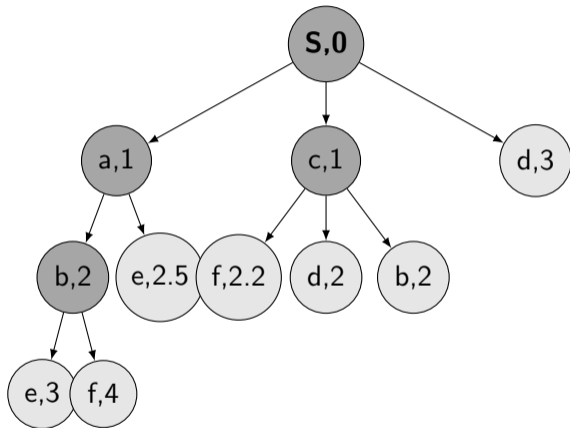
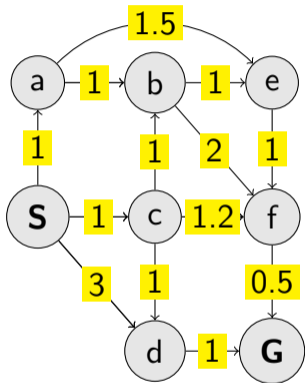

When to stop, when visiting or expanding?

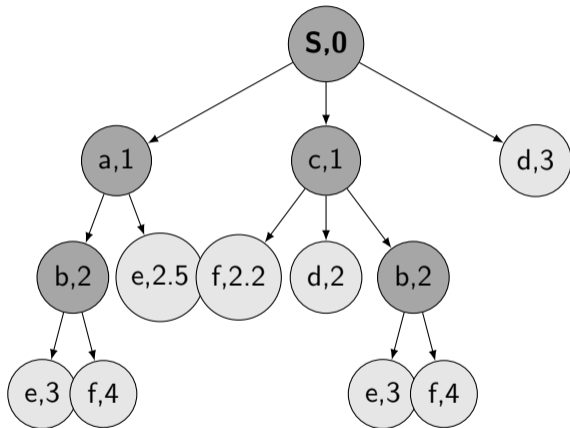
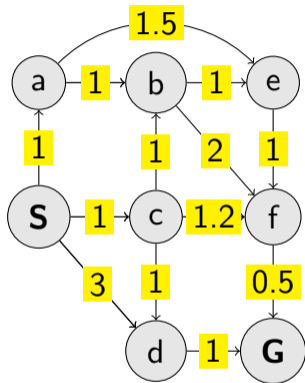

When to stop, when visiting or expanding?

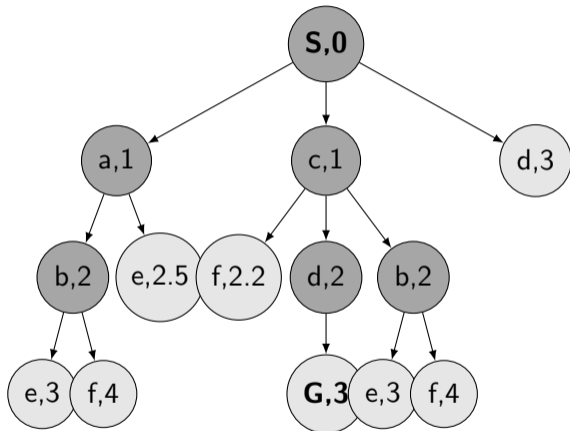
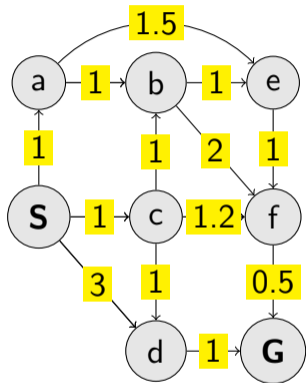

When to stop, when visiting or expanding?

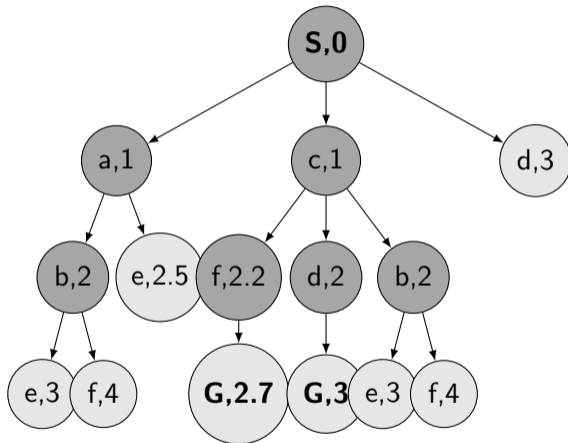
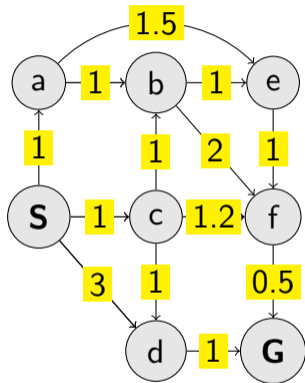

When to stop, when visiting or expanding?

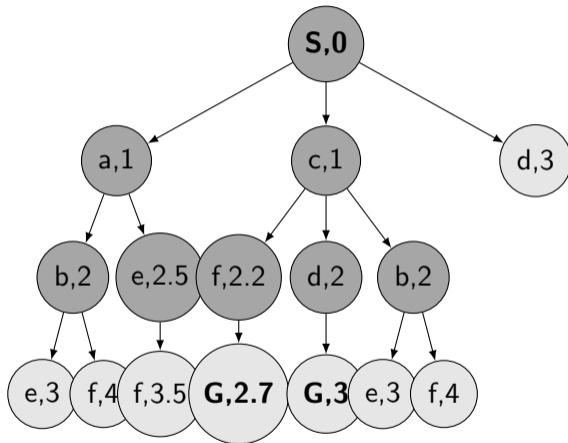
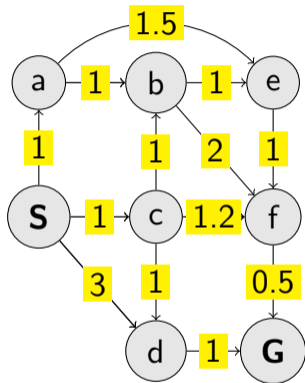

When to stop, when visiting or expanding?

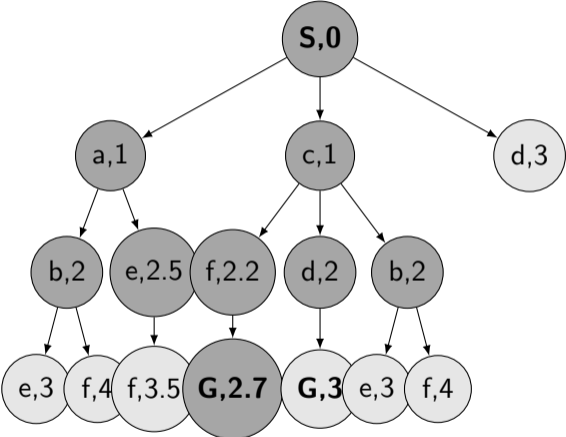
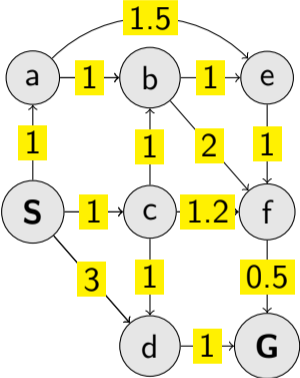

UCS properties

- ▶ Time complexity?
- ▶ Space complexity?
- ▶ Complete?
- ▶ Optimal?

UCS properties

- ▶ Time complexity?
- ▶ Space complexity?
- ▶ Complete?
- ▶ Optimal?

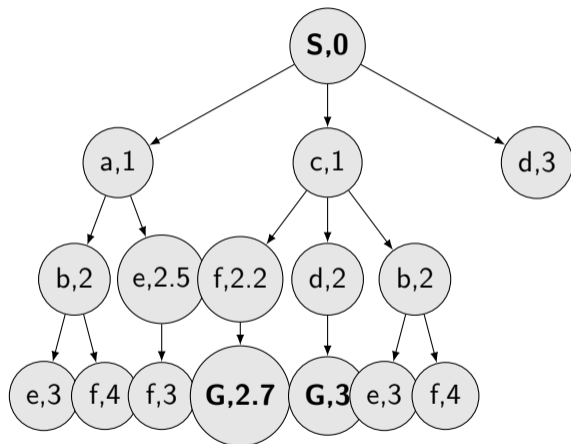

Example: Graph with costs

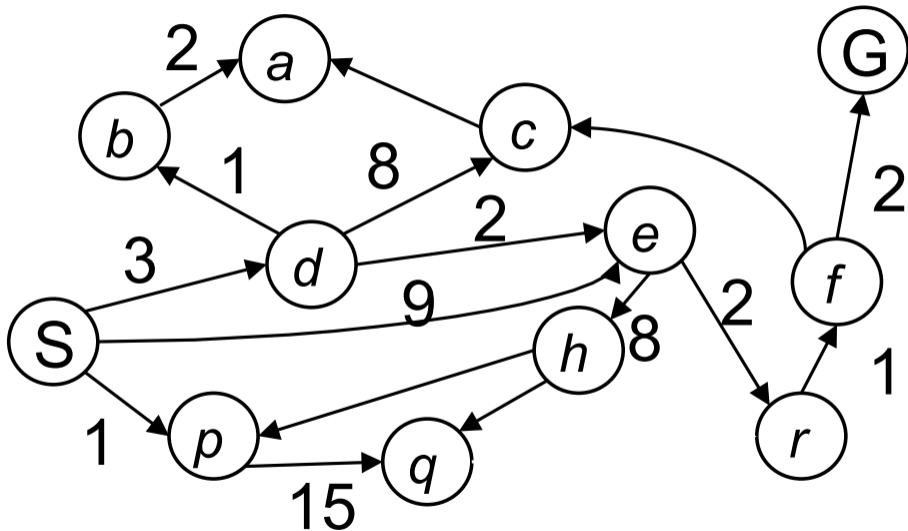

Infrastructure for (tree) search algorithms

What should a **tree node** `n` know?

- ▶ `n.state`
- ▶ `n.parent`
- ▶ `n.pathcost`

Perhaps we may add something later, if needed ...

Infrastructure for (tree) search algorithms

What should a **tree node** `n` know?

- ▶ `n.state`
- ▶ `n.parent`
- ▶ `n.pathcost`

Perhaps we may add something later, if needed ...

How to organize nodes?

The Python examples are just suggestions, ...

- ▶ A dynamically linked structure (`list()`).
- ▶ Add a node (`list.insert(node)`).
- ▶ Take a node and remove from the structure (`node=list.pop()`).
- ▶ Check the Python modules `heapq`¹ and `queue`² for inspiration.

¹<https://docs.python.org/3.5/library/heapq.html>

²<https://docs.python.org/3.5/library/queue.html>

What is the solution?

- ▶ We stop when **Goal** is reached.
- ▶ How do we construct the **path**?

References, further reading

Some figures if from [2]. Chapter 2 in [1] provides a compact/dense intro into search algorithms.

[1] Steven M. LaValle.

Planning Algorithms.

Cambridge, 1st edition, 2006.

Online version available at: <http://planning.cs.uiuc.edu>.

[2] Stuart Russell and Peter Norvig.

Artificial Intelligence: A Modern Approach.

Prentice Hall, 3rd edition, 2010.

<http://aima.cs.berkeley.edu/>.