

**Curvature-Constrained Data Collection Planning  
Dubins Traveling Salesman Problem with Neighborhoods (DTSPN)  
and  
Dubins Orienteering Problem with Neighborhoods (DOPN)**

Jan Faigl

Department of Computer Science  
Faculty of Electrical Engineering  
Czech Technical University in Prague

Lecture 07

**B4M36UIR – Artificial Intelligence in Robotics**



# Overview of the Lecture

- Part 1 – Curvature-Constrained Data Collection Planning
  - Dubins Vehicle and Dubins Planning
  - Dubins Touring Problem (DTP)
  - Dubins Traveling Salesman Problem
  - Dubins Traveling Salesman Problem with Neighborhoods
  - Dubins Orienteering Problem
  - Dubins Orienteering Problem with Neighborhoods
  - Planning in 3D – Examples and Motivations



# Part I

## Part 1 – Curvature-Constrained Data Collection Planning



# Outline

- Dubins Vehicle and Dubins Planning
- Dubins Touring Problem (DTP)
- Dubins Traveling Salesman Problem
- Dubins Traveling Salesman Problem with Neighborhoods
- Dubins Orienteering Problem
- Dubins Orienteering Problem with Neighborhoods
- Planning in 3D – Examples and Motivations



## Motivation – Surveillance Missions with Aerial Vehicles

- Provide **curvature-constrained** path to collect the most valuable measurements with shortest possible path/time or under limited travel budget.

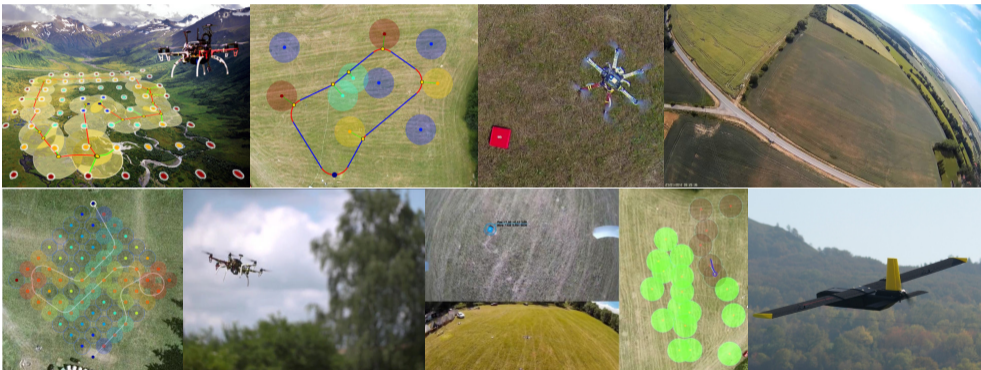

- Formulated as routing problems with Dubins vehicle
  - **Dubins Traveling Salesman Problem with Neighborhoods**
  - **Dubins Orienteering Problem with Neighborhoods**



## Dubins Vehicle

- Non-holonomic vehicle such as car-like or aircraft can be modeled as the Dubins vehicle:
  - Constant forward velocity;
  - Limited minimal turning radius  $\rho$ ;
  - Vehicle state is represented by a triplet  $q = (x, y, \theta)$ , where
  - Position is  $(x, y) \in \mathbb{R}^2$ , vehicle heading is  $\theta \in \mathbb{S}^1$ , and thus  $q \in SE(2)$ .

The vehicle motion can be described by the equation

$$\begin{bmatrix} \dot{x} \\ \dot{y} \\ \dot{\theta} \end{bmatrix} = v \begin{bmatrix} \cos \theta \\ \sin \theta \\ \frac{u}{\rho} \end{bmatrix}, \quad |u| \leq 1,$$

where  $u$  is the control input.

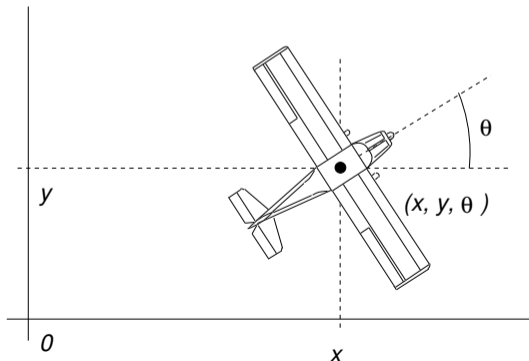

## Optimal Maneuvers for Dubins Vehicle

- For two states  $q_1 \in SE(2)$  and  $q_2 \in SE(2)$  in the environment **without obstacles**  $\mathcal{W} = \mathbb{R}^2$ , the optimal path connecting  $q_1$  with  $q_2$  can be characterized as one of two main types
  - **CCC** type: **LRL**, **RLR**;
  - **CSC** type: **LSL**, **LSR**, **RSL**, **RSR**;

where S – straight line arc, C – circular arc oriented to left (L) or right (R).

*L. E. Dubins (1957) – American Journal of Mathematics*

- The optimal paths are called **Dubins maneuvers**.
  - Constant velocity:  $v(t) = v$  and turning radius  $\rho$ .
  - **Six** types of trajectories connecting any configuration in  $SE(2)$ . *(Without obstacles)*
  - The control  $u$  is according to C and S type one of three possible values  $u \in \{-1, 0, 1\}$ .



## Parametrization of Dubins Maneuvers

- Parametrization of each trajectory phase:

$$\{L_\alpha R_\beta L_\gamma, R_\alpha L_\beta R_\gamma, L_\alpha S_d L_\gamma, L_\alpha S_d R_\gamma, R_\alpha S_d L_\gamma, R_\alpha S_d R_\gamma\}$$

for  $\alpha \in [0, 2\pi)$ ,  $\beta \in (\pi, 2\pi)$ ,  $d \geq 0$ .

Notice the prescribed orientation at  $q_0$  and  $q_f$ .

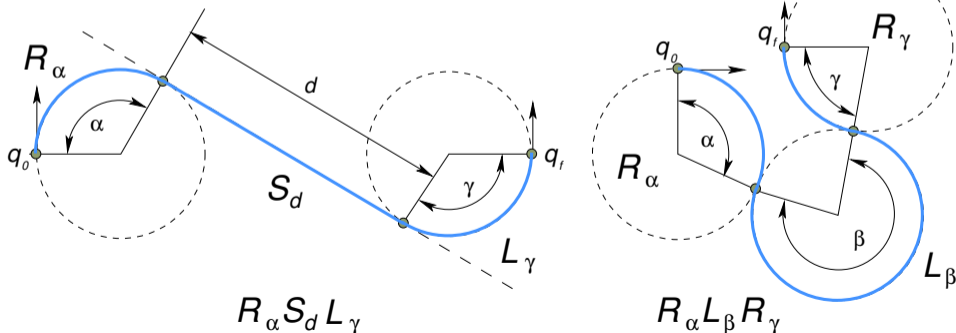



## Multi-goal Dubins Path

- Minimal turning radius  $\rho$  and constant forward velocity  $v$ .
- State of the Dubins vehicle is  $q = (x, y, \theta)$ ,  $q \in SE(2)$ ,  $(x, y) \in \mathbb{R}^2$  and  $\theta \in \mathbb{S}^1$ .

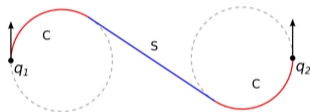
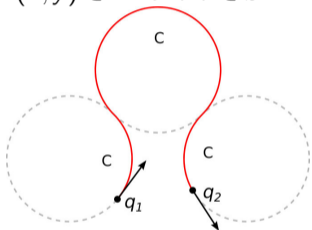

Smooth Dubins path connecting a sequence of locations is also suitable for multi-rotor aerial vehicle.

$$\begin{bmatrix} \dot{x} \\ \dot{y} \\ \dot{\theta} \end{bmatrix} = v \begin{bmatrix} \cos \theta \\ \sin \theta \\ \frac{u}{\rho} \end{bmatrix}$$

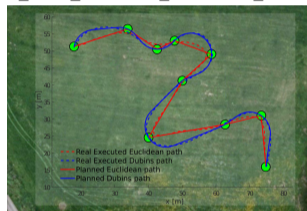

- Optimal path connecting  $q_1 \in SE(2)$  and  $q_2 \in SE(2)$  consists only of straight line arcs and arcs with the maximal curvature, i.e., two types of maneuvers CCC and CSC and the solution can be found analytically.

(Dubins, 1957)

- In **multi-goal Dubins path planning**, we need to solve the underlying TSP.



## Difficulty of Dubins Vehicle in the Solution of the TSP

- For the minimal turning radius  $\rho$ , the **optimal path** connecting  $\mathbf{q}_1 \in SE(2)$  and  $\mathbf{q}_2 \in SE(2)$  can be found analytically.

L. E. Dubins (1957) – American Journal of Mathematics

- Two types of optimal Dubins maneuvers: CSC and CCC.
- The length of the optimal maneuver  $\mathcal{L}$  has a closed-form solution.
  - It is **piecewise-continuous function**; *Can be computed in less than 0.5  $\mu$ s*
  - (continuous for  $\|(\mathbf{p}_1, \mathbf{p}_2)\| > 4\rho$ ).

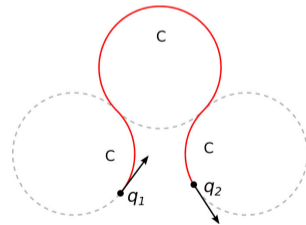
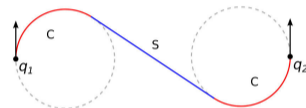
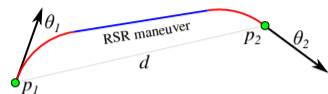
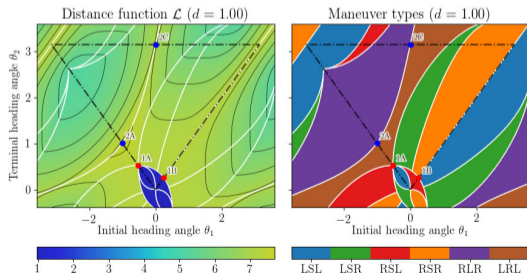

## Dubins Traveling Salesman Problem (DTSP)

- Determine (closed) shortest Dubins path visiting each  $\mathbf{p}_i \in \mathbb{R}^2$  of the given set of  $n$  locations  $P = \{\mathbf{p}_1, \dots, \mathbf{p}_n\}$ .

1. Permutation  $\Sigma = (\sigma_1, \dots, \sigma_n)$  of visits (sequencing).

*Combinatorial optimization*

2. Headings  $\Theta = \{\theta_{\sigma_1}, \theta_{\sigma_2}, \dots, \theta_{\sigma_n}\}$ ,  $\theta_i \in [0, 2\pi)$ , for  $\mathbf{p}_{\sigma_i} \in P$ .

*Continuous optimization*

- **DTSP** is an optimization problem over all possible **sequences**  $\Sigma$  and **headings**  $\Theta$  at the states  $(\mathbf{q}_{\sigma_1}, \mathbf{q}_{\sigma_2}, \dots, \mathbf{q}_{\sigma_n})$  such that

$$\mathbf{q}_{\sigma_i} = (\mathbf{p}_{\sigma_i}, \theta_{\sigma_i}), \mathbf{p}_{\sigma_i} \in P$$

$$\text{minimize}_{\Sigma, \Theta} \sum_{i=1}^{n-1} \mathcal{L}(\mathbf{q}_{\sigma_i}, \mathbf{q}_{\sigma_{i+1}}) + \mathcal{L}(\mathbf{q}_{\sigma_n}, \mathbf{q}_{\sigma_1}) \quad \text{where}$$

$$\text{subject to} \quad \mathbf{q}_i = (\mathbf{p}_i, \theta_i) \quad i = 1, \dots, n,$$

$\mathcal{L}(\mathbf{q}_{\sigma_i}, \mathbf{q}_{\sigma_j})$  is the length of Dubins path between  $\mathbf{q}_{\sigma_i}$  and  $\mathbf{q}_{\sigma_j}$ .

The continuous domain of the heading angles is similar to the regions in the TSPN-like problem formulations.

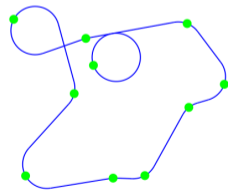
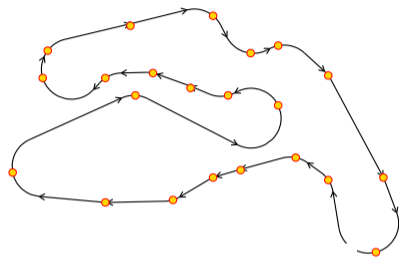

# Challenges of the Dubins Traveling Salesman Problem

- The key difficulty of the DTSP is that the path length mutually depends on

- Order of the visits to the locations;
- Headings at the target locations.

*We need the sequence to determine headings, but headings may influence the sequence.*

- The Dubins TSP is **sequence dependent problem**.
- Two fundamental approaches can be found in literature.

1. **Decoupled** approach based on a given sequence of the locations, e.g., found by a solution of the Euclidean TSP.
2. **Sampling-based** approach with sampling of the headings at the locations into discrete sets of values and considering the problem as the variant of the **Generalized TSP**.

Besides, further approaches are

- Genetic and memetic techniques (evolutionary algorithms);
- Unsupervised learning based approaches.

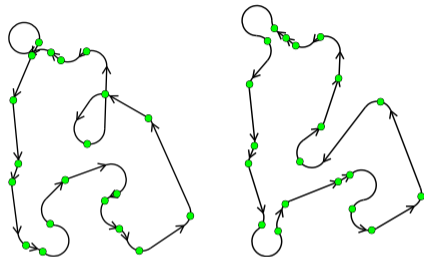

## Existing Approaches to the DTSP(N)

### ■ Heuristic (decoupled & evolutionary) approaches

- *Savla et al., 2005*
- *Ma and Castanon, 2006*
- *Macharet et al., 2011*
- *Macharet et al., 2012*
- *Ny et al., 2012*
- *Yu and Hang, 2012*
- *Macharet et al., 2013*
- *Zhant et al., 2014*
- *Macharet and Campost, 2014*
- *Váňa and Faigl, 2015*
- *Isaiah and Shima, 2015*
- ...

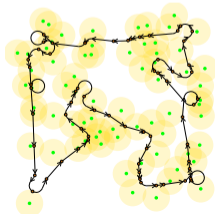
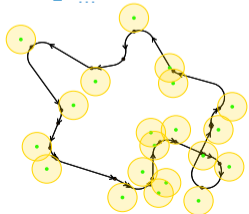

### ■ Sampling-based approaches

- *Obermeyer, 2009*
- *Oberlin et al., 2010*
- *Macharet et al., 2016*

### ■ Convex optimization

- (Only if the locations are far enough)
- *Goac et al., 2013*

### ■ Lower bound for the DTSP

- Dubins Interval Problem (DIP)
- *Manyam et al., 2016*
- DIP-based inform sampling
- *Váňa and Faigl, 2017*

### ■ Lower bound for the DTSPN

- Using Generalized DIP (GDIP)
- *Váňa and Faigl, 2018, 2020*



## Planning with Dubins Vehicle – Summary

- The optimal path connecting two configurations can be found analytically.  
*E.g., for UAVs that usually operates in environment without obstacles.*
- The Dubins maneuvers can also be used in randomized-sampling based motion planners, such as RRT, in the control based sampling.
- Dubins vehicle model can be considered in the multi-goal path planning such as surveillance, inspection or monitoring missions to periodically visits given target locations (areas).

- **Dubins Touring Problem (DTP)**

Given a sequence of locations, what is the shortest path visting the locations, i.e., what are the headings of the vehicle at the locations.

- **Dubins Traveling Salesman Problem (DTSP)**

Given a set of locations, what is the shortest Dubins path that visits each location exactly once and returns to the origin location.

- **Dubins Orienteering Problem (DOP)**

Given a set of locations, each with associated reward, what is the Dubins path visting the most rewarding locations and not exceeding the given travel budget.



# Outline

- Dubins Vehicle and Dubins Planning
- Dubins Touring Problem (DTP)
- Dubins Traveling Salesman Problem
- Dubins Traveling Salesman Problem with Neighborhoods
- Dubins Orienteering Problem
- Dubins Orienteering Problem with Neighborhoods
- Planning in 3D – Examples and Motivations



## Dubins Touring Problem – DTP

- For a sequence of the  $n$  waypoint locations  $P = (p_1, \dots, p_n)$ ,  $p_i \in \mathbb{R}^2$ , the **Dubins Touring Problem (DTP)** stands to determine the **optimal headings**  $T = \{\theta_1, \dots, \theta_n\}$  at the waypoints  $q_i$  such that

$$\begin{aligned} \text{minimize } T \quad & \mathcal{L}(T, P) = \sum_{i=1}^{n-1} \mathcal{L}(q_i, q_{i+1}) + \mathcal{L}(q_n, q_1) \\ \text{subject to} \quad & q_i = (p_i, \theta_i), \quad \theta_i \in [0, 2\pi), \quad p_i \in P, \end{aligned}$$

where  $\mathcal{L}(q_i, q_j)$  is the length of the Dubins maneuver connecting  $q_i$  with  $q_j$ .

- The DTP is a **continuous optimization problem**.
- The term  $\mathcal{L}(q_n, q_1)$  is for possibly closed tour that can be for example requested in the TSP with Dubins vehicle, a.k.a. DTSP.

*On the other, the DTP can also be utilized for open paths such as solutions of the OP with Dubins vehicle.*

- In some cases, it may be suitable to relax the heading at the first/last locations in finding closed tours (i.e., solving DTSP).





## Sampling-based Solution of the DTP

- For a closed sequence of the waypoint locations

$$P = (p_1, \dots, p_n).$$

- We can sample possible heading values at each location  $i$  into a discrete set of  $k$  headings, i.e.,  $\Theta^i = \{\theta_1^i, \dots, \theta_k^i\}$  and create a graph of all possible Dubins maneuvers.

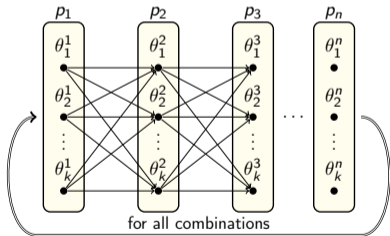

- For a set of heading samples, the optimal solution can be found by a forward search of the graph in  $O(nk^3)$ .

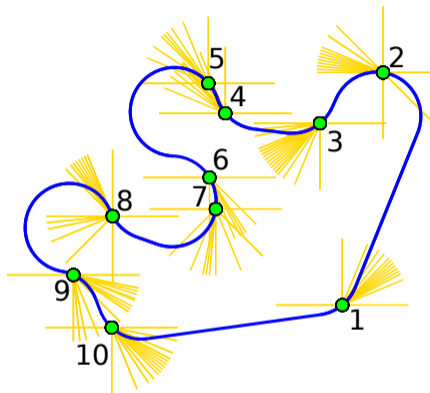

For open sequence we do not need to evaluate all possible initial headings, and the complexity is  $O(nk^2)$ .

- The problem is to determine the most suitable heading samples.**



## Example of Heading Sampling – Uniform vs. Informed

### Uniform sampling

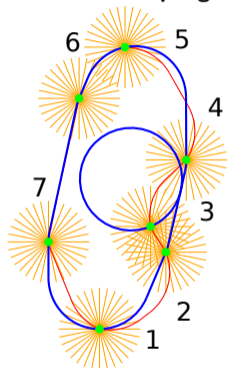

$$N = 224, T_{cpu} = 128 \text{ ms}$$

$$\mathcal{L} = 19.8, \mathcal{L}_U = 13.8$$

### Informed sampling

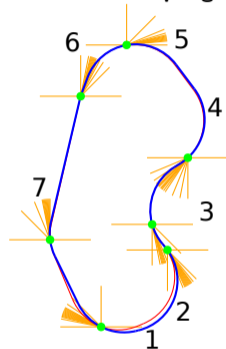

$$N = 128, T_{cpu} = 76 \text{ ms}$$

$$\mathcal{L} = 14.4, \mathcal{L}_U = 14.2.$$

- $N$  is the total number of samples, i.e., 32 samples per waypoint for uniform sampling.
- $\mathcal{L}$  is the length of the tour (blue) and  $\mathcal{L}_U$  is the lower bound (red) determined as a solution of the **Dubins Interval Problem (DIP)**.



## Dubins Interval Problem (DIP)

- **Dubins Interval Problem (DIP)** is a generalization of Dubins maneuvers to the shortest path connecting two points  $p_i$  and  $p_j$ .
- In the DIP, the leaving interval  $\Theta_i$  at  $p_i$  and the arrival interval  $\Theta_j$  at  $p_j$  are considered (not a single heading value).
- The optimal solution can be found analytically.

*Manyam et al. (2015)*

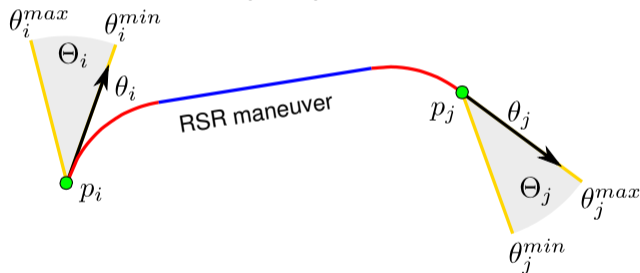

- Solution of the DIP is a tight lower bound for the DTP.
- Solution of the DIP is not a feasible solution of the DTP.

*Notice, for  $\Theta_i = \Theta_j = \langle 0, 2\pi \rangle$  the optimal maneuver for DIP is a straight line segment.*



## Lower Bound of the DTP

- For a discrete set of heading intervals  $\mathcal{H} = \{H_1, \dots, H_n\}$ , where  $H_i = \{\Theta_i^1, \Theta_i^2, \dots, \Theta_i^{k_i}\}$ , a similar graph as for the DTP can be constructed with the edge cost determined by the solution of the associated DIP.

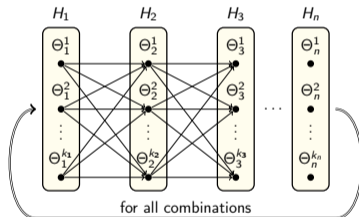

- The forward search of the graph with dense samples provides a **tight lower bound of the DTP**. *Manyam and Rathinam, 2015*

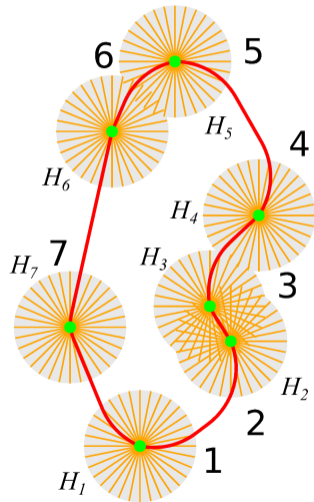

## Lower Bound and Feasible Solution of the DTP

- The arrival and departure angles may not be the same.

*The lower bound solution is not a feasible solution of the DTP.*

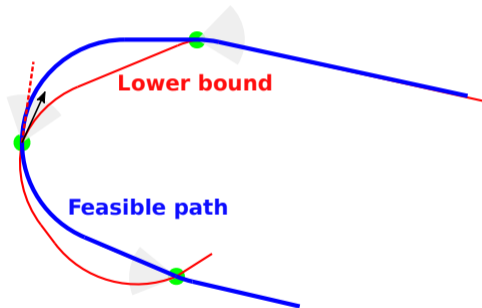

- **DTP solution** – use any particular heading of each interval in the lower bound solution.



## The DIP-based Sampling of Headings in the DTP

- Using heading intervals for a sequence of waypoints and a solution of the DIP, we can determine **lower bound** of the DTP using the forward search graph as for the DTP.
- The ratio between the lower bound and feasible solution of the DTP provides an estimation of the solution quality.

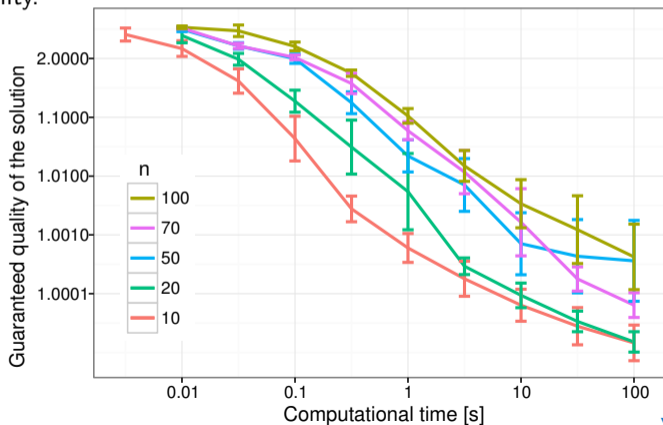

Váňa and Faigl (2016)



# Iteratively-Refined Informed Sampling (IRIS) of Headings in the Solution of the DTP

- Iterative refinement of the heading intervals  $\mathcal{H}$  up to the angular resolution  $\epsilon_{req}$ .
- The angular resolution is gradually decreased for the most promising intervals.
- **refineDTP** – divide the intervals of the lower bound solution.
- **solveDTP** – solve DTP using the heading from the refined intervals.
- It simultaneously provides **feasible** and **lower bound** solutions of the DTP.
 

*The lower bound provides a tight estimation of the solution quality.*
- The first solution is provided very quickly – **any-time algorithm**.

---

## Algorithm 1: Iterative Informed Sampling-based DTP Algorithm

---

**Input:**  $P$  – Target locations to be visited  
**Input:**  $\epsilon_{req}$  – Requested angular resolution  
**Input:**  $\alpha_{req}$  – Requested quality of the solution  
**Output:**  $T$  – A tour visiting the targets

---

```

 $\epsilon \leftarrow 2\pi$  // initial angular resolution;
 $\mathcal{H} \leftarrow \text{createIntervals}(P, \epsilon)$  // initial intervals;
 $\mathcal{L}_L \leftarrow 0$  // init lower bound;
 $\mathcal{L}_U \leftarrow \infty$  // init upper bound;
while  $\epsilon > \epsilon_{req}$  and  $\mathcal{L}_U / \mathcal{L}_L > \alpha_{req}$  do
  |  $\epsilon \leftarrow \epsilon / 2$ ;
  |  $(\mathcal{H}, \mathcal{L}_L) \leftarrow \text{refineDTP}(P, \epsilon, \mathcal{H})$ ;
  |  $(T, \mathcal{L}_U) \leftarrow \text{solveDTP}(P, \mathcal{H})$ ;
end
return  $T$ ;

```

---

Faigl, J., Váňa, P., Saska, M., Báča, T., and Spurný, V.: *On solution of the Dubins touring problem*, **ECMR**, 2017.



# Uniform vs Informed Sampling

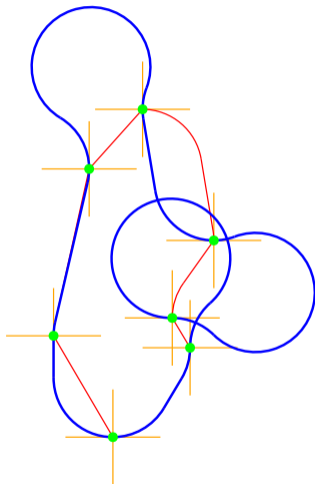

$$\epsilon = 2\pi/4, N = 28, T_{\text{CPU}} = 8 \text{ ms}$$

$$\mathcal{L} = 27.9, \mathcal{L}_U = 13.2$$

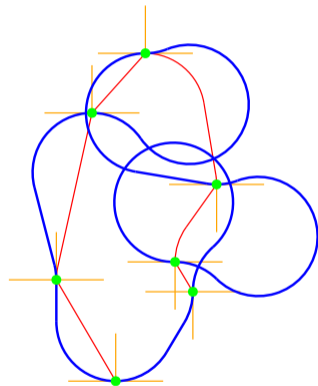

$$\epsilon = 2\pi/4, N = 21, T_{\text{CPU}} = 8 \text{ ms}$$

$$\mathcal{L} = 29.9, \mathcal{L}_U = 13.2$$





# Uniform vs Informed Sampling

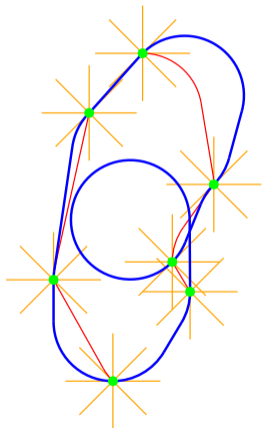

$\epsilon = 2\pi/8$ ,  $N = 56$ ,  $T_{\text{CPU}} = 16$  ms  
 $\mathcal{L} = 20.8$ ,  $\mathcal{L}_U = 13.2$

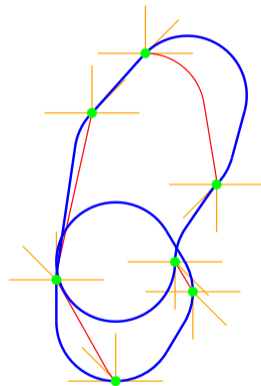

$\epsilon = 2\pi/8$ ,  $N = 28$ ,  $T_{\text{CPU}} = 20$  ms  
 $\mathcal{L} = 21.0$ ,  $\mathcal{L}_U = 13.2$



# Uniform vs Informed Sampling

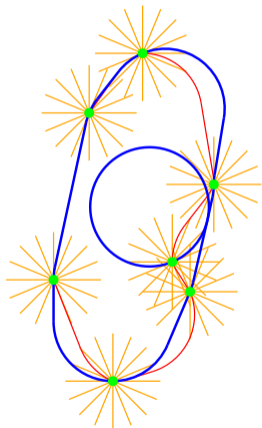

$\epsilon = 2\pi/16$ ,  $N = 112$ ,  $T_{\text{CPU}} = 40$  ms  
 $\mathcal{L} = 20.3$ ,  $\mathcal{L}_U = 13.5$

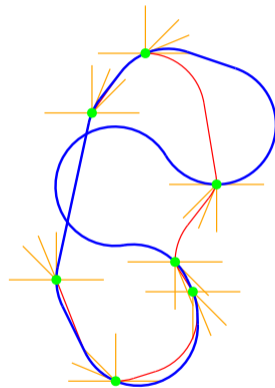

$\epsilon = 2\pi/16$ ,  $N = 35$ ,  $T_{\text{CPU}} = 24$  ms  
 $\mathcal{L} = 20.1$ ,  $\mathcal{L}_U = 13.5$



# Uniform vs Informed Sampling

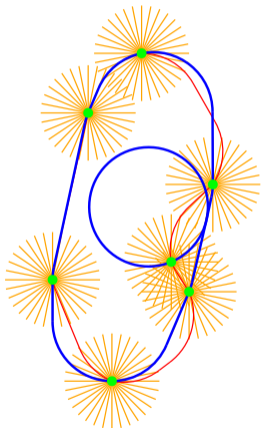

$\epsilon = 2\pi/32$ ,  $N = 224$ ,  $T_{\text{CPU}} = 140$  ms  
 $\mathcal{L} = 19.8$ ,  $\mathcal{L}_U = 13.8$

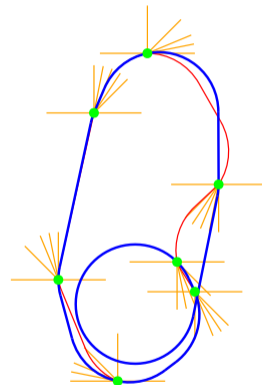

$\epsilon = 2\pi/32$ ,  $N = 44$ ,  $T_{\text{CPU}} = 32$  ms  
 $\mathcal{L} = 19.9$ ,  $\mathcal{L}_U = 13.8$



# Uniform vs Informed Sampling

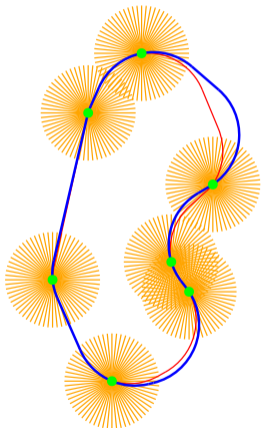

$\epsilon = 2\pi/64$ ,  $N = 448$ ,  $T_{\text{CPU}} = 456$  ms  
 $\mathcal{L} = 14.5$ ,  $\mathcal{L}_U = 14.5$

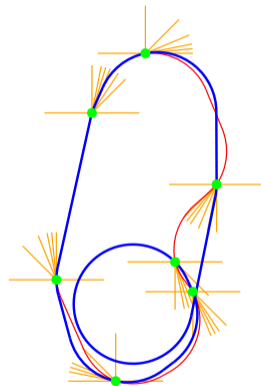

$\epsilon = 2\pi/64$ ,  $N = 51$ ,  $T_{\text{CPU}} = 48$  ms  
 $\mathcal{L} = 19.9$ ,  $\mathcal{L}_U = 13.9$



# Uniform vs Informed Sampling

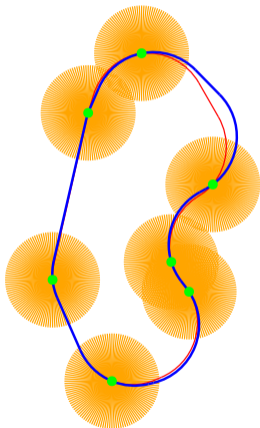

$\epsilon = 2\pi/128$ ,  $N = 896$ ,  $T_{\text{CPU}} = 1620$  ms  
 $\mathcal{L} = 14.5$ ,  $\mathcal{L}_U = 14.5$

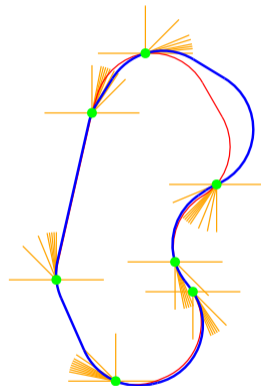

$\epsilon = 2\pi/128$ ,  $N = 70$ ,  $T_{\text{CPU}} = 60$  ms  
 $\mathcal{L} = 14.8$ ,  $\mathcal{L}_U = 14.1$



# Uniform vs Informed Sampling

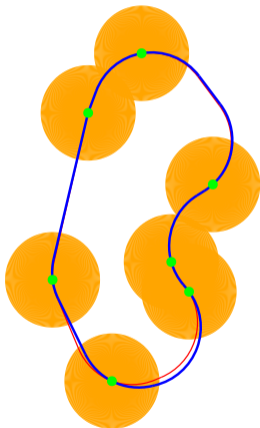

$\epsilon = 2\pi/256$ ,  $N = 1792$ ,  $T_{\text{CPU}} = 6784$  ms  
 $\mathcal{L} = 14.4$ ,  $\mathcal{L}_U = 14.3$

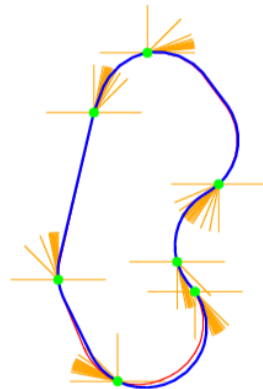

$\epsilon = 2\pi/256$ ,  $N = 100$ ,  $T_{\text{CPU}} = 88$  ms  
 $\mathcal{L} = 14.4$ ,  $\mathcal{L}_U = 14.3$



## Results and Comparison with Uniform Sampling

- Random instances of the DTSP with a sequence of visits to the targets determined as a solution of the Euclidean TSP.
- The waypoints placed in a squared bounding box with the side  $s = (\rho\sqrt{n})/d$  for the  $\rho = 1$  and density  $d = 0.5$ .

It matters on the density of targets!

Quality of solution for increasing  $n$

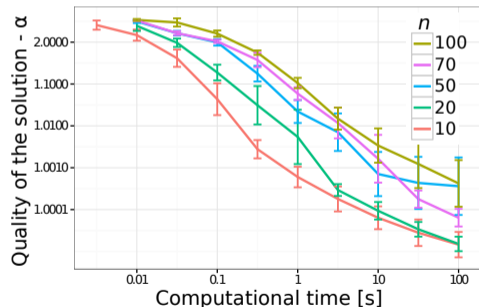

Comparison with the uniform sampling

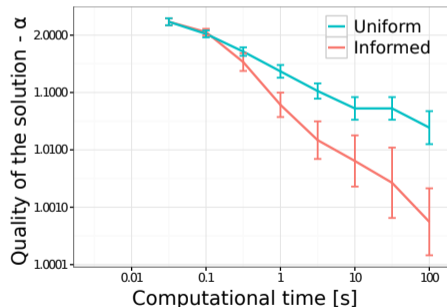

- The informed sampling-based approach provides solutions up to 0.01% from the optima.
- A solution of the DTP is a fundamental building block for **routing problems with Dubins vehicle**.



# Outline

- Dubins Vehicle and Dubins Planning
- Dubins Touring Problem (DTP)
- **Dubins Traveling Salesman Problem**
- Dubins Traveling Salesman Problem with Neighborhoods
- Dubins Orienteering Problem
- Dubins Orienteering Problem with Neighborhoods
- Planning in 3D – Examples and Motivations





## Dubins Traveling Salesman Problem (DTSP)

1. Determine a closed shortest Dubins path visiting each location  $p_i \in P$  of the given set of  $n$  locations  $P = \{p_1, \dots, p_n\}$ ,  $p_i \in \mathbb{R}^2$ .
2. Permutation  $\Sigma = (\sigma_1, \dots, \sigma_n)$  of visits.
3. Headings  $\Theta = \{\theta_{\sigma_1}, \theta_{\sigma_2}, \dots, \theta_{\sigma_n}\}$  for  $p_{\sigma_i} \in P$ .

*Sequencing part of the problem*

*Continuous optimization*

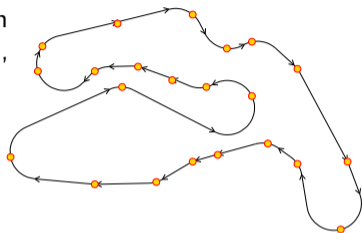

- **DTSP** is an optimization problem over all possible **permutations**  $\Sigma$  and **headings**  $\Theta$  in the states  $(q_{\sigma_1}, q_{\sigma_2}, \dots, q_{\sigma_n})$  such that  $q_{\sigma_i} = (p_{\sigma_i}, \theta_{\sigma_i})$

$$\begin{aligned} \text{minimize}_{\Sigma, \Theta} \quad & \sum_{i=1}^{n-1} \mathcal{L}(q_{\sigma_i}, q_{\sigma_{i+1}}) + \mathcal{L}(q_{\sigma_n}, q_{\sigma_1}) \\ \text{subject to} \quad & q_i = (p_i, \theta_i) \quad i = 1, \dots, n, \end{aligned}$$

where  $\mathcal{L}(q_{\sigma_i}, q_{\sigma_j})$  is the length of Dubins path between  $q_{\sigma_i}$  and  $q_{\sigma_j}$ .



## Decoupled Solution of the DTSP – Alternating Algorithm

**Alternating Algorithm (AA)** provides a solution of the DTSP for an **even** number of targets  $n$ .

Savla, K., Frazzoli, E., Bullo, F.: *On the point-to-point and traveling salesperson problems for Dubins' vehicle*, IEE American Control Conference, 2005.

1. Solve the related Euclidean TSP.  
*Relaxed motion constraints*
2. Establish headings for even edges using straight line segments.
3. Determine optimal maneuvers for odd edges using the analytical form for Dubins maneuvers.  
*Headings are known.*

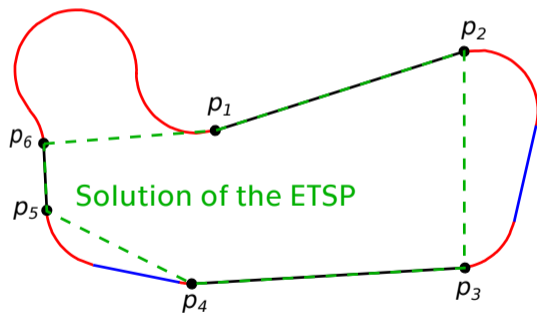

Courtesy of P. Váňa



## DTSP with the Given Sequence of the Visits to the Targets

- If the sequence of the visits  $\Sigma$  to the target locations is given.
- the problem is to determine the optimal heading at each location.
- and the problem becomes the **Dubins Touring Problem (DTP)**.
- Let for each location  $g_i \in G$  sample possible heading to  $k$  values, i.e., for each  $g_i$  the set of headings be  $h_i = \{\theta_1^1, \dots, \theta_1^k\}$ .
- Since  $\Sigma$  is given, we can construct a graph connecting two consecutive locations in the sequence by all possible headings.
- For such a graph and particular headings  $\{h_1, \dots, h_n\}$ , we can find an optimal headings and thus, **the optimal solution of the DTP**.



## DTSP as a Solution of the DTP

The first layer is duplicated layer to support the forward search method

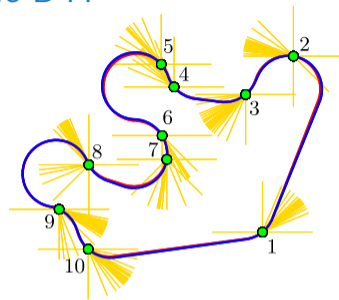
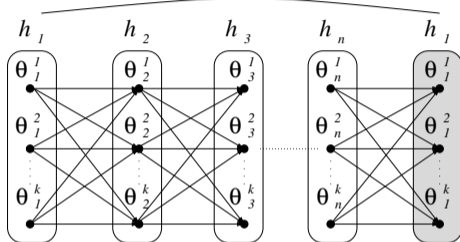

- The edge cost corresponds to the length of Dubins maneuver.
- Better solution of the DTP can be found for more samples, which will also improve the DTSP but only for the given sequence.

*Two questions arise for a practical solution of the DTP.*

- **How to sample the headings?** More samples makes finding solution more demanding.

*We need to sample the headings in a "smart" way, i.e., guided sampling using lower bound of the DTP?*

- **What is the solution quality?** Is there a tight lower bound?

*Yes, the lower bound can be computed as a solution of the Dubins Interval Problem (DIP).*



## DTP Solver in Solution of the DTSP

- The solution of the DTP can be used to solve DTSP for the given sequence of the waypoints.

*E.g., determined as a solution of the Euclidean TSP as in the Alternating Algorithm.*

- Comparison with the Alternating Algorithm (AA), Local Iterative Optimization (LIO), and Memetic algorithm.

AA – Savla et al., 2005, LIO – Váňa & Faigl, 2015, Memetic – Zhang et al. 2014

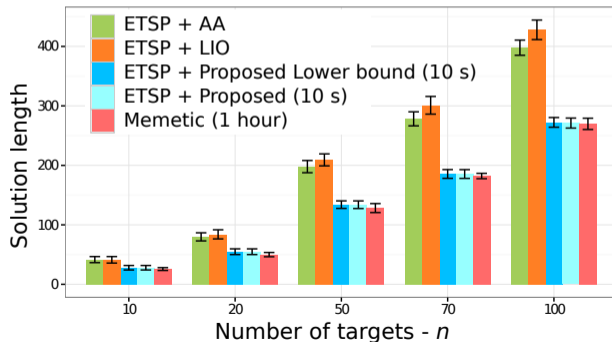

## DTSP – Sampling-based Approach

- Sampled heading values can be directly utilized to find the sequence as a solution of the **Generalized Traveling Salesman Problem (GTSP)**.

*Notice For Dubins vehicle, it is the Generalized Asymmetric TSP (GATSP).*

The problem is to determine a shortest tour in a graph that visits all specified subsets of the graph's vertices.

*The TSP is a special case of the GTSP when each subset to be visited consists just a single vertex.*

- GATSP  $\rightarrow$  ATSP;

*Noon and Bean (1991)*

- ATSP can be solved by LKH;
- ATSP  $\rightarrow$  TSP, which can be solved optimally, e.g., by Concorde.

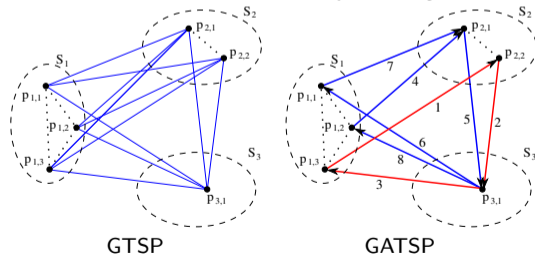

## DTSP – Evolutionary Approach with Surrogate Model

- Use standard genetic operators with tournament selection and OX1 crossover method.
- The population is evaluated using learned surrogate model based on multi-layer perceptron.
- The surrogate model estimates solution cost of candidate sequences (instances of the DTP).
- Massive speedup of the evaluation yields improved solutions and scalability.

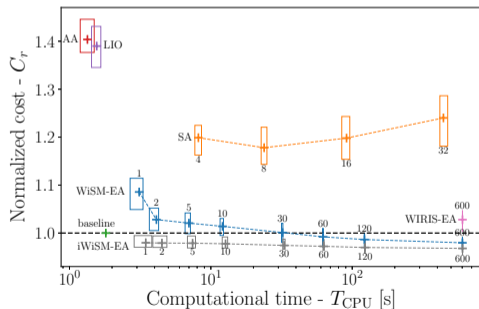

Instances with low density  $d$  and  $n = 100$  target locations

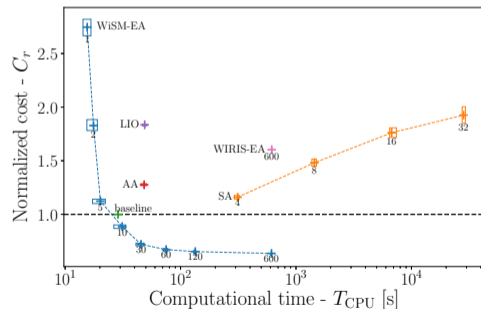

Instances with high density  $d$  and  $n = 500$  target locations

Drchal, J., Váňa, P., and Faigl, J.: *WiSM: Windowing Surrogate Model for Evaluation of Curvature-Constrained Tours with Dubins vehicle*, IEEE Transactions on Cybernetics, 2020.



# Outline

- Dubins Vehicle and Dubins Planning
- Dubins Touring Problem (DTP)
- Dubins Traveling Salesman Problem
- **Dubins Traveling Salesman Problem with Neighborhoods**
- Dubins Orienteering Problem
- Dubins Orienteering Problem with Neighborhoods
- Planning in 3D – Examples and Motivations





## Dubins Traveling Salesman Problem with Neighborhoods

- In surveillance planning, it may be required to visit a set of target regions  $\mathbf{G} = \{R_1, \dots, R_n\}$  by the Dubins vehicle.
- Then, for each target region  $R_i$ , we have to determine a particular point of the visit  $p_i \in R_i$  and DTSP becomes the **Dubins Traveling Salesman Problem with Neighborhoods (DTSPN)**.  
*In addition to  $\Sigma$  and headings  $\Theta$ , waypoint locations  $P$  have to be determined.*
- DTSPN is an optimization problem over all permutations  $\Sigma$ , headings  $\Theta = \{\theta_{\sigma_1}, \dots, \theta_{\sigma_n}\}$  and points  $P = (p_{\sigma_1}, \dots, p_{\sigma_n})$  for the states  $(q_{\sigma_1}, \dots, q_{\sigma_n})$  such that  $q_{\sigma_i} = (p_{\sigma_i}, \theta_{\sigma_i})$  and  $p_{\sigma_i} \in R_{\sigma_i}$ :

$$\begin{aligned} & \text{minimize}_{\Sigma, \Theta, P} && \sum_{i=1}^{n-1} \mathcal{L}(q_{\sigma_i}, q_{\sigma_{i+1}}) + \mathcal{L}(q_{\sigma_n}, q_{\sigma_1}) \\ & \text{subject to} && q_i = (p_i, \theta_i), p_i \in R_i \quad i = 1, \dots, n. \end{aligned}$$

- $\mathcal{L}(q_{\sigma_i}, q_{\sigma_j})$  is the length of the shortest possible Dubins maneuver connecting the states  $q_{\sigma_i}$  and  $q_{\sigma_j}$ .



## DTSPN – Approches and Examples of Solution

- Similarly to the DTSP, also the DTSPN can be addressed by
  - **Decoupled approaches** for which a sequence of visits to the regions can be found as a solution of the ETSP(N);
  - **Sampling-based approaches** and formulation as the GATSP.
    - Clusters of sampled waypoint locations each with sampled possible heading values.
  - **Soft-computing** techniques such as memetic algorithms.
  - **Unsupervised learning** techniques.

Váňa and Faigl (IROS 2015), Faigl and Váňa (ICANN 2016, IJCNN 2017)

- Similarly to the lower bound of the DTSP based on the **Dubins Interval Problem** (DIP) a lower bound for the DTSPN can be computed using the **Generalized DIP** (GDIP).

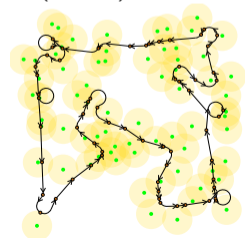
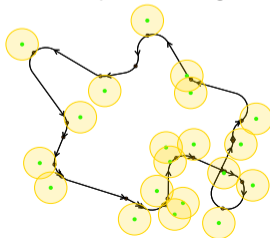
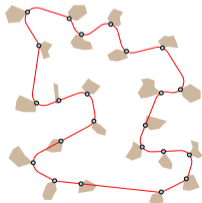

## DTSPN – Decoupled Approach

1. Determine a sequence of visits to the  $n$  target regions as the solution of the ETSP.
2. Sample possible waypoint locations and for each such a location sample possible heading values, e.g.,  $s$  locations per each region and  $h$  heading per each location.
3. Construct a search graph and determine a solution in  $O(n(sh)^3)$ .
4. An example of the search graph for  $n = 6$ ,  $s = 6$ , and  $h = 6$ .

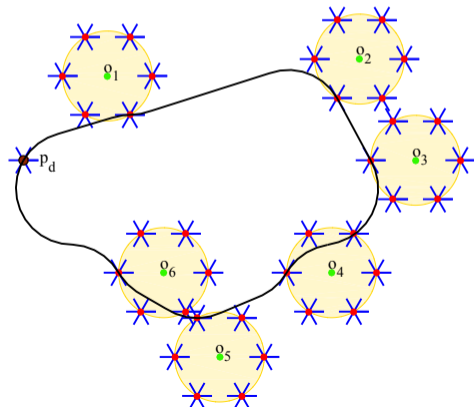
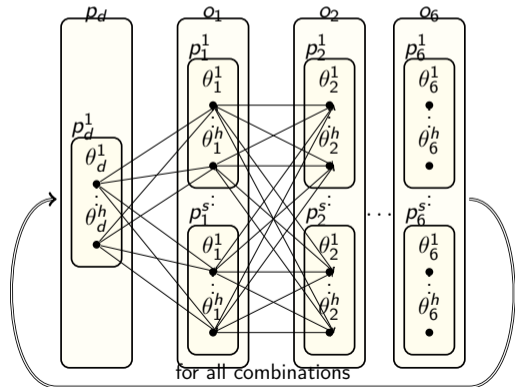

## DTSPN – Local Iterative Optimization (LIO)

- Instead of sampling into a discrete set of waypoint locations each with sampled possible headings, we can perform local optimization, e.g., hill-climbing technique.
- At each waypoint location  $p_i$ , the heading can be  $\theta_i \in [0, 2\pi)$ .
- A waypoint location  $p_i$  can be parametrized as a point on the boundary of the respective region  $R_i$ , i.e., as a parameter  $\alpha \in [0, 1)$  measuring a normalized distance on the boundary of  $R_i$ .
- The multi-variable optimization is treated independently for each particular variable  $\theta_i$  and  $\alpha_i$  iteratively.

---

**Algorithm 2:** Local Iterative Optimization (LIO) for the DTSPN

---

**Data:** Input sequence of the goal regions

$\mathbf{G} = (R_{\sigma_1}, \dots, R_{\sigma_n})$ , for the permutation  $\Sigma$

**Result:** Waypoints  $(q_{\sigma_1}, \dots, q_n)$ ,  $q_i = (p_i, \theta_i)$ ,

$p_i \in \delta R_i$

initialization() // random assignment of  $q_i \in \delta R_i$ ;

**while** *global solution is improving* **do**

**for** every  $R_i \in \mathbf{G}$  **do**

$\theta_i := \text{optimizeHeadingLocally}(\theta_i)$ ;

$\alpha_i := \text{optimizePositionLocally}(\alpha_i)$ ;

$q_i := \text{checkLocalMinima}(\alpha_i, \theta_i)$ ;

**end**

**end**

---

Váňa, P. and Faigl, J.: *On the Dubins Traveling Salesman Problem with Neighborhoods*, IROS, 2015, pp. 4029–4034.



## Lower Bound for the DTSP with Neighborhoods Generalized Dubins Interval Problem

- In the DTSPN, we need to determine the **headings** and also the **waypoint locations**.
- The **Dubins Interval Problem (DIP)** is not sufficient to provide tight lower-bound.

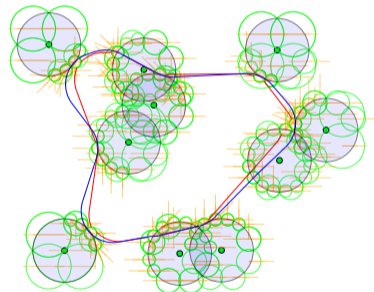
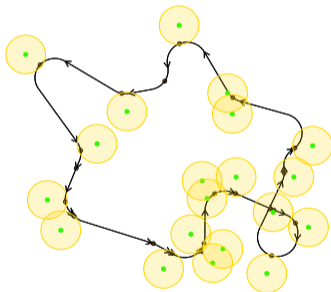

- **Generalized Dubins Interval Problem (GDIP)** can be utilized for the DTSPN similarly as the DIP for the DTSP.

Váňa and Faigl: *Optimal Solution of the Generalized Dubins Interval Problem*, RSS 2018, best student paper finalist.



# Generalized Dubins Interval Problem (GDIP)

- Determine the shortest Dubins maneuver connecting  $P_i$  and  $P_j$  given the angle intervals  $\theta_i \in [\theta_i^{\min}, \theta_i^{\max}]$  and  $\theta_j \in [\theta_j^{\min}, \theta_j^{\max}]$ .

## Full problem (GDIP)

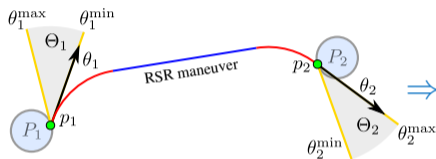

## One-side version (OS-GDIP)

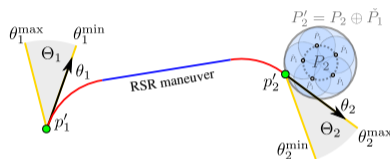

- Optimal solution** – Closed-form expressions for (1–6) and convex optimization (7).

### 1) S type

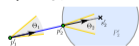

### 2) CS type



### 3) C\_psi type



### 7) CC\_psi type



### 4) CSC type



### 5) CSC\_bar type

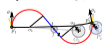

### 6) CC\_psi\_C type



Average computational time

Problem	Time [ $\mu\text{s}$ ]	Ratio
Dubins maneuver	0.4	1.0
DIP	1.1	3.0
GDIP	5.4	14.5

<https://github.com/comrob/gdip>

Váňa, P. and Faigl, J.: *Optimal Solution of the Generalized Dubins Interval Problem Finding the Shortest Curvature-constrained Path Through a Set of Regions*, *Autonomous Robots*, 44(7):1359-1376, 2020.



## GDIP-based Informed Sampling for the DTSPN

- Iterative refinement of the neighborhood samples and heading samples.

Resolution: 4

Gap: 69.3 %

Time: 0.079 s

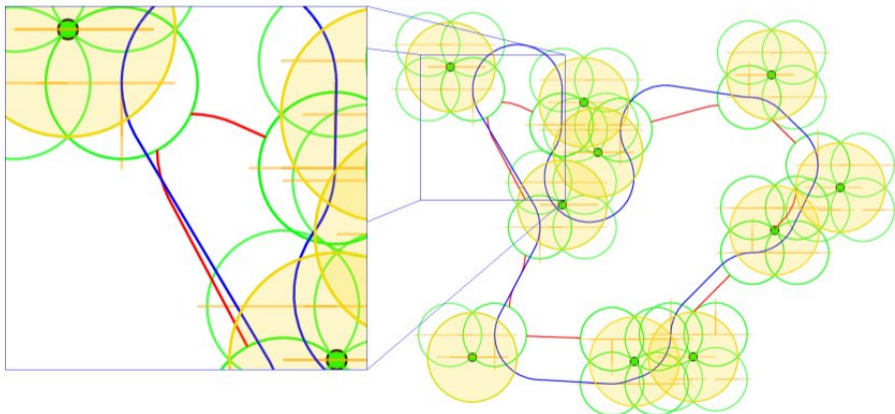

# GDIP-based Informed Sampling for the DTSPN

- Iterative refinement of the neighborhood samples and heading samples.

Resolution: 8

Gap: 39.4 %

Time: 0.211 s

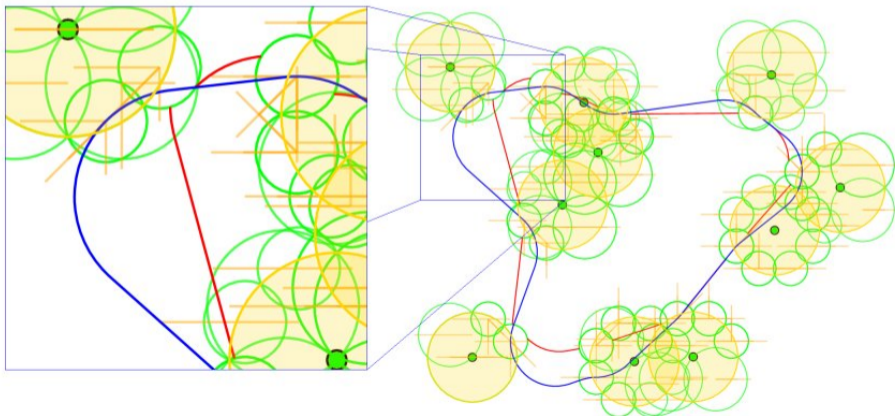



## GDIP-based Informed Sampling for the DTSPN

- Iterative refinement of the neighborhood samples and heading samples.

Resolution: 16

Gap: 19.9 %

Time: 0.552 s

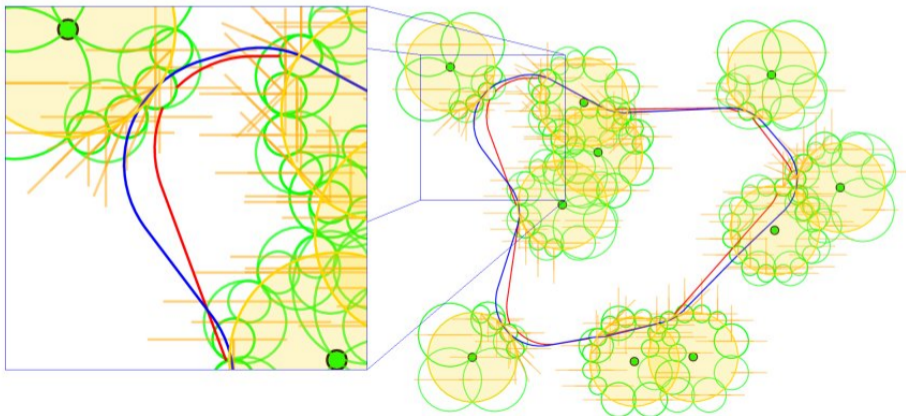

## GDIP-based Informed Sampling for the DTSPN

- Iterative refinement of the neighborhood samples and heading samples.

Resolution: 32

Gap: 10.7 %

Time: 1.292 s

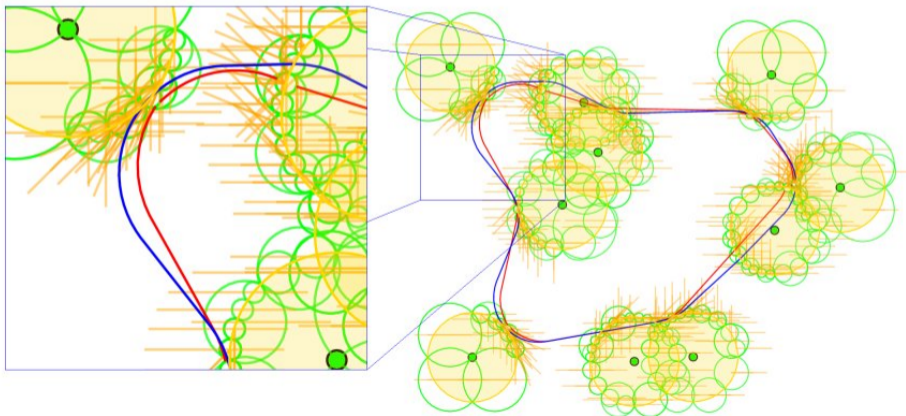

## GDIP-based Informed Sampling for the DTSPN

- Iterative refinement of the neighborhood samples and heading samples.

Resolution: 64

Gap: 5.3 %

Time: 3.183 s

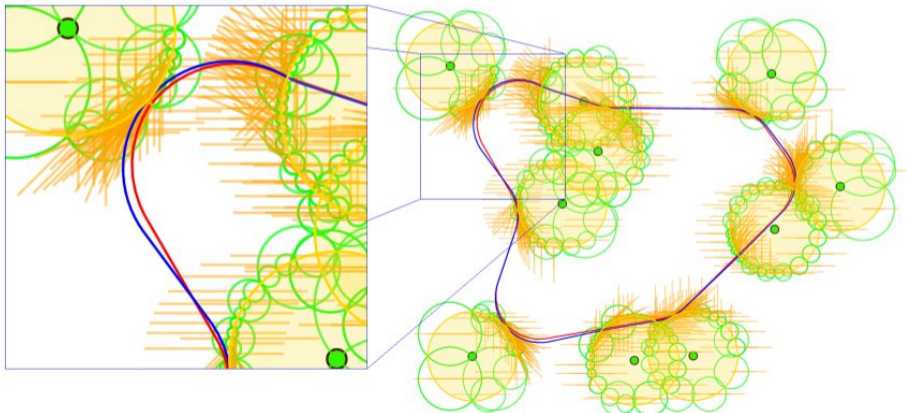

## GDIP-based Informed Sampling for the DTSPN

- Iterative refinement of the neighborhood samples and heading samples.

Resolution: 128

Gap: 2.6 %

Time: 8.994 s

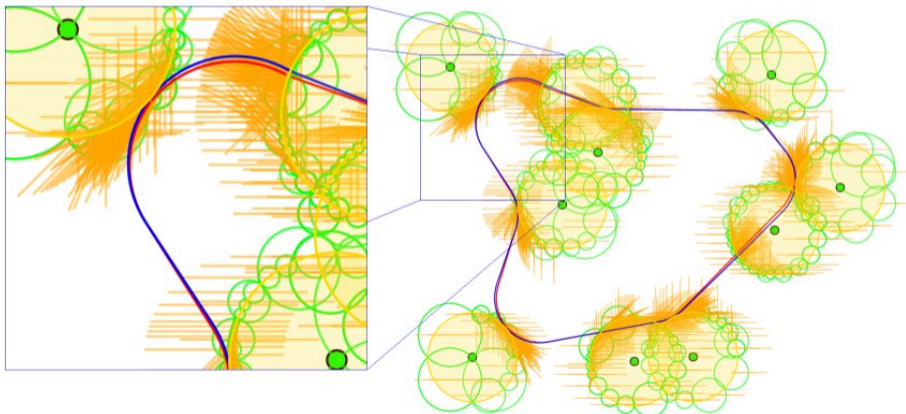

# GDIP-based Informed Sampling for the DTSPN

- Iterative refinement of the neighborhood samples and heading samples.

Resolution: 256

Gap: 1.3 %

Time: 33.474 s

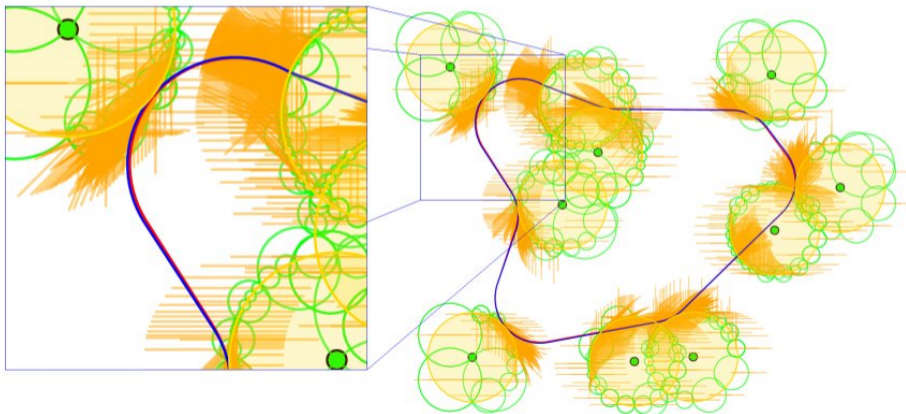

## DTSPN – Convergence to the Optimal Solution

- For a given sequence of visits to the target regions (locations).

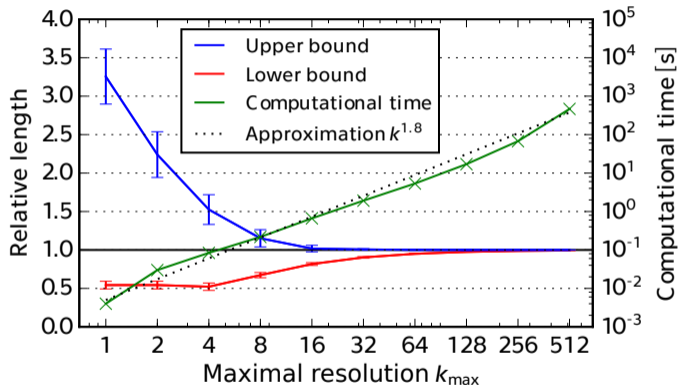
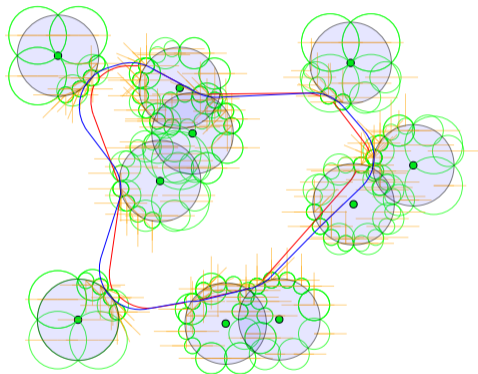

- The algorithm scales linearly with the number of locations.
- Complexity of the algorithm is approximately  $\mathcal{O}(nk^{1.8})$ .

<https://github.com/comrob/gdip>



# Outline

- Dubins Vehicle and Dubins Planning
- Dubins Touring Problem (DTP)
- Dubins Traveling Salesman Problem
- Dubins Traveling Salesman Problem with Neighborhoods
- **Dubins Orienteering Problem**
- Dubins Orienteering Problem with Neighborhoods
- Planning in 3D – Examples and Motivations



# Data Collection / Surveillance Planning with Travel Budget

- Visit the most important targets because of limited travel budget.
- The problem can be formulated as the **Orienteering Problem** with Dubins vehicle, a.k.a. **Dubins Orienteering Problem (DOP)**.

Robert Pěnička, Jan Faigl, Petr Váňa and Martin Saska, RA-L 2017

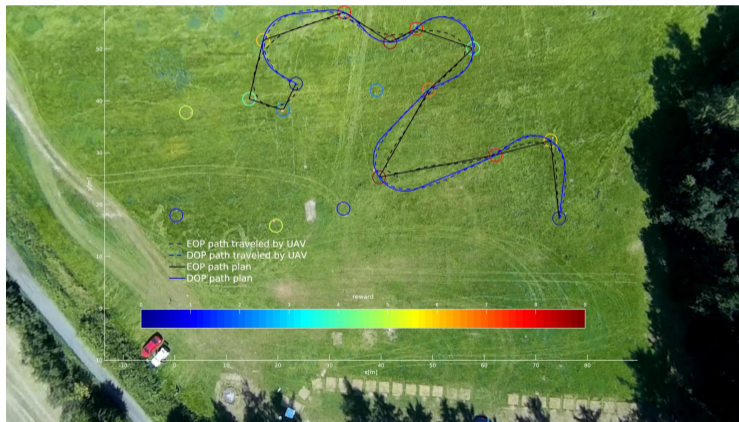

<http://mrs.felk.cvut.cz/icra17dop>





## Dubins Orienteering Problem

- Curvature-constrained data collection path respecting Dubins vehicle model with the minimal turning radius  $\rho$  and constant forward velocity  $v$ .
- The path is a sequence of waypoints  $q_i \in SE(2)$ ,  $q = (s, \theta)$ ,
- In addition to  $S_k, k, \Sigma$  (OP) determine headings  $\Theta = (\theta_{\sigma_1}, \dots, \theta_{\sigma_k})$  such that

$$\begin{aligned} & \text{maximize}_{k, S_k, \Sigma} && R = \sum_{i=1}^k r_{\sigma_i} \\ & \text{subject to} && \sum_{i=2}^k \mathcal{L}(q_{\sigma_{i-1}}, q_{\sigma_i}) \leq T_{\max}, \\ & && q_{\sigma_i} = (s_{\sigma_i}, \theta_{\sigma_i}), s_{\sigma_i} \in S, \theta_{\sigma_i} \in \mathbb{S}^1 \\ & && s_{\sigma_1} = s_1, s_{\sigma_k} = s_n \end{aligned}$$

The problem combines discrete combinatorial optimization (OP) with the continuous optimization for **determining the vehicle headings**.

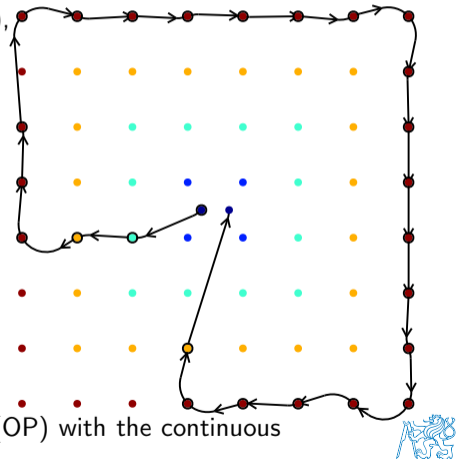

## Variable Neighborhood Search (VNS)

- **Variable Neighborhood Search (VNS)** is a general metaheuristic for combinatorial optimization (routing problems).

Hansen, P. and Mladenović, N. (2001): **Variable neighborhood search: Principles and applications**. European Journal of Operational Research.

- The VNS is based on **shake** and **local search** procedures.
  - **Shake** procedure aims to escape from local optima by changing the solution within the neighborhoods  $N_{1, \dots, k_{max}}$ . *The neighborhoods are particular operators.*
  - **Local search** procedure searches fully specific neighborhoods of the solution using  $l_{max}$  predefined operators.



## Variable Neighborhood Search (VNS) for the DOP

- The solution is the first  $k$  locations of the sequence of all target locations satisfying  $T_{\max}$ .

Sevкли Z., Sevilgen F.E.: *Variable Neighborhood Search for the Orienteering Problem*, SCIS, 2006.

- It is an improving heuristics, i.e., an initial solution has to be provided.
- A set of predefined neighborhoods are explored to find a better solution.
- Shake** – explores the configuration space and escape from a local minima using
  - Insert** – moves one random element;
  - Exchange** – exchanges two random elements.
- Local Search** – optimizes the solution using
  - Path insert** – moves a random sub-sequence;
  - Path exchange** – exchanges two random sub-sequences.
- Randomized VNS** – examines only  $n^2$  changes in the *Local Search* procedure in each iteration.

### Insert



### Exchange



### Path insert

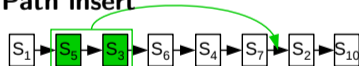

### Path exchange



# Evolution of the VNS Solution to the DOP

Initial solution



$T_{CPU} = 10.9$  s,  
 $\mathcal{L} = 79.6$ ,  $R = 960$

4710th iteration  
(4th improvement)

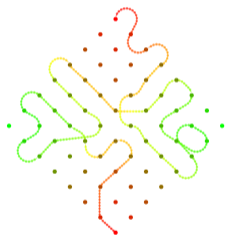

$T_{CPU} = 144.8$  s,  
 $\mathcal{L} = 79.7$ ,  $R = 990$

4790th iteration  
(12th improvement)



$T_{CPU} = 147.3$  s,  
 $\mathcal{L} = 79.3$ ,  $R = 1008$

5560th iteration  
(16th improvement)

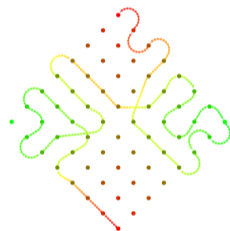

$T_{CPU} = 170.0$  s,  
 $\mathcal{L} = 79.1$ ,  $R = 1050$



# Possible Solutions of the Dubins Orienteering Problem

1. Solve the Euclidean OP (EOP) and then determine Dubins path.

*The final path may exceed the budget and the vehicle can miss the locations because of motion control.*

2. Directly solve the **Dubins Orienteering Problem (DOP)** such as

- Sample possible heading values and use Variable Neighborhood Search (VNS);  
Pěnička, R., Faigl, J., Váňa, P., and Saska, M.: *Dubins Orienteering Problem*, IEEE Robotics and Automation Letters, 2(2):1210–1217, 2017.
- Unsupervised learning based on Self-Organizing Maps (SOM);  
Faigl, J.: *Self-organizing map for orienteering problem with dubins vehicle*, Advances in Self-Organizing Maps, Learning Vector Quantization, Clustering and Data Visualization, 2017, pp. 125–132.

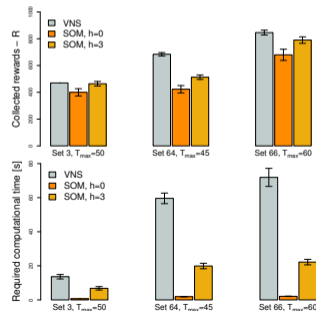
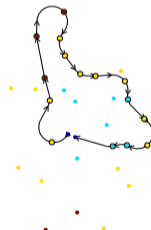
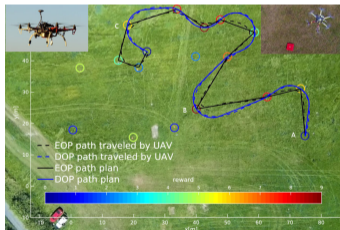

The VNS-based approach provides better solutions than the SOM-based solution, but it tends to be more demanding.



# Outline

- Dubins Vehicle and Dubins Planning
- Dubins Touring Problem (DTP)
- Dubins Traveling Salesman Problem
- Dubins Traveling Salesman Problem with Neighborhoods
- Dubins Orienteering Problem
- **Dubins Orienteering Problem with Neighborhoods**
- Planning in 3D – Examples and Motivations





# Variable Neighborhoods Search (VNS) for the DOPN

---

**Algorithm 3:** VNS based method for the DOPN
 

---

```

Input :  $S$  – Set of the target locations
Input :  $T_{\max}$  – Maximal allowed budget
Input :  $o$  – Initial number of position waypoints for each target
Input :  $m$  – Initial number of heading values for each waypoints
Input :  $r_i$  – Local waypoint improvement ratio
Input :  $l_{\max}$  – Maximal neighborhood number
Output:  $P$  – Found data collecting path
 $S_r \leftarrow \text{getReachableLocations}(S, T_{\max})$ 
 $P \leftarrow \text{createInitialPath}(S_r, T_{\max})$  // greedy
while Stopping condition is not met do
   $l \leftarrow 1$ 
  while  $l \leq l_{\max}$  do
     $P' \leftarrow \text{shake}(P, l)$ 
     $P'' \leftarrow \text{localSearch}(P', l, r_i)$ 
    if  $\mathcal{L}_d(P'') \leq T_{\max}$  and
       $[[R(P'') > R(P)] \text{ or } [R(P'') == (P) \text{ and } \mathcal{L}_d(P'') < \mathcal{L}_d(P)\mathcal{L}_d(P'')]]$ 
    then
       $P \leftarrow P''$ 
       $l \leftarrow 1$ 
    else
       $l \leftarrow l + 1$ 
    end
  end
end
  
```

---

The particular  $l$  for the individual operators of the **shake** procedure are:

- **Waypoint Shake** ( $l = 1$ );
- **Path Move** ( $l = 2$ );
- **Path Exchange** ( $l = 3$ ).

The **local search** procedure consists of three operators and the particular  $l$  for the individual operators of the **local search** procedure are:

- **Waypoint Improvement** ( $l = 1$ );
- **One Point Move** ( $l = 2$ );
- **One Point Exchange** ( $l = 3$ ).

Pěnička, R., Faigl, J., Saska, M., and Váňa, P.: *Data collection planning with non-zero sensing distance for a budget and curvature constrained unmanned aerial vehicle*, *Autonomous Robots*, 43(8):1937–1956, 2019.

Pěnička, R., Faigl, J., Váňa, P., and Saska, M.: *Dubins Orienteering Problem with Neighborhoods*, *International Conference on Unmanned Aircraft Systems (ICUAS)*, 2017, pp. 1555–1562.





# VNS for DOPN – Example of the Shake Operators

## Path Move

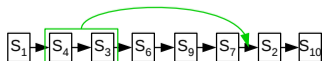
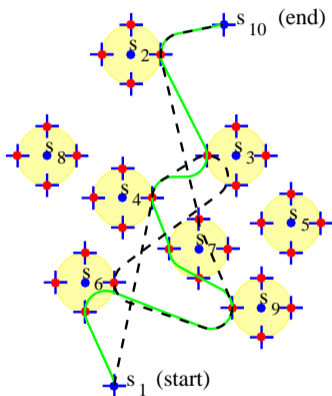

## Path Exchange

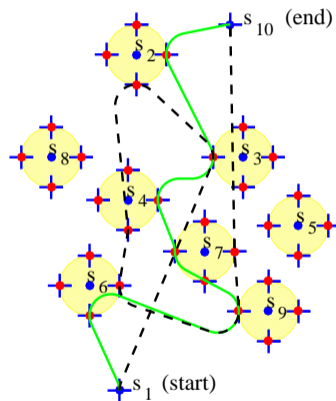



# DOPN – Example of Solution and Practical Deployment

- VNS-based solution of the DOPN.

Pěnička, R., Faigl, J., Váňa, P., and Saska, M.: *Dubins Orienteering Problem with Neighborhoods*, International Conference on Unmanned Aircraft Systems (ICUAS), 2017, pp. 1555–1562.

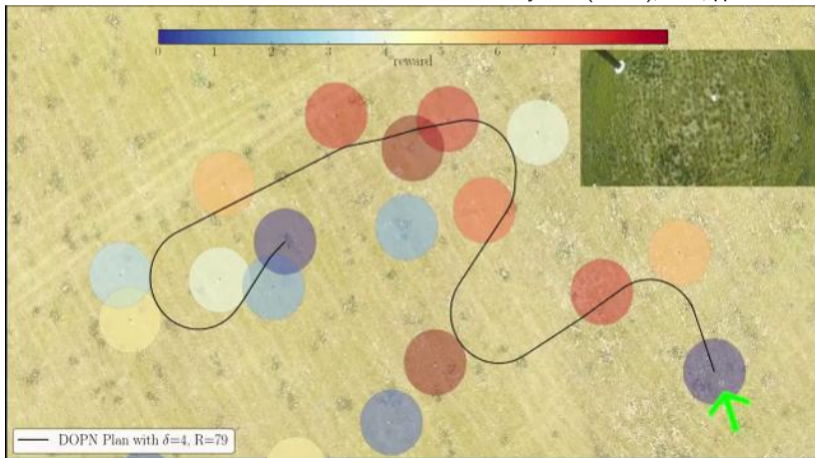

# Outline

- Dubins Vehicle and Dubins Planning
- Dubins Touring Problem (DTP)
- Dubins Traveling Salesman Problem
- Dubins Traveling Salesman Problem with Neighborhoods
- Dubins Orienteering Problem
- Dubins Orienteering Problem with Neighborhoods
- **Planning in 3D – Examples and Motivations**



## 3D Data Collection Planning with Dubins Airplane Model

- **Dubins Airplane model** describes the vehicle state

$q = (p, \theta, \psi)$ ,  $p \in \mathbb{R}^3$  and  $\theta, \psi \in \mathbb{S}^1$  as

$$\begin{bmatrix} \dot{x} \\ \dot{y} \\ \dot{z} \\ \dot{\theta} \end{bmatrix} = v \begin{bmatrix} \cos \theta \cdot \cos \psi \\ \sin \theta \cdot \cos \psi \\ \sin \psi \\ u_\theta \cdot \rho^{-1} \end{bmatrix}.$$

H. Chitsaz and S. M. LaValle: *Time-optimal paths for a Dubins airplane*, IEEE Conference on Decision and Control, 2007, pp. 2379–2384.

- Constant forward velocity  $v$ , the minimal turning radius  $\rho$ , and limited pitch angle, i.e.,  $\psi \in [\psi_{min}, \psi_{max}]$ .
- $u_\theta$  controls the vehicle heading,  $|u_\theta| \leq 1$ , and  $v$  is the forward velocity.
- Generation of the 3D trajectory is based on the 2D Dubins maneuver.
- If altitude changes are too high, additional helix segments are inserted.

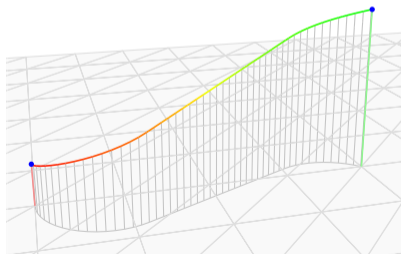
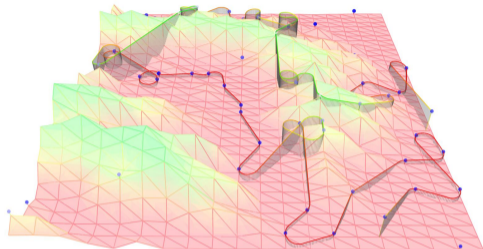

## The DTSPN in 3D

- Using the same principles as for the DTSPN in 2D, we can generalize the approaches for 3D planning using the Dubins Airplane model instead of simple Dubins vehicle.
- The regions can be generalized to 3D and the problem can be addressed by decoupled or sampling-based approaches, i.e., using GATSP formulation.
- In the case of LIO, we need a parametrization of the possible waypoint location, such as point on the object boundary.

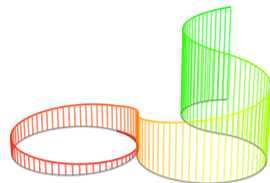

CCC maneuver

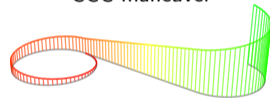

CSC maneuver

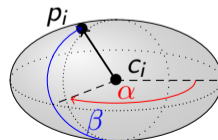
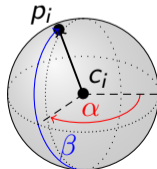
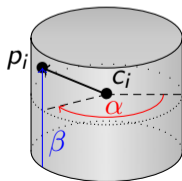

## Solutions of the 3D-DTSPN

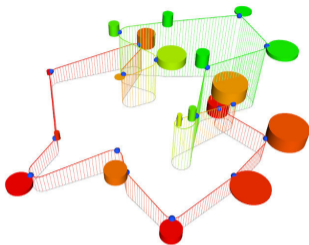

---

### Algorithm 4: LIO-based Solver for 3D-DTSPN

---

**Data:** Regions  $\mathcal{R}$

**Result:** Solution represented by  $Q$  and  $\Sigma$

$\Sigma \leftarrow \text{getInitialSequence}(\mathcal{R});$

$Q \leftarrow \text{getInitialSolution}(\mathcal{R}, \Sigma);$

**while** *terminal condition* **do**

$Q \leftarrow \text{optimizeHeadings}(Q, \mathcal{R}, \Sigma);$

$Q \leftarrow \text{optimizeAlpha}(Q, \mathcal{R}, \Sigma);$

$Q \leftarrow \text{optimizeBeta}(Q, \mathcal{R}, \Sigma);$

**end**

**return**  $Q, \Sigma;$

---

- Solutions based on LIO (ETSP+LIO), TSP with the travel cost according to Dubins Airplane Model (DAM-TSP+LIO), and sampling-based approach with transformation of the GTSP to the ATSP solved by LKH.

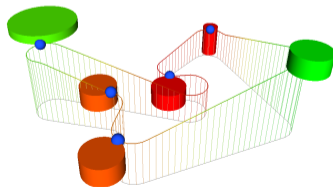
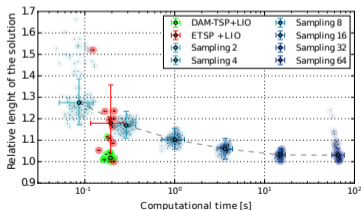

Váňa, P., Faigl, J., Sláma, J., and Pěnička, R.: *Data collection planning with Dubins airplane model and limited travel budget* European Conference on Mobile Robots (ECMR), 2017.



## 3D Surveillance Planning

- Parametrization of smooth 3D multi-goal trajectory as a sequence of Bézier curves.
- Unsupervised learning for the TSPN can be generalized for such trajectories.
- During the solution of the sequencing part of the problem, we can determine a velocity profile along the curve and compute the so-called *Travel Time Estimation* (TTE).
- Bézier curves better fit the limits of the multi-rotor UAVs that are limited by the maximal accelerations and velocities rather than minimal turning radius as for Dubins vehicle.

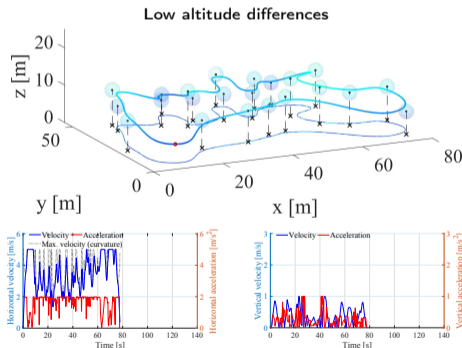

Faigl, J. and Váňa, P.: *Surveillance Planning With Bézier Curves*, IEEE Robotics and Automation Letters, 3(2):750–757, 2018.

- Low altitude differences saturate horizontal velocity while high altitudes changes saturate vertical velocity.

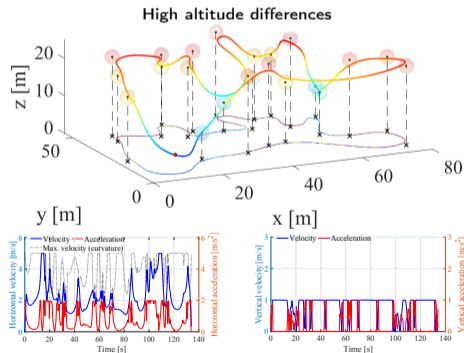



## Multi-Vehicle Multi-Goal Planning with Limited Travel Budget – Curvature-Constrained Team Orienteering Problem (with Neighborhoods)

- Operational time of multi-rotor aerial vehicles is limited and only a subset of locations can be visited.
- Planning multi-goal trajectories as a sequence of Bézier curves.

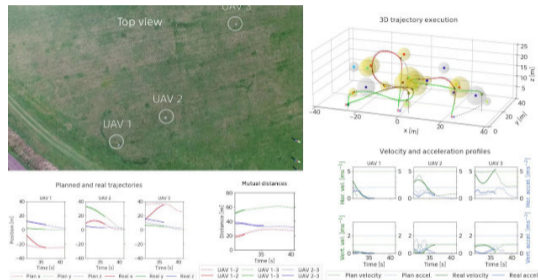
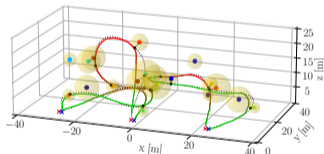

Orienteering Problem with Bézier curves: Non-crossing field experiment with 3 multi-rotor drones

- Targets are missed in a case of colliding trajectories, because of local collision avoidance and optimal trajectory following.
- There is a practical need to include coordination in multi-vehicle multi-goal trajectory planning.

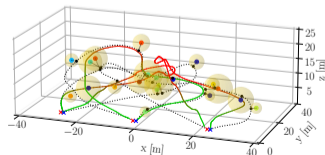

Faigl, J., Váňa, P., and Pěnička, R.: *Multi-Vehicle Close Enough Orienteering Problem with Bézier Curves for Multi-Rotor Aerial Vehicles*. ICRA 2019, pp. 3039–3044.



# Summary of the Lecture



# Summary

- Data collection planning with curvature-constrained paths/trajectories
  - The **Traveling Salesman Problem (TSP)** and **Orienteering Problem (OP)** with Dubins Vehicle, i.e., **DTSP** and **DOP**.
  - It is a combination of the combinatorial and continuous (determining optimal headings) optimization.
  - The continuous part can be solved using **Dubins Touring Problem (DTP)**.
  - Using a solution of the **Dubins Interval Problem (DIP)** we can establish **tight lower bound** of the DTP and DTSP with a particular sequence of visits.
  - The problems can be further extended to **DTSP with Neighborhoods (DTSPN)** and **OP with Neighborhoods (DOPN)**, and its **Close Enough** variants.
- The key ideas of the presented problems and approaches are as follows.
  - Consider proper assumptions that fits the original problem being solved.
    - Suitability of the vehicle model, requirements on the solution quality, and benefit of optimal or computationally demanding solutions.
  - Employing lower bound based on “a bit different problem” such as the **DIP** and **GDIP**, to find high quality solutions, even using decoupled approaches.
  - Challenging problems with continuous optimization can be addressed by decoupled and sampling-based approaches.
    - Be aware that the optimal solutions found for discretized problems, e.g., using ILP or combinatorial solvers, are not optimal solutions of the original (continuous) problem!



## Topics Discussed

- Dubins vehicles and planning – Dubins maneuvers
- **Dubins Interval Problem (DIP)** (lower bound estimation to the DTP, DTSP)
- **Dubins Touring Problem (DTP)**
- Dubins Traveling Salesman Problem (DTSP) and Dubins Traveling Salesman with Neighborhoods (DTSPN)
  - Decoupled approaches – Alternating Algorithm
  - Sampling-based approaches – GATSP
- **Generalized Dubins Interval Problem (GDIP)** (lower bound estimation to the DTSPN)
- Dubins Orienteering Problem (OP) and Dubins Orienteering Problem with Neighborhoods (DOPN)
- Data collection and surveillance planning in 3D
  
- **Next: Sampling-based motion planning**

