



**OPPA European Social Fund
Prague & EU: We invest in your future.**



DCGI

DEPARTMENT OF COMPUTER GRAPHICS AND INTERACTION

CONVEX HULL IN 3 DIMENSIONS

PETR FELKEL

FEL CTU PRAGUE

felkel@fel.cvut.cz

<https://cw.felk.cvut.cz/doku.php/courses/a4m39vg/start>

Based on [Berg], [Preparata], [Rourke] and [Boissonnat]

Version from 8.11.2012

Talk overview

- Lower bounds for convex hull in 2D and 3D
- Other criteria for CH algorithm classification
- Recapitulation of CH algorithms
- Terminology refresh
- Convex hull in 3D
 - Terminology
 - Algorithms
 - Gift wrapping
 - D&C Merge
 - Randomized Incremental

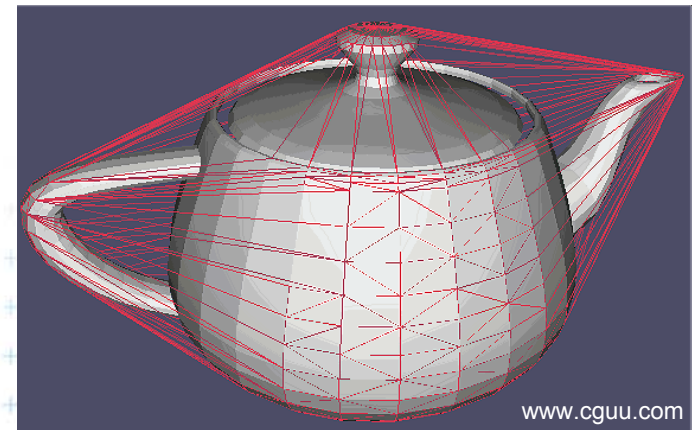

Lower bounds for Convex hull

- $O(n \log n)$ in E^2, E^3
- $O(n h)$, where h is number of CH facets
– output sensitive algs.
- $O(n)$ for sorted points and for polygon
- $O(\log n)$ for new point insertion in online algs.



Other criteria for CH algorithm classification

- Optimality – depends on data order (or distribution)
 - In worst case \times In expected case
- Output sensitivity – depends on the result
- Extendable to higher dimensions?
- Off-line versus on-line
 - Off-line – all points available, preprocessing for search speedup
 - On-line – stream of points, new point p_i on demand, just one new point at a time, CH valid for $\{p_1, p_2, \dots, p_r\}$
 - Real-time – points come as they “want”
(not faster than optimal constant $O(\log n)$ inter-arrival delay)
- Parallelizable
- Dynamic – points can be deleted

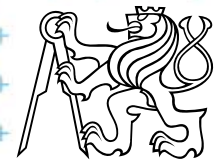

Why to search other convex hull algorithms?

- Graham scan

$O(n \log n)$ time and $O(n)$ space is

- optimal in worst case
- not optimal in average case (not output sensitive)
- only 2D
- off-line
- serial (not parallel)
- not dynamic

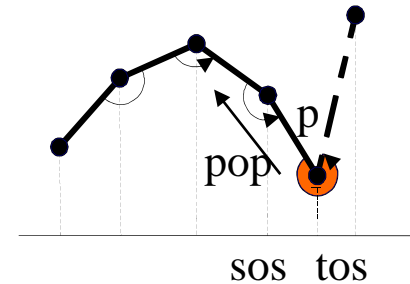

$O(n)$ for polygon (will be discussed in seminar [9])



Jarvis March – Gift wrapping

- $O(hn)$ time and $O(n)$ space is
 - not optimal in worst case $O(n^2)$
 - may be optimal if $h \ll n$ (output sensitive)
 - 3D or higher dimensions (see later)
 - off-line
 - serial (not parallel)
 - not dynamic

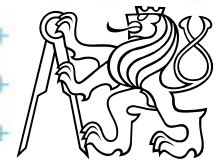
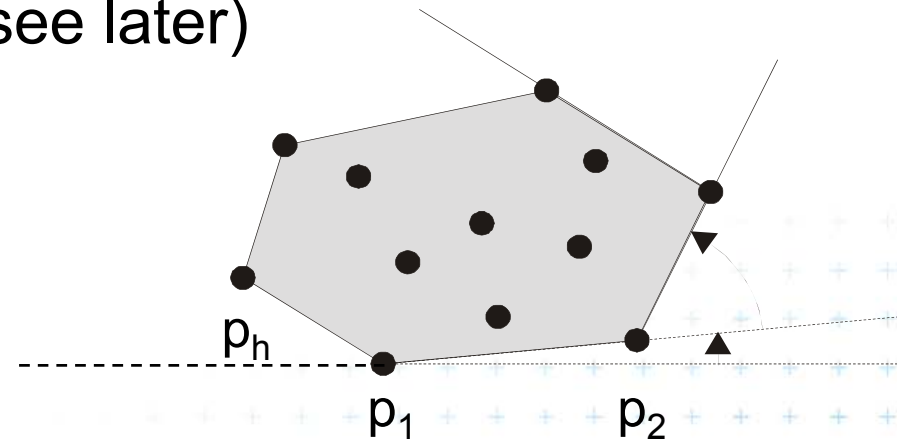

Divide & Conquer

- $O(n \log n)$ time and $O(n)$ space is
 - optimal in worst case (in 2D or 3D)
 - not optimal in average case (not output sensitive)
 - 2D or 3D (circular ordering), in higher dims not optimal
 - off-line
 - Version with sorting (the presented one) – serial
 - Parallel for overlapping merged hulls (see Chapter 3.3.5 in Preparata for details)
 - not dynamic

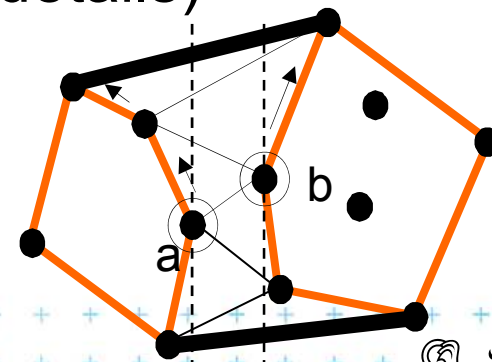

Quick hull

- $O(n \log n)$ expected time, $O(n^2)$ the worst case and $O(n)$ space *in 2D* is
 - not optimal in worst case $O(n^2)$
 - optimal if uniform distribution then $h \ll n$ (output sensitive)
 - 2D, or higher dimensions [see <http://www.qhull.org/>]
 - off-line
 - serial (not parallel)
 - not dynamic

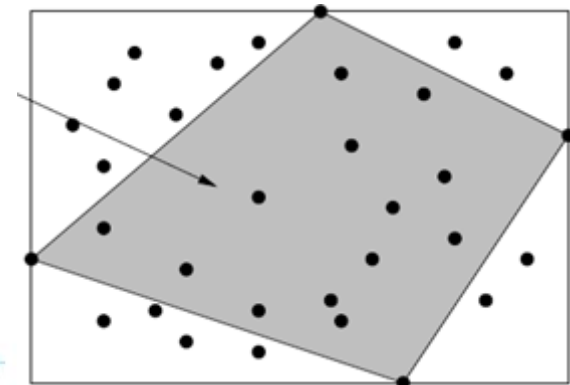

[Mount]

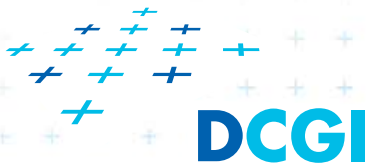

Chan

- $O(n \log h)$ time and $O(n)$ space is
 - optimal for h points on convex hull (output sensitive)
 - 2D and 3D --- gift wrapping
 - off-line
 - Serial (not parallel)
 - not dynamic



Preparata's on-line algorithm

- New point p is tested
 - Inside → ignored
 - Outside → added to hull
 - Find left and right **supporting lines** (touch at supporting points)
 - Remove points between supporting points
 - Add p to CH between supporting lines

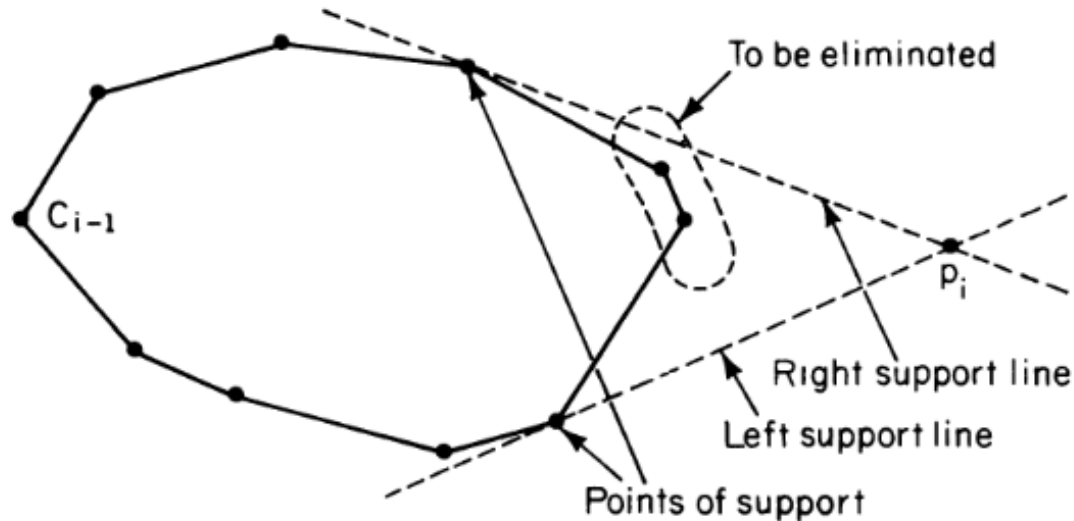

[Preparata]

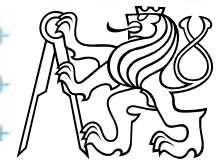

Overmars and van Leeuwen

- Allow dynamic CH (on-line insert & delete)
- Manage special tree with all intermediate CHs
- Will be discussed on seminar [7]

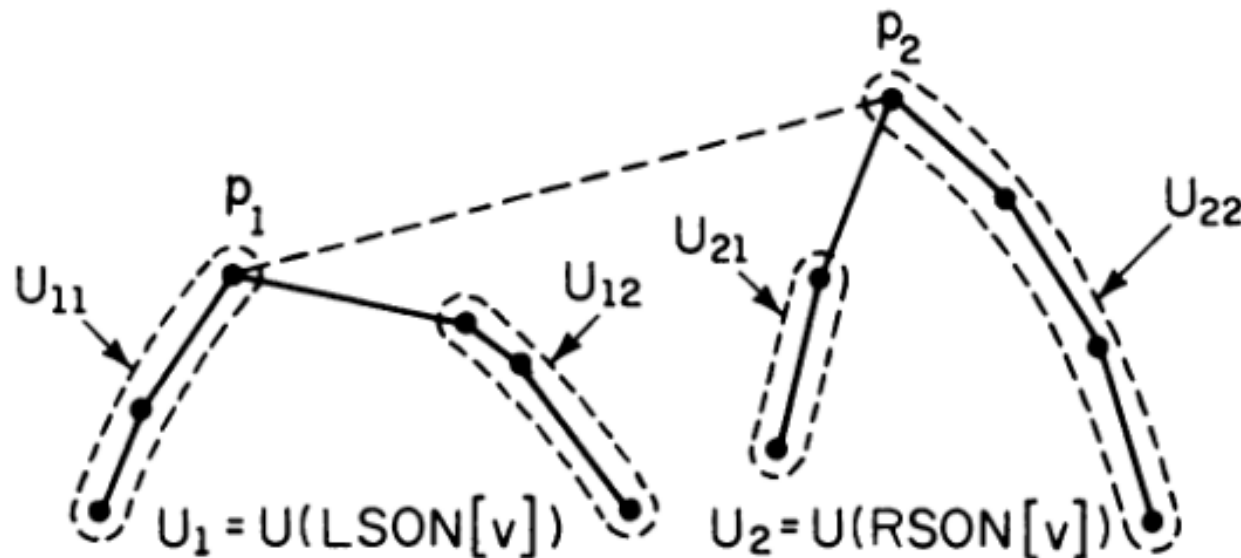

[Preparata]

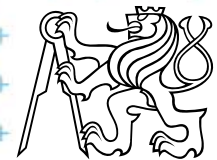

Convex hull in 3D

- Terminology
- Algorithms
 1. Gift wrapping
 2. D&C Merge
 3. Randomized Incremental



Terminology

- **Polytope** (d-polytope)
= convex hull of finite set of points in E^d

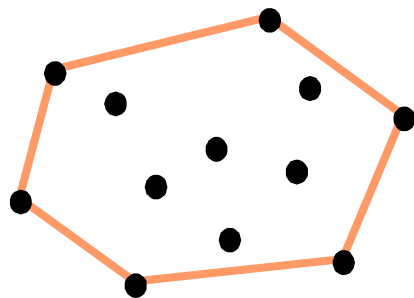

2-polytop

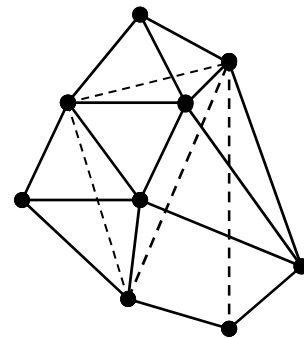

3-polytop

- **Simplex** (k-simplex, d-simplex)
= CH of $k + 1$ affine independent points



1-simplex

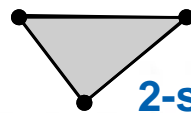

2-simplex

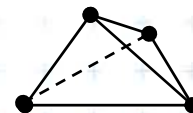

3-simplex

= “Special” Polytope with all the points are on the CH



Terminology (2)

- **Affine combination**

= linear combination of the points $\{p_1, p_2, \dots, p_n\}$
whose coefficients $\{\lambda_1, \lambda_2, \dots, \lambda_n\}$ **sum to 1**, and $\lambda_i \in \mathbb{R}$

$$\sum_{i=1}^n \lambda_i p_i$$

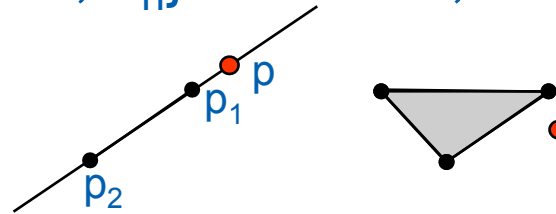

- **Affine independent points**

= no one point can be expressed as affine combination of the others



- **Convex combination**

= linear combination of the points $\{p_1, p_2, \dots, p_n\}$
whose coefficients $\{\lambda_1, \lambda_2, \dots, \lambda_n\}$ **sum to 1**, and $\lambda_i \in \mathbb{R}^+_0$
(i.e., $\forall i \in \{1, \dots, k\}, \lambda_i \geq 0$)

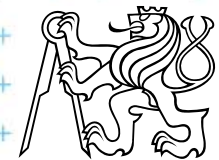

Terminology (3)

- Any $(d-1)$ -dimensional hyperplane h divides the space into (open) halfspaces h^+ and h^- , so that $E^n = h^+ \cup h \cup h^-$
- Def: $\overline{h^+} = h^+ \cup h$, $\overline{h^-} = h^- \cup h$ (closed halfspaces)
- Hyperplane supports a polytope P (Supporting hyperplane)
 - if $h \cap P$ is not empty and
 - if P is entirely contained within either $\overline{h^+}$ or $\overline{h^-}$

In 2D:

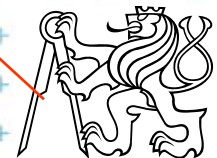
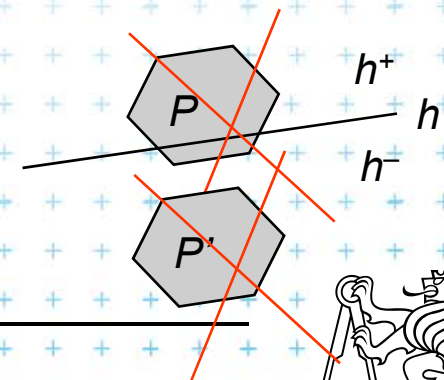
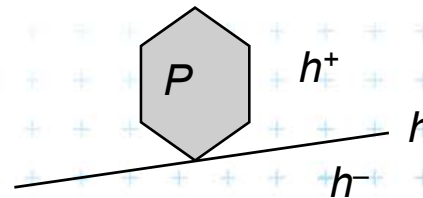
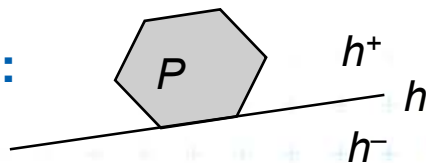

Faces and facets

- **Face** of the polytope
= Intersection of polytope P with a supporting hyperplane h
 - Faces are convex polytopes of dimension d ranging from 0 to $d - 1$
 - 0-face = **vertex**
 - 1-face = **edge**
 - $(d - 1)$ -face = **facet**

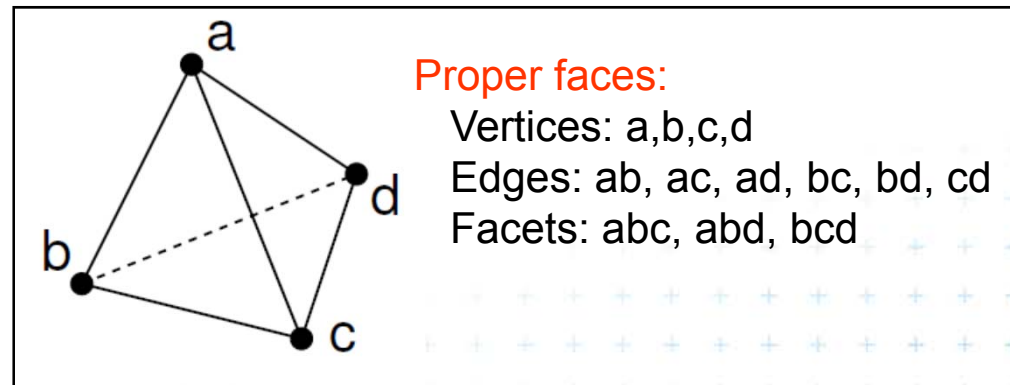

In 3D we often say *face*, but it means correctly a **facet**



Proper faces

- Proper faces

= Faces of dimension d ranging from 0 to $d - 1$

- Improper faces

= proper faces + two additional faces:

- $\{\}$ = Empty set = face of dimension -1
- Entire polytope = face of dimension d

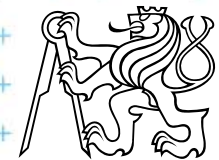
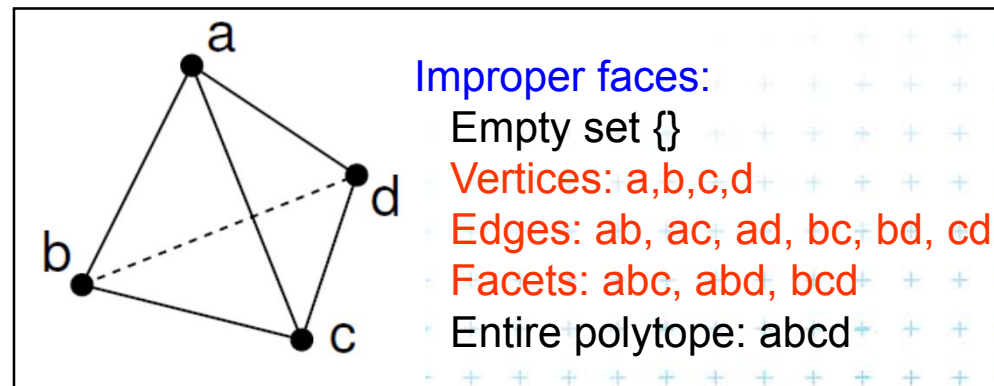

Incident graph

- Stores **topology of the polytope**
- Ex: 3-simplex:

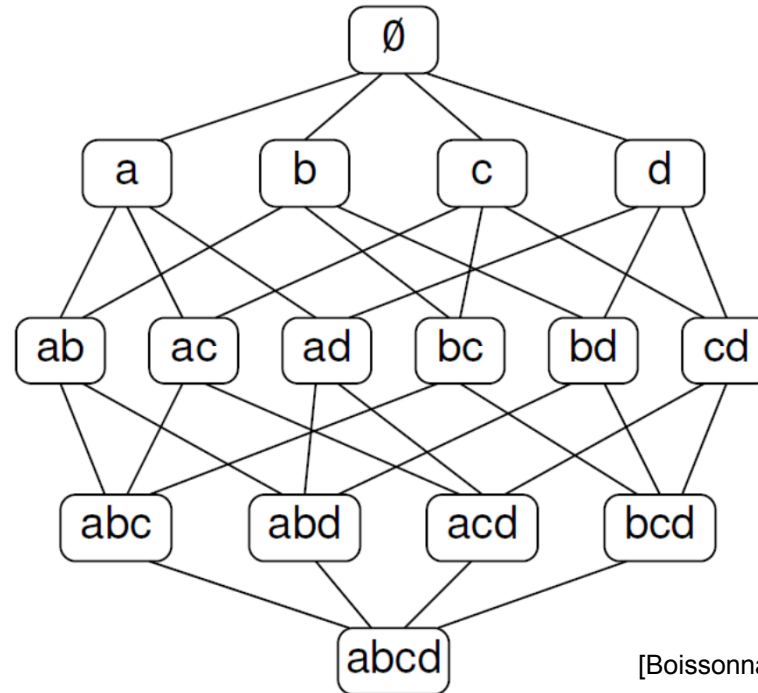
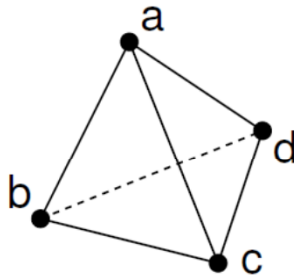

[Boissonnat]

Dimension

-1

0

1

2

3

- D-simplex is very regular face structure:
 - 1-face for each pair of vertices
 - 2-face for each triple of vertices



Facts about polytopes

- Boundary of polytope is *union of its proper faces*
- Polytope has *finite number of faces (next slide)*.
Each face is a polytope
- Polytope is *convex hull of its vertices (the def)*
(its bounded)
- Polytope is the *intersection of finite number of closed halfspaces $\overline{h^+}$*
(conversely not: intersection of closed halfspaces may be unbounded => called polyhedron or unbounded polytope)



Number of faces on a d-simplex

- Number of ***j*-dimensional faces** on a ***d*-simplex**
= number of ***(j+1)*-element subsets** from domain of size ***(d+1)***

$$\binom{d+1}{j+1} = \frac{(d+1)!}{(j+1)!(d-j)!}$$

- Ex.: Tetrahedron = 3-simplex:

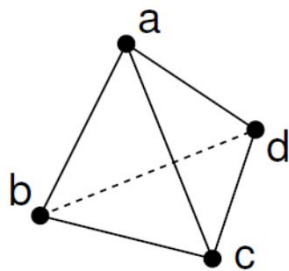

- facets (2-dim. faces) $\binom{3+1}{2+1} = \frac{4!}{3!1!} = 4$

- edges (1-dim. faces) $\binom{3+1}{1+1} = \frac{4!}{2!2!} = 6$

- vertices (0-dim faces) $\binom{3+1}{0+1} = \frac{4!}{1!3!} = 4$

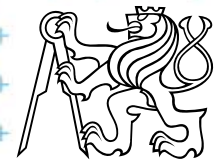

Complexity of 3D convex hull is $O(n)$

- The worst case complexity \rightarrow if all n points on CH
 \Rightarrow use 3-simplex for complexity derivation

1. has all points on its surface – on the Convex Hull
2. has usually more edges E and faces F than 3-polytope
3. has triangular facets, each generates 3 edges, shared by 2 triangles $\Rightarrow 3F = 2E$ 2-manifold

- $V - E + F = 2$... Euler formula for $V = n$ points

$$V - E + 2E/3 = 2$$

$$V - 2 = E / 3$$

$$E = 3V - 6, \quad V = n$$

$$E = O(n)$$

$$F = 2E / 3$$

$$F = 2V - 4$$

$$F = O(n)$$

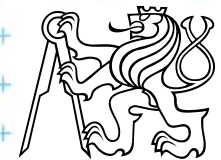
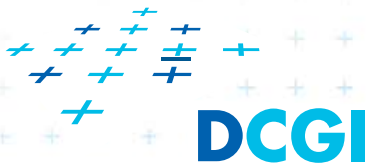

1. Gift wrapping in higher dimensions

- First known algorithm for n -dimensions (1970)
- Direct extension of 2D alg.
- Complexity $O(nF)$
 - F is number of CH facets
 - Algorithm is output sensitive
 - Details on seminar, assignment [10]

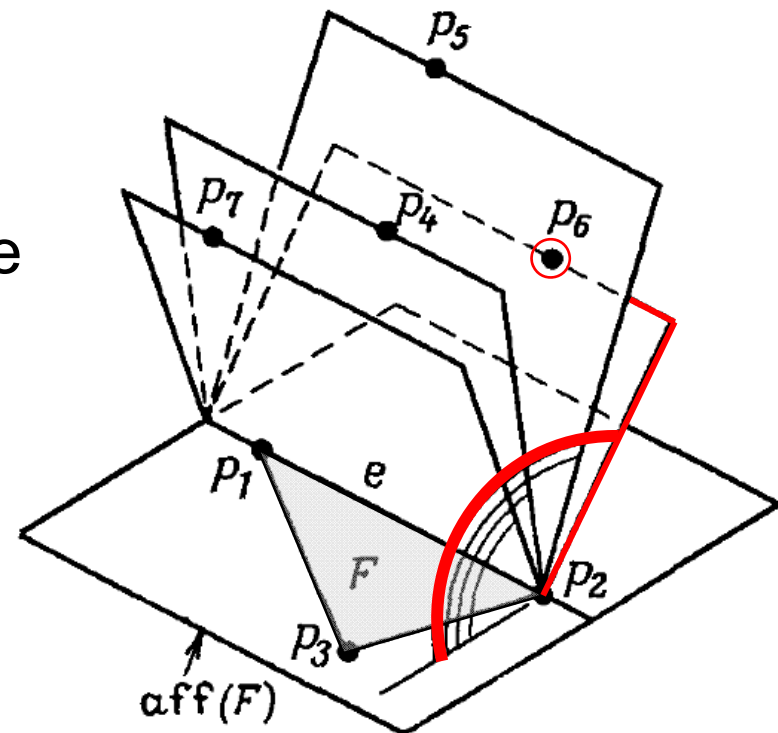

[Preparata]



The angle comparison [Preparata 3.4.1]

Cotangent of the angle φ_k between halfplanes F and ep_k
 $= - |UP_2| / |UV|$, where $|UP_2| = \mathbf{v}_k \cdot \mathbf{a}$ and $|UV| = \mathbf{v}_k \cdot \mathbf{n}$

For each P_k compute $\varphi_k = \text{arcctan}(-\mathbf{v}_k \cdot \mathbf{a} / \mathbf{v}_k \cdot \mathbf{n})$,

The angle is $\max \varphi_k$

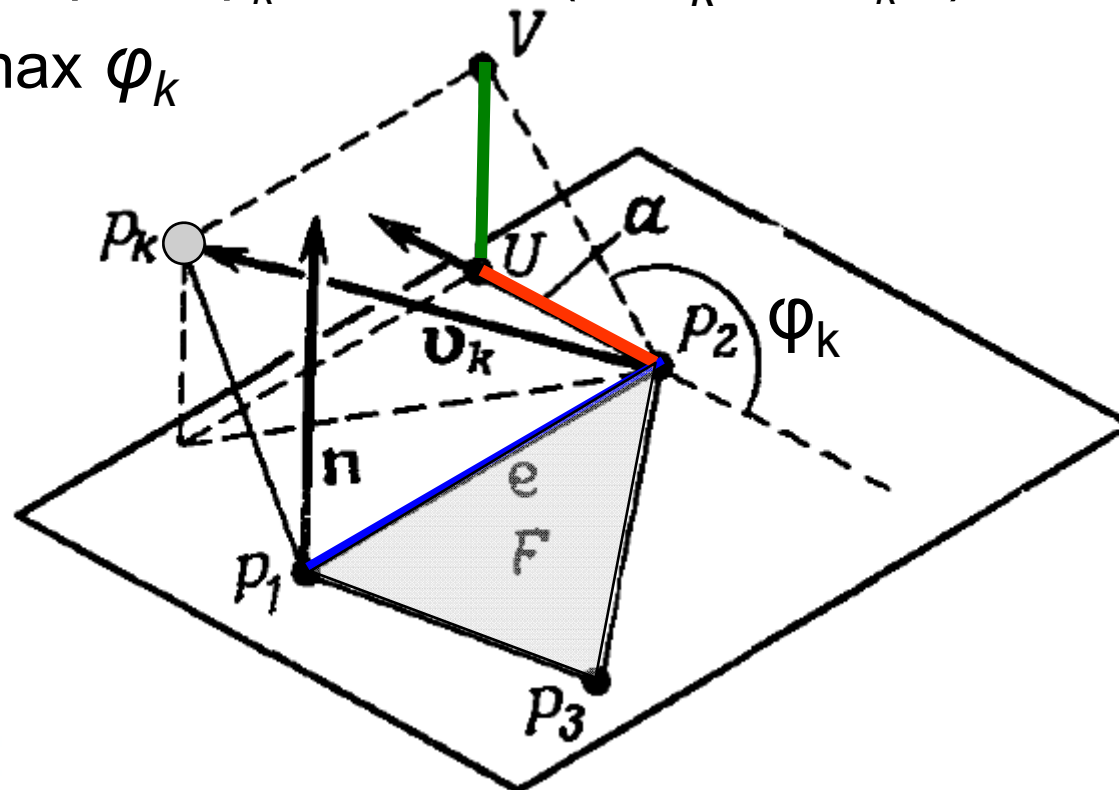

[Preparata]

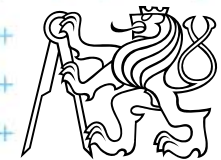

2. Divide & conquer 3D convex hull [Preparata, Hong77]

- Sort points in x-coord
- Recursively split, construct CH, merge
- Merge takes $O(n) \Rightarrow O(n \log n)$ total time

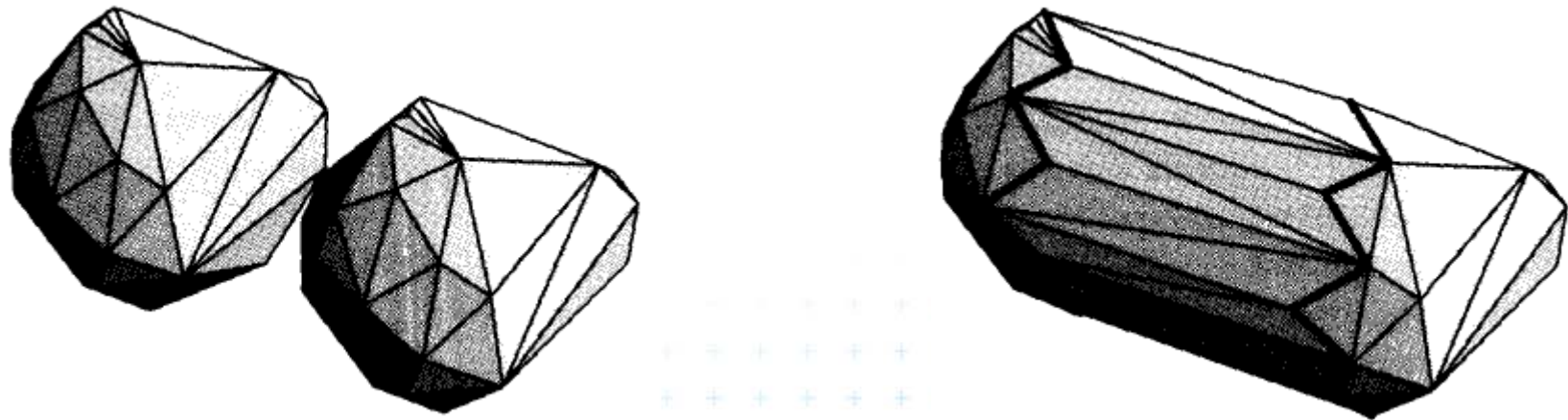

[Rourke]

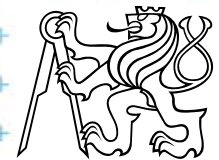

Divide & conquer 3D convex hull

[Preparata, Hong 77]

- Merge(C_1 with C_2) uses gift wrapping
 - Gift wrap plane around edge e – find new point p on C_1 or on C_2 (neighbor of a or b)
 - Search just the CW or CCW neighbors around a, b

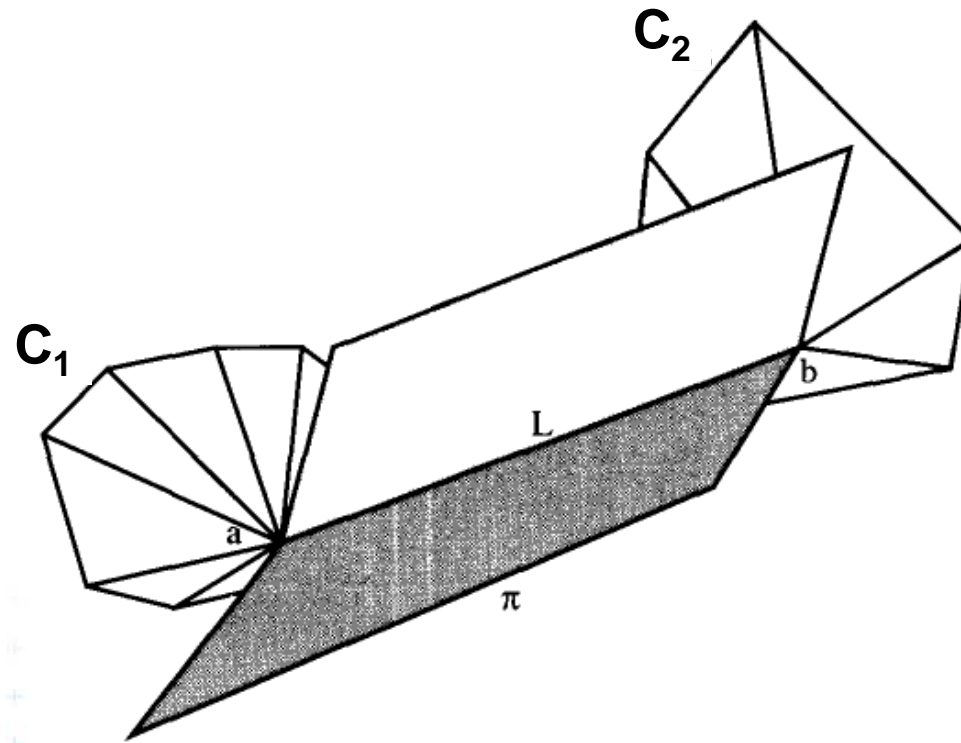

[Rourke]

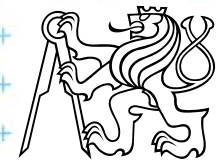

Divide & conquer 3D convex hull

[Preparata, Hong 77]

- Performance $O(n \log n)$ rely on circular ordering

- In 2D: Ordering of points around CH
- In 3D: Ordering of vertices around 2-polytop C_0 (vertices on intersection of new CH edges with separating plane H_0) [ordering around horizon of C_1 and C_2 does not exist, both horizons may be non-convex and even not simple polygons]

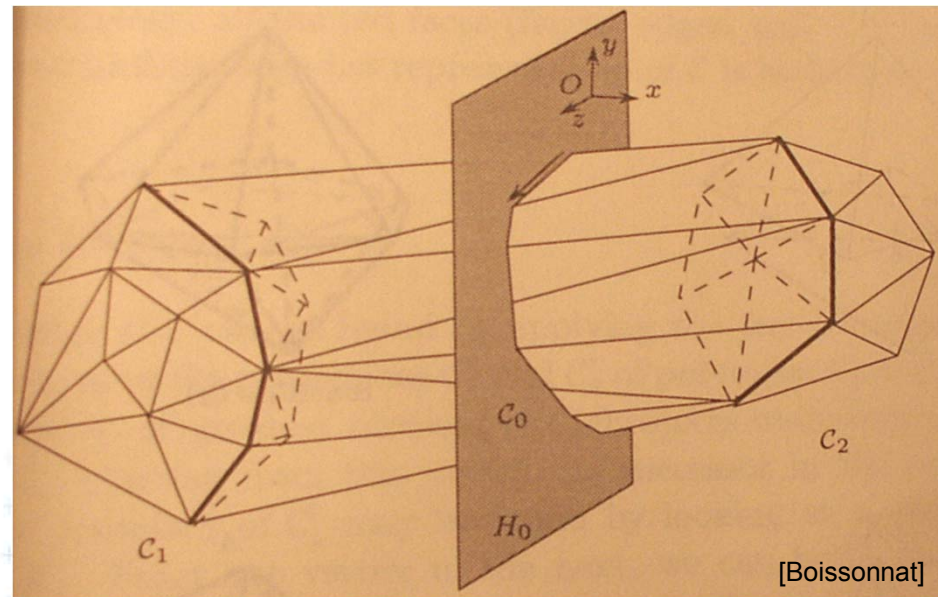

- In $\geq 4D$: Such ordering does not exist

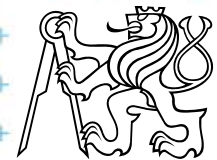

Divide & conquer 3D convex hull

[Preparata, Hong 77]

Merge(C_1 with C_2)

- Find the **first CH edge** L connecting C_1 with C_2
- $e = L$
- While not back at L *do*
 - store e to C
 - Gift wrap plane around edge e – find **new point** P on C_1 or on C_2 (neighbor of a or b)
 - $e =$ **new edge** to just found end-point P
 - Store **new triangle** eP to C
- Discard hidden faces inside CH from C
- Report **merged convex hull** C

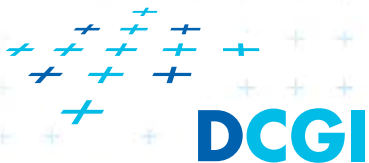

Divide & conquer 3D convex hull

[Preparata, Hong 77]

■ Problem of gift wrapping [Edelsbrunner 88]

- The edges on horizon do not form simple circle but a “barbell” 0,2,4,0,1,3,5,1

Do not stop here! ↑

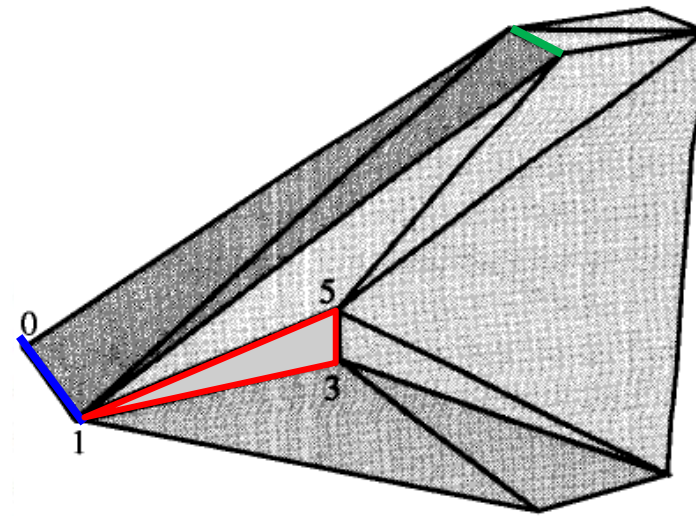
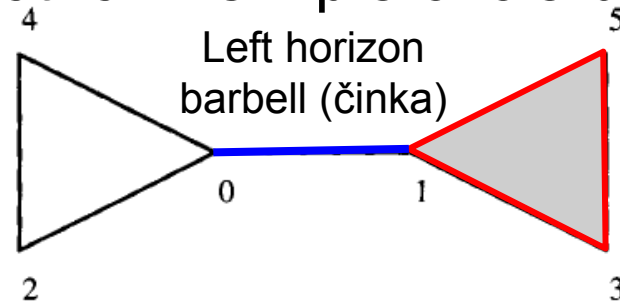
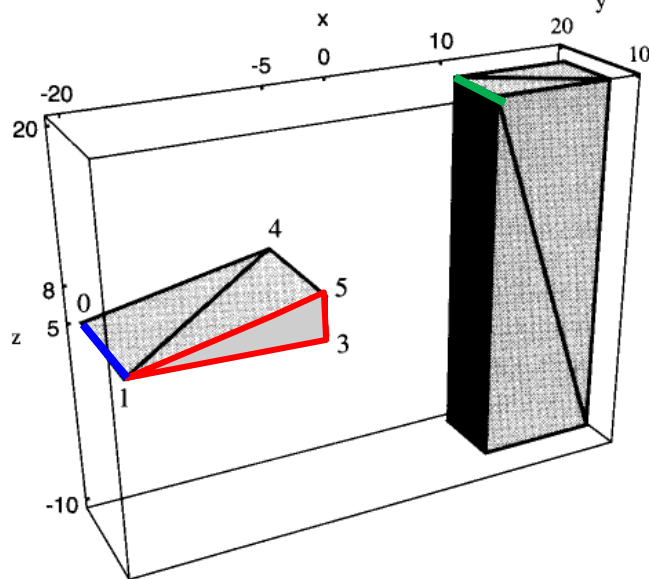

[Berg]

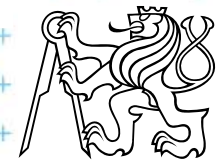

3. Randomized incremental alg. principle

1. Create tetrahedron (smallest CH in 3D)

- Take 2 points p_1 and p_2
- Search the 3rd point not lying on line p_1p_2
- Search the 4th point not lying in plane $p_1p_2p_3$...if not found, use 2D CH

2. Perform random permutation of remaining points $\{p_5, \dots, p_n\}$

3. For p_r in $\{p_5, \dots, p_n\}$ do add point p_r to $CH(P_{r-1})$

Notation: for $r \geq 1$ let $P_r = \{p_1, \dots, p_r\}$ is set of already processed pts

- If p_r lies **inside** or **on the boundary** of $CH(P_{r-1})$ then do nothing
- If p_r lies **outside** of $CH(P_{r-1})$ then
 - find and remove visible faces
 - create new faces (triangles) connecting p_r with lines of horizon

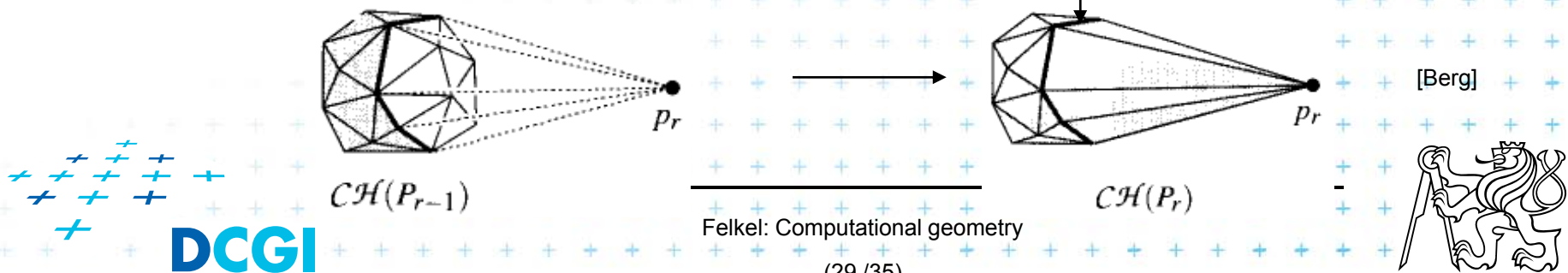

Conflict graph

- Stores unprocessed points with facets of CH they see

- Bipartite graph

points $p_t, t > r$... unprocessed points

facets of $CH(P_r)$... facets of convex hull

conflict arcs ... conflict, as visible facets cannot be in CH

- Maintains sets:

$P_{\text{conflict}}(f)$... points, that see f

$F_{\text{conflict}}(p_r)$... facets visible from p_r
(visible region – deleted after insertion of p_r)

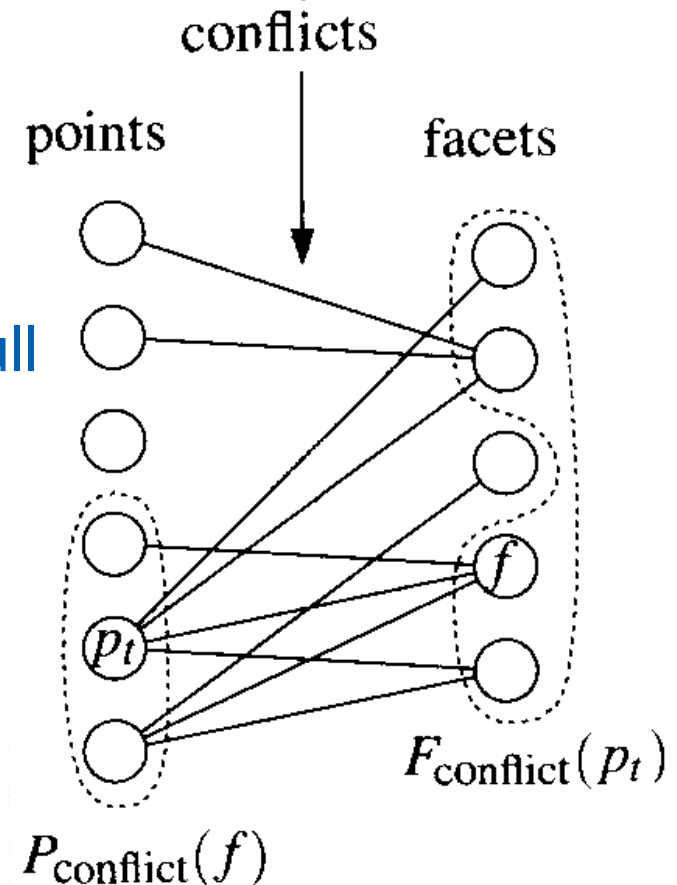

[Berg]



Visibility between point and face

- Face f is **visible** from a point p if that point lies in the open half-space on the other side of h_f than the polytope

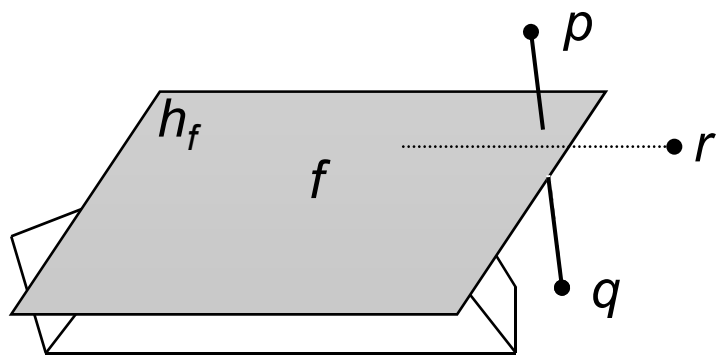

f is **visible** from p (p is above the plane)

f is **not visible** from r lying in the plane of f
(this case will be discussed next)

f is **not visible** from q

$p \in P_{\text{conflict}}(f)$, p is among the points that see the face f
 $f \in F_{\text{conflict}}(p)$ f is among the faces that visible from point p

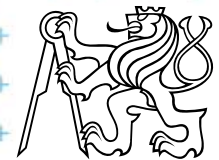

New triangles to horizon

- **Horizon** = edges e incident to visible and invisible facets

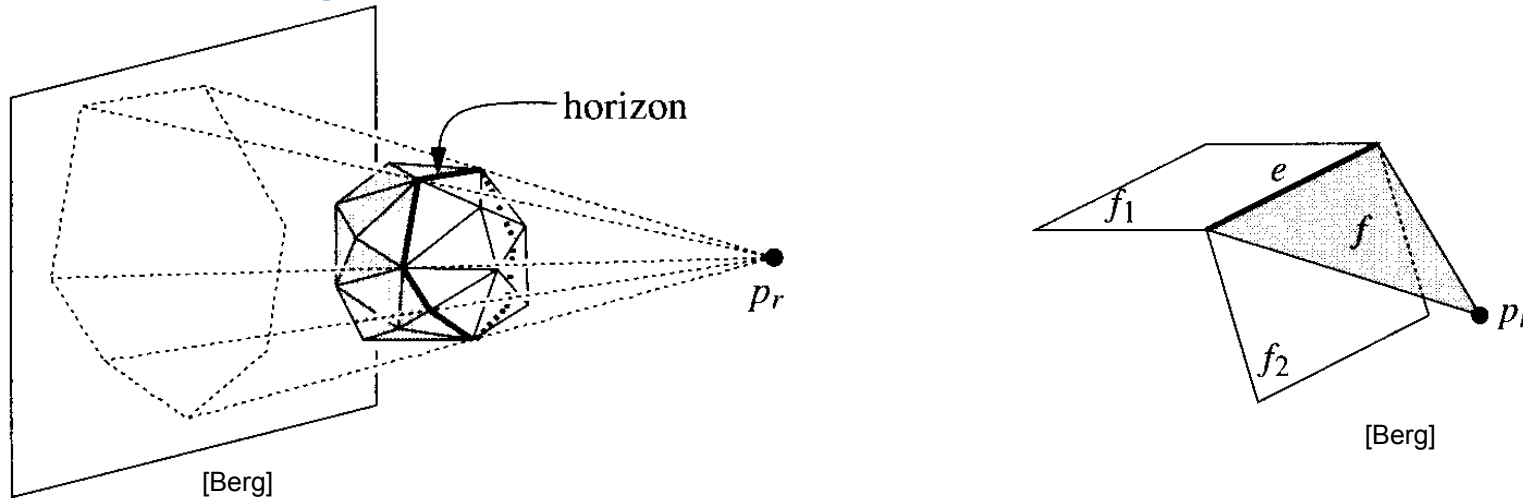

- **New triangle f** connects edge e on horizon and point p_r and
 - creates **new node for facet f** updates the conflict graph
 - add **arcs to points visible f** (subset from $P_{\text{conflict}}(f_1) \cup P_{\text{conflict}}(f_2)$)
- **Coplanar triangles** on the plane ep_r are merged with new triangle.
Conflicts are copied from the deleted triangle (same plane)



Incremental Convex hull algorithm

IncrementalConvexHull(P)

Input: Set of n points in general position in 3D space

Output: The convex hull $C=CH(P)$ of P

1. Find four points that form an initial tetrahedron, $C = CH(\{p_1, p_2, p_3, p_4\})$
2. Compute random permutation $\{p_5, p_6, \dots, p_n\}$ of the remaining points
3. Initialize the conflict graph with all visible pairs (p_t, f) ,
where f is facet of C and $p_t, t > 4$, are non-processed points
4. **for** $r = 5$ to n **do** ...insert p_r into C
5. | **if** $F_{\text{conflict}}(p_r)$ is not empty **then** ... p_r is outside, any facet is visible
6. | | Delete all facets $F_{\text{conflict}}(p_r)$ from C ... only from hull C , not from G
7. | | Walk around visible region boundary, create **list L of horizon edges**
8. | | **for** all $e \in L$ **do**
9. | | | connect e to p_r by a new triangular facet f
10. | | | **if** f is coplanar with its neighbor facet f' along e
11. | | | | **then** merge f and f' , take conflict list from f'
12. | | | | **else** ... determine conflicts for new face f
- | | | | ... [continue on the next slide]

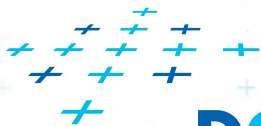

Incremental Convex hull algorithm (cont...)

```
12. | | | else ... not coplanar => determine conflicts for new face f
13. | | | | Create node for f in G //... new face in conflict graph G
14. | | | | Let f1 and f2 be the facets incident to e in the old CH(Pr-1)
15. | | | | P(e) = Pconflict(f1) ∪ Pconflict(f2)
16. | | | | for all points p ∈ P(e) do
17. | | | | | if f is visible from p, then add(p, f) to G ... new edges
18. | | | | Delete the node corresponding to pr and the nodes corresponding
    | | | | to facets in Fconflict(pr) from G, together with their incident arcs
19. return C
```

Complexity: Convex hull of a set of points in E^3 can be computed in $O(n \log n)$ randomized expected time

For proof see: [Berg, Section 11.3]



Conclusion

- Recapitulation of 2D algorithms
- 3D algorithms
 - Gift wrapping
 - D&C
 - Randomized incremental



References

- [Berg] Mark de Berg, Otfried Cheong, Marc van Kreveld, Mark Overmars: **Computational Geometry: *Algorithms and Applications***, Springer-Verlag, 3rd rev. ed. 2008. 386 pages, 370 fig. ISBN: 978-3-540-77973-5, Chapter 11, <http://www.cs.uu.nl/geobook/>
- [Boissonnat] J.-D. Boissonnat and M. Yvinec, ***Algorithmic Geometry***, Cambridge University Press, UK, 1998. Chapter 9 – Convex hulls
- [Preparata] Preparata, F.P., Shamos, M.I.: ***Computational Geometry. An Introduction***. Berlin, Springer-Verlag, 1985.
- [Mount] David Mount, - ***CMSC 754: Computational Geometry, Lecture Notes for Spring 2007***, University of Maryland, Lecture 3. <http://www.cs.umd.edu/class/spring2007/cmsc754/lectures.shtml>
- [Chan] Timothy M. Chan. Optimal output-sensitive convex hull algorithms in two and three dimensions., ***Discrete and Computational Geometry***, 16, 1996, 361-368. <http://citeseerx.ist.psu.edu/viewdoc/summary?doi=10.1.1.44.389>





**OPPA European Social Fund
Prague & EU: We invest in your future.**
