

# Statistical Machine Learning (BE4M33SSU)

## Lecture 8: Deep Neural Networks

Jan Drchal

Czech Technical University in Prague  
Faculty of Electrical Engineering  
Department of Computer Science

# Overview

Topics covered in the lecture:

- ◆ Deep Architectures
- ◆ Parameter initialization
- ◆ Convolutional Neural Networks (CNNs)
- ◆ Transfer learning

## Why Deep Architectures?

- ◆ Is it better to use deep architectures rather than the shallow ones for complex nonlinear mappings?
- ◆ We know that deep architectures evolved in Nature (e.g., cortex)
- ◆ Universal approximation theorem: one layer is enough so why to bother with more layers?
- ◆ Mhaskar et al: *Learning Functions: When Is Deep Better Than Shallow*, 2016:
  - deep neural networks can have exponentially less units than shallow networks for learning the same function
  - functions such as those realized by current deep convolutional neural networks are considered
- ◆ Handcrafted features vs. automatic extraction
- ◆ Gradually increasing complexity, intermediate representations: each successive layer brings higher abstraction

# Features in Deep Neural Networks

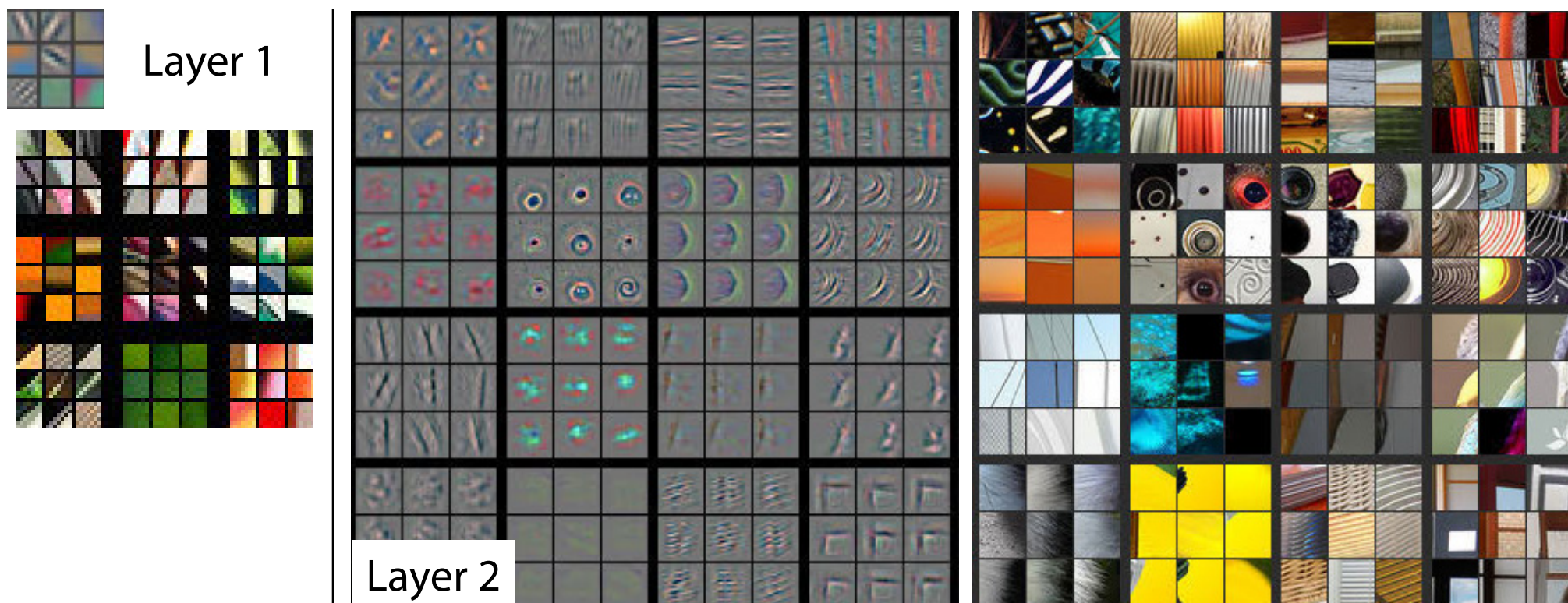

Zeiler and Fergus: *Visualizing and Understanding Convolutional Networks*, 2013

# Features in Deep Neural Networks

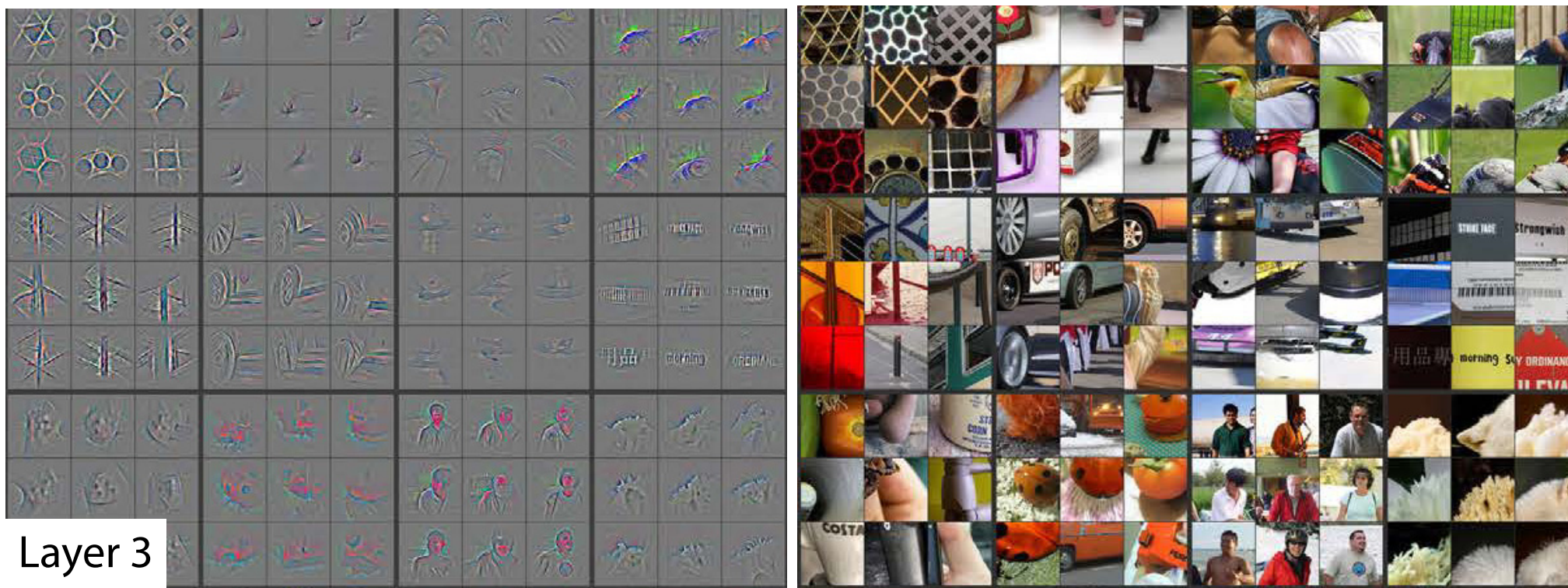

Layer 3

Zeiler and Fergus: *Visualizing and Understanding Convolutional Networks*, 2013

# Features in Deep Neural Networks

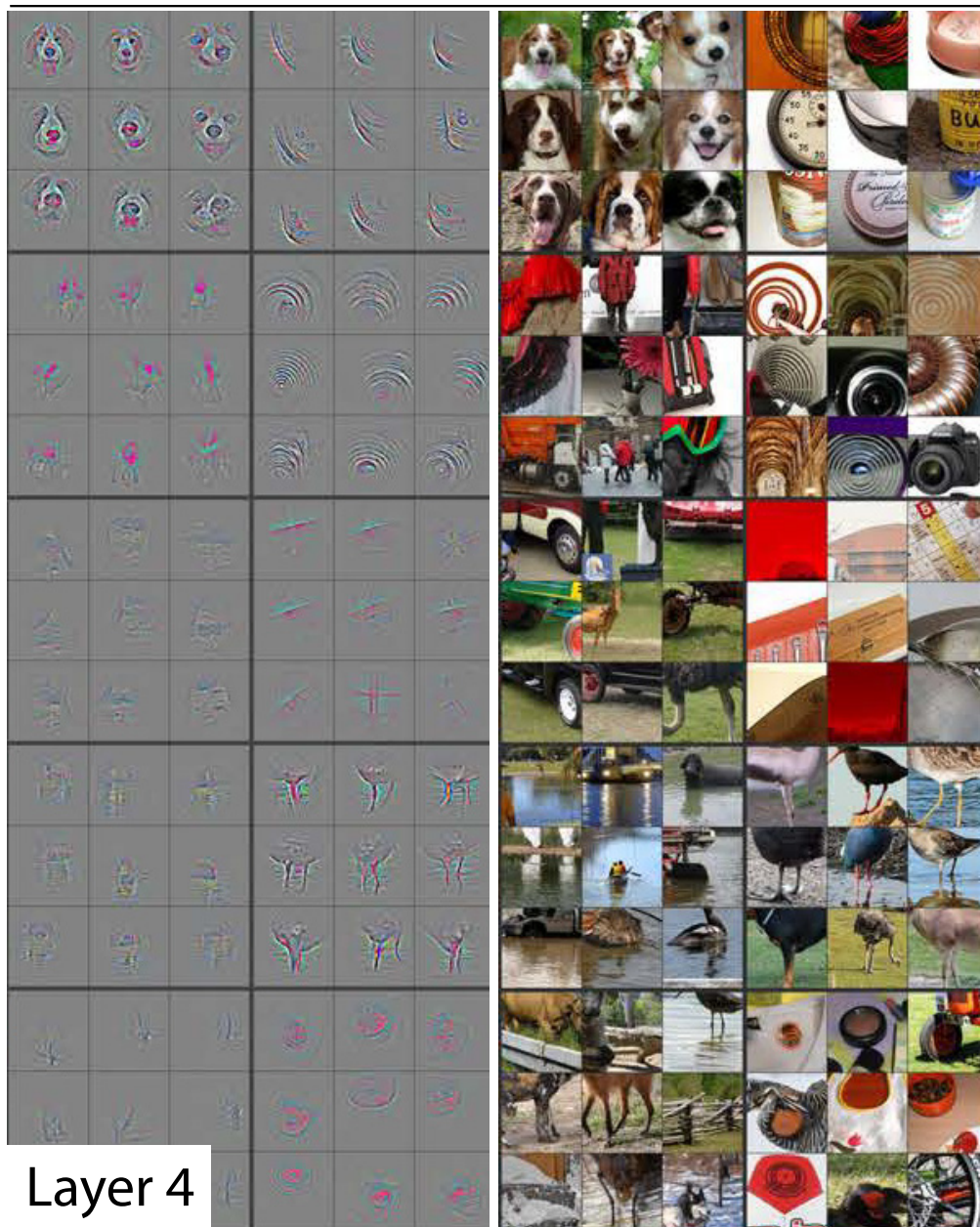

Layer 4

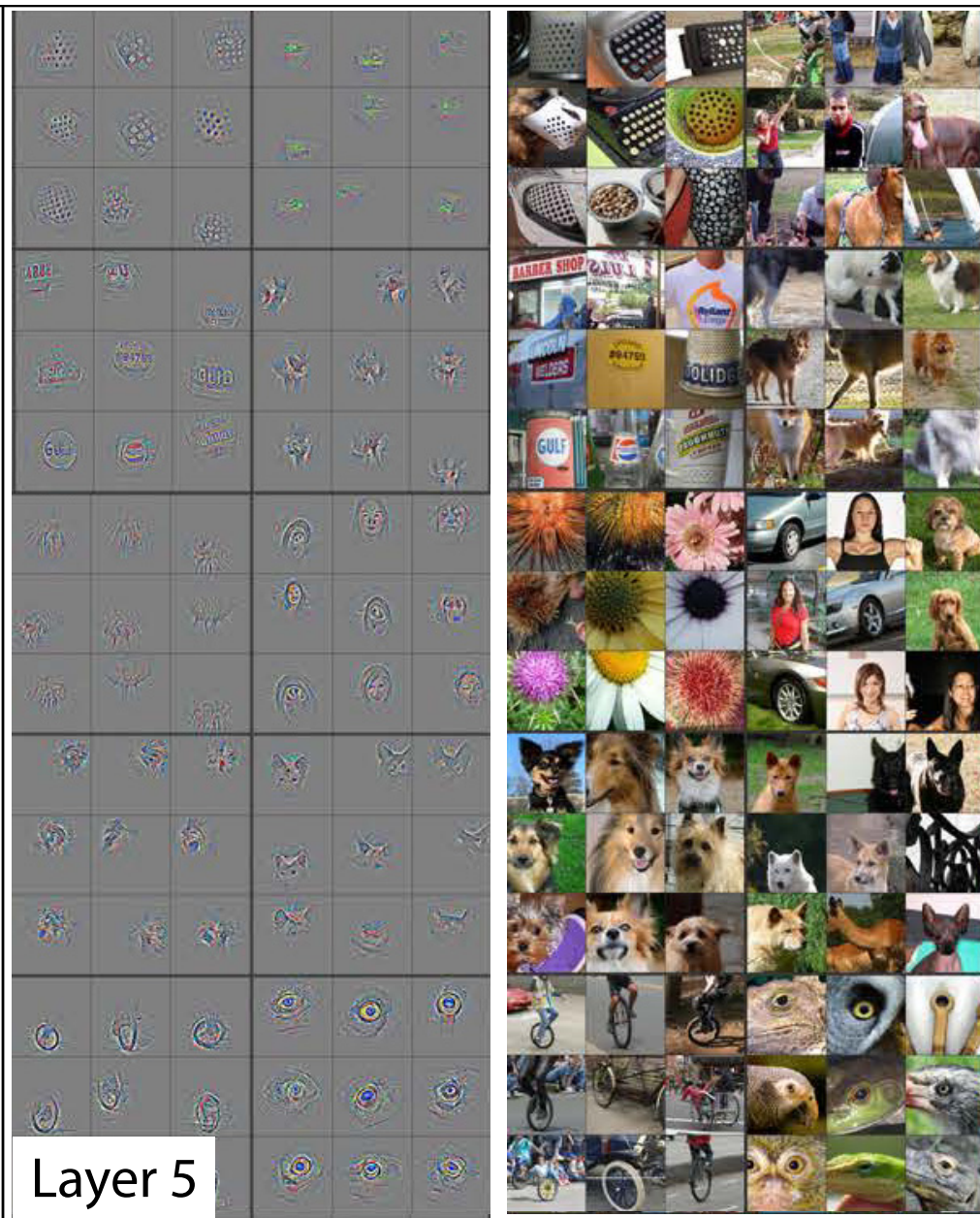

Layer 5

## Parameter Initialization

- ◆ Is it a good idea to set all weights to zero?
- ◆ **No.** All neurons would behave the same: the same  $\delta$ s are backpropagated. We need to *break the symmetry*
- ◆ Use small numbers, e.g., sample from a Gaussian distribution with zero mean:
  - works well for shallow networks,
  - for deep networks we might get into trouble

## Gaussian Initialization Example

- ◆ MLP, ten tanh layers, 500 units each. Each input fed with  $\mathcal{N}(0, 1)$
- ◆ Weights initialized to  $\mathcal{N}(0, \sigma^2)$

$$\sigma = 1$$

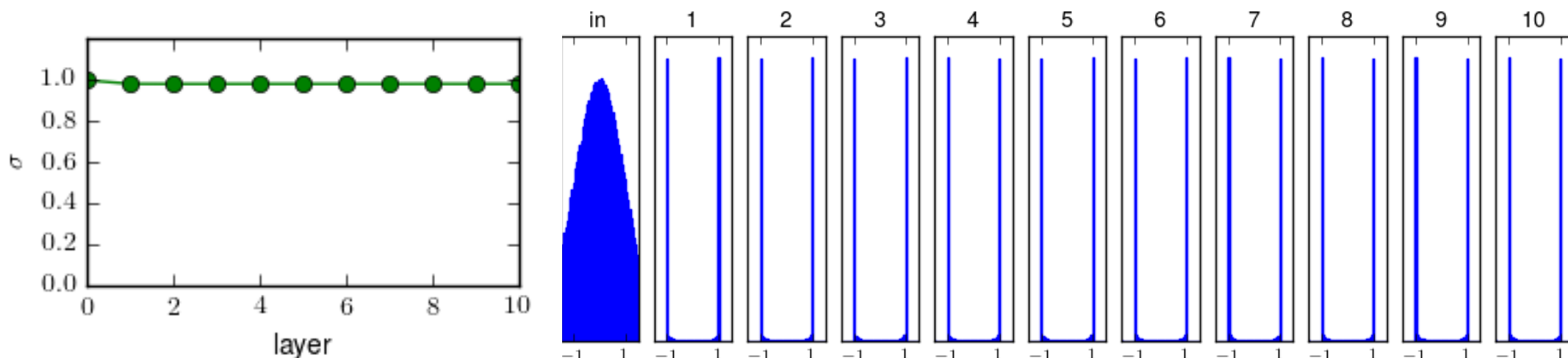

$$\sigma = 0.01$$

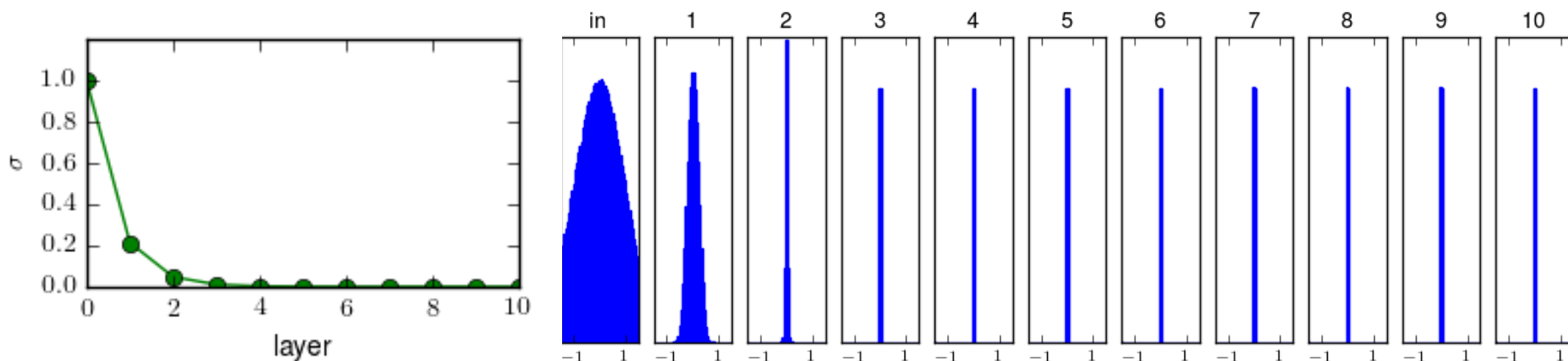



## Vanishing Gradient

- ◆ For large  $\sigma$  (saturation) the  $\tanh$  derivative is almost zero
- ◆ For small  $\sigma$  (output close to zero):
  - the derivative is at most 1,
  - the weights are very small and  $\frac{\partial z_j^{l+1}}{\partial z_i^l} = w_{ij}$  holds for the preceding linear layer
- ◆ In both cases:  $\delta \rightarrow 0$  as the number of layers increases

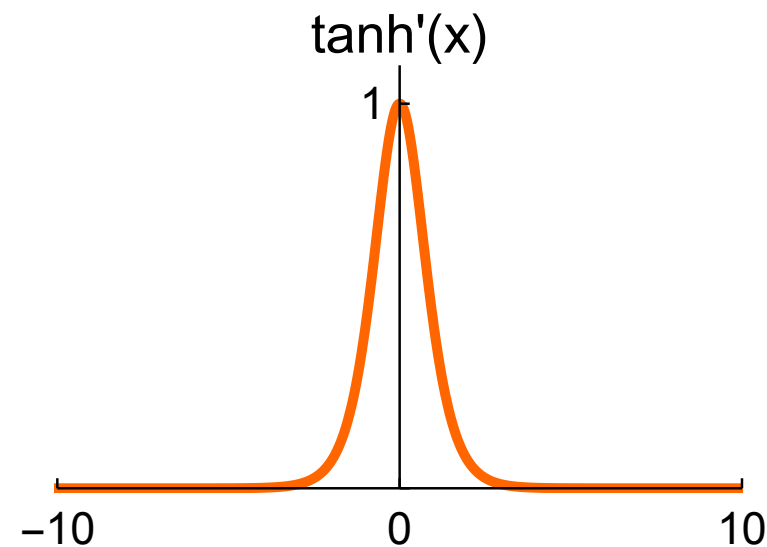
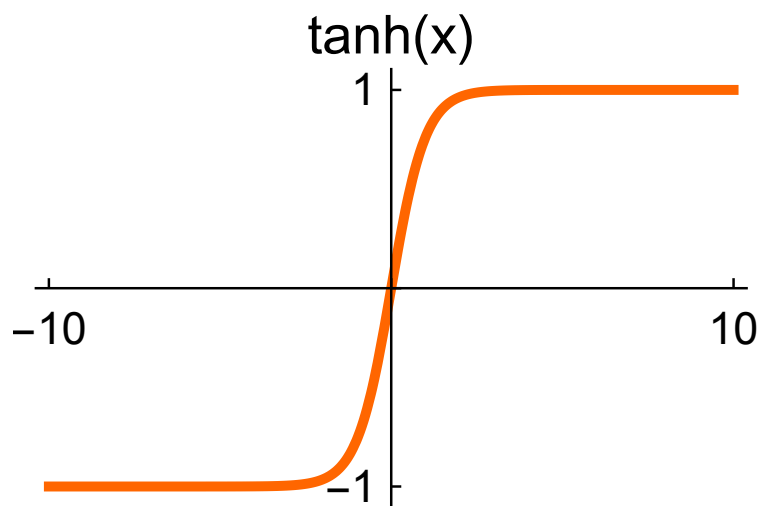

## Xavier Initialization

- ◆ Glorot and Bengio: *Understanding the difficulty of training deep feedforward neural networks*, 2010
- ◆ For the linear neuron  $s = \sum_i w_i x_i$ , let  $w_i$  and  $x_i$  be independent random variables,  $w_i$  and  $x_i$  are i.i.d.,  $E(x_i) = E(w_i) = 0$ :

$$\begin{aligned}
 \text{Var}(s) &= \text{Var} \left( \sum_i w_i x_i \right) = \sum_i \text{Var}(w_i x_i) = \\
 &= \sum_i \mathbb{E} \left( [w_i x_i - \mathbb{E}(w_i x_i)]^2 \right) = \sum_i \mathbb{E} \left( [w_i x_i - \mathbb{E}(w_i) \mathbb{E}(x_i)]^2 \right) = \\
 &= \sum_i \mathbb{E}(w_i^2 x_i^2) = \sum_i \mathbb{E}(w_i^2) E(x_i^2) = \\
 &= \sum_i \mathbb{E}([w_i - E(w_i)]^2) E([x_i - E(x_i)]^2) = \\
 &= \sum_i \text{Var}(x_i) \text{Var}(w_i) = n_{\text{in}} \text{Var}(x) \text{Var}(w)
 \end{aligned}$$

## Xavier Initialization (contd.)

- ◆ We have  $\text{Var}(s) = n_{\text{in}} \text{Var}(x) \text{Var}(w)$
- ◆ We want  $\text{Var}(s) = \text{Var}(x)$
- ◆ Choose  $\text{Var}(w) = \frac{1}{n_{\text{in}}}$
- ◆ Works well for tanh as it is linear near zero
- ◆ Do not forget to standardize ANN input data

tanh

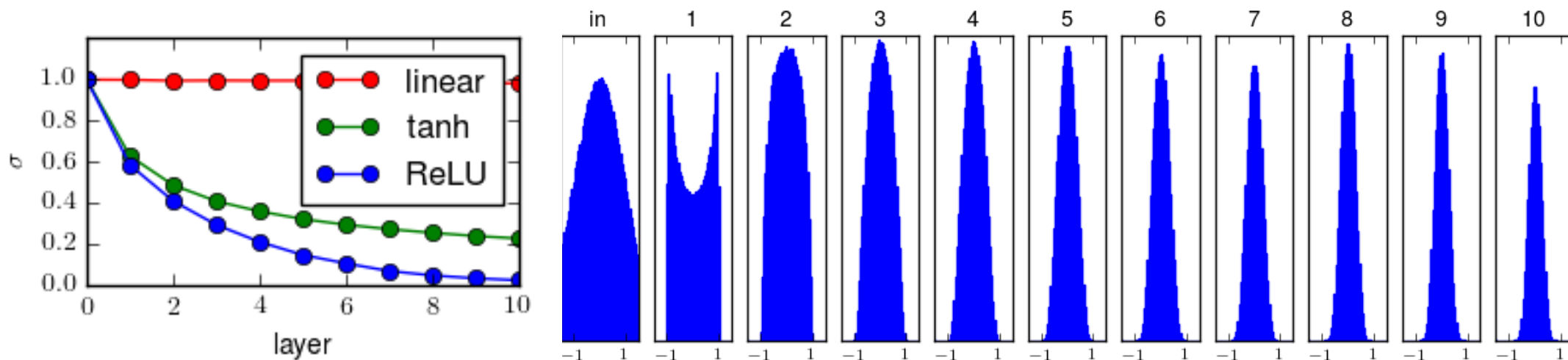

## Processing Images

- ◆ Input: grayscale image  $32 \times 32$  pixels
- ◆ Output: layer of  $32 \times 32$  features
- ◆ How many parameters do we need when input and output is fully connected?

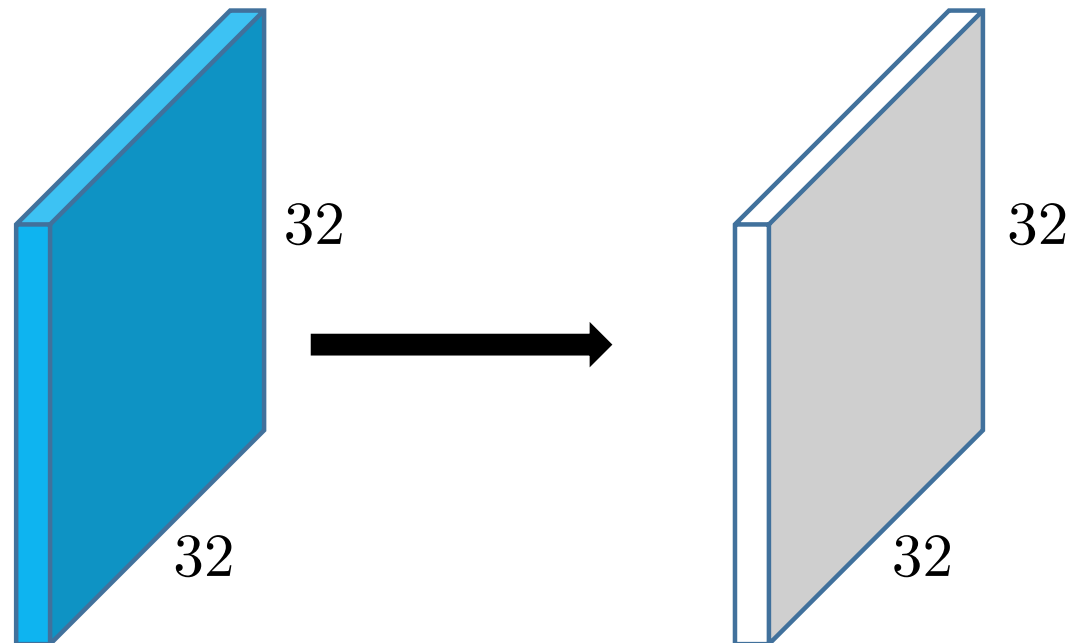

## Processing Images

- ◆ Input: grayscale image  $32 \times 32$  pixels
- ◆ Output: layer of  $32 \times 32$  features
- ◆ How many parameters do we need when input and output is fully connected?

$$32^2_{\text{outputs}} \times (32^2_{\text{inputs}} + 1_{\text{biases}}) \approx 1\text{M}$$

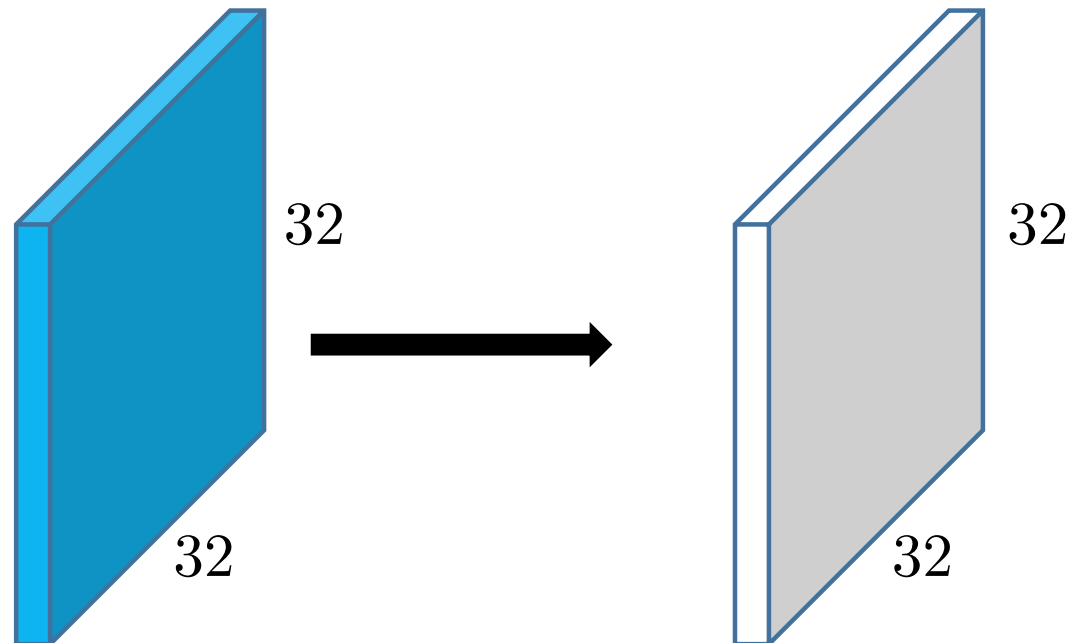

## Locally Connected Layer

- ◆ Motivation: topographical mapping in the visual cortex - nearby cells process nearby regions in the visual field
- ◆ Each neuron has a **receptive field** of  $3 \times 3$  pixels
- ◆ It is fully connected only to the corresponding set of 9 inputs
- ◆ How many parameters do we need now?

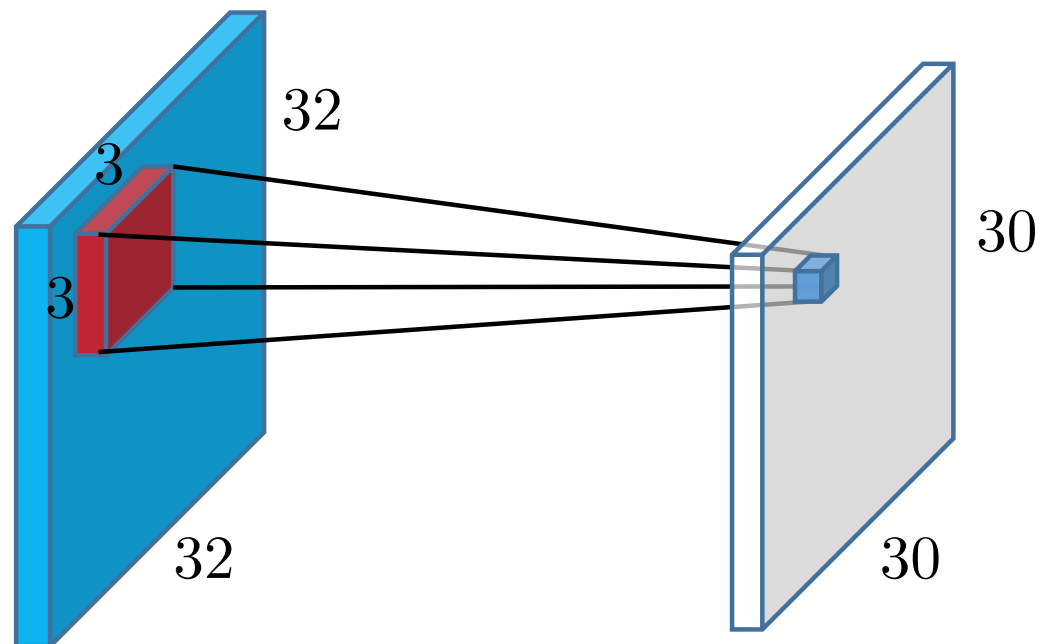

## Locally Connected Layer

- ◆ Motivation: topographical mapping in the visual cortex - nearby cells process nearby regions in the visual field
- ◆ Each neuron has a **receptive field** of  $3 \times 3$  pixels
- ◆ It is fully connected only to the corresponding set of 9 inputs
- ◆ How many parameters do we need now?

$$30^2 \times \left( 3^2 + 1 \right) = 9k$$

outputs
inputs
bias

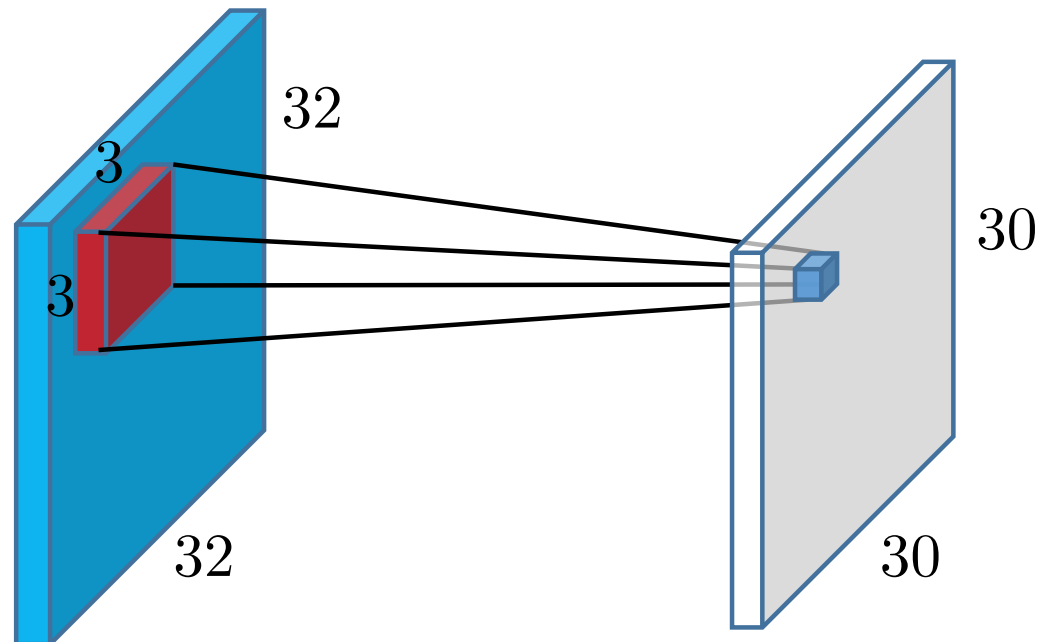

## Multiple Input Channels

- ◆ We can have more input channels, e.g., colors
- ◆ Now the input is defined by width, height and depth:  $32 \times 32 \times 3$
- ◆ The number of parameters is  $30^2 \times (3 \times 3^2 + 1) \approx 25k$   
outputs channels inputs bias

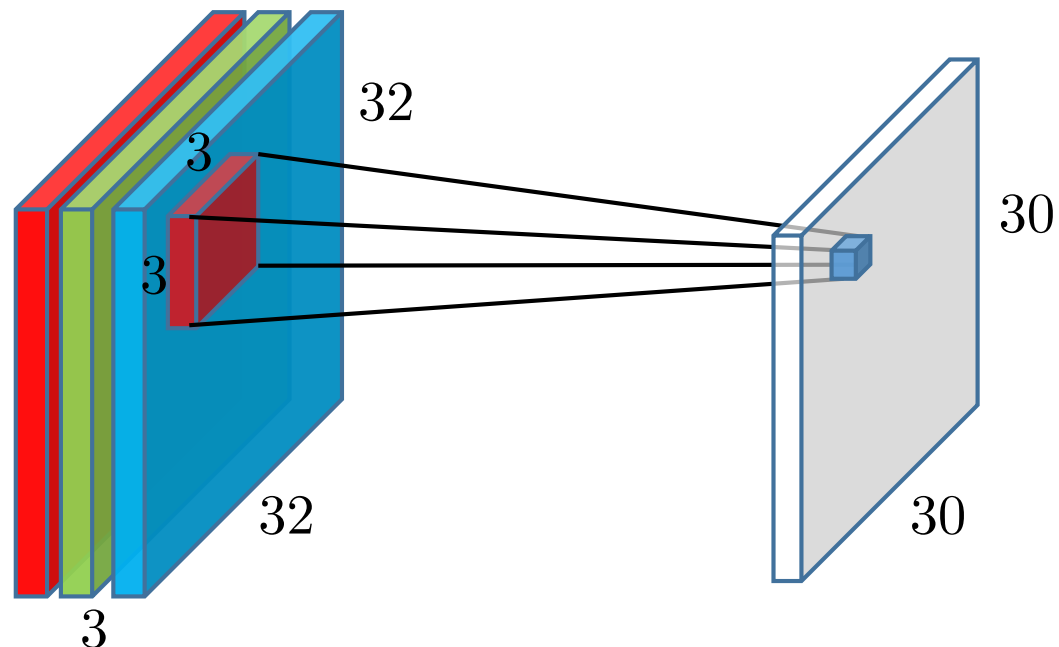



# Sharing Parameters

- ◆ We can further reduce the number of parameters by sharing weights
- ◆ Use the same set of weights and bias for all outputs, define a *filter*
- ◆ The number of parameters drops to  $3 \times 3^2 + 1 = 28$   
inputs      bias
- ◆ Translation *equivariance*

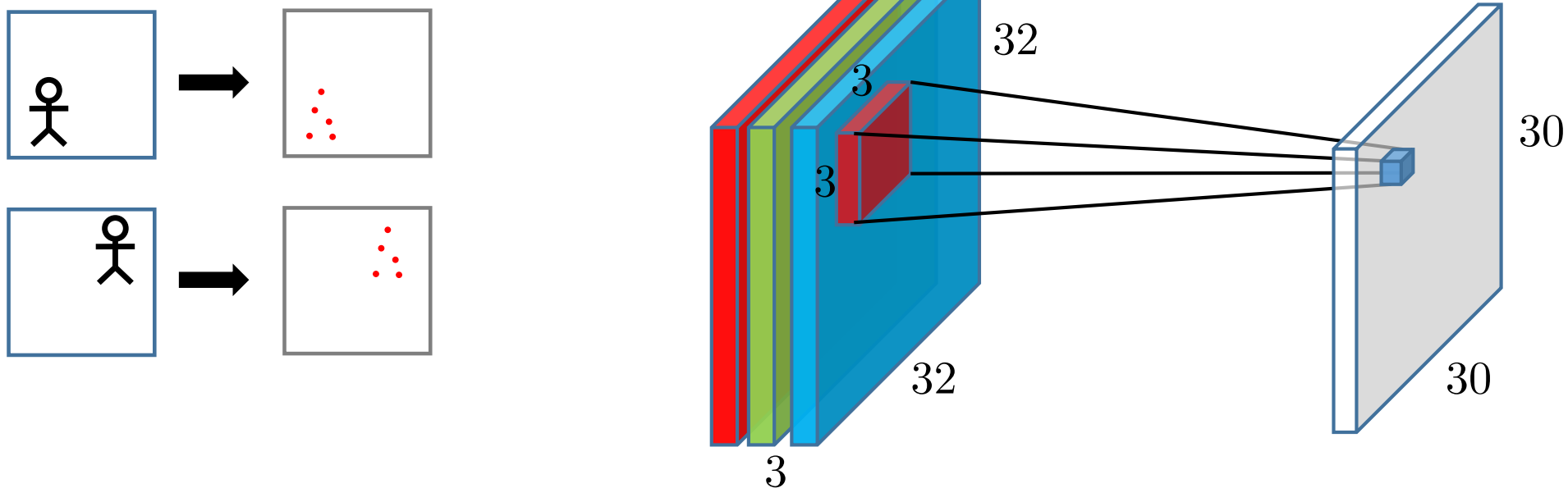





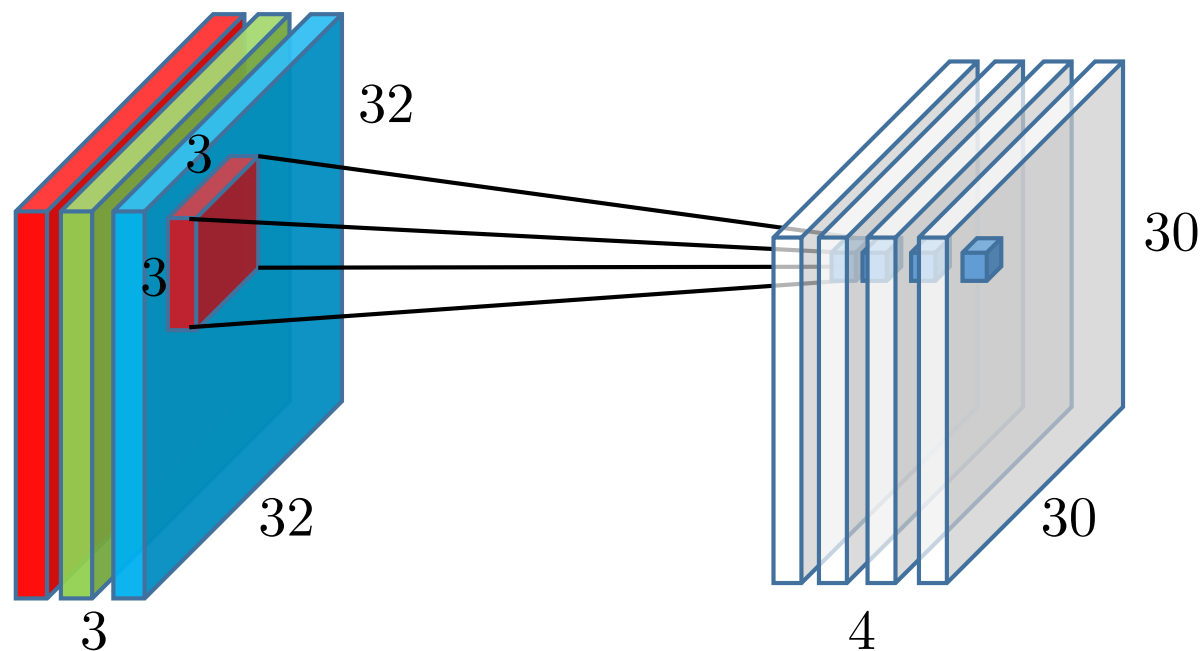

## Multiple Output Channels

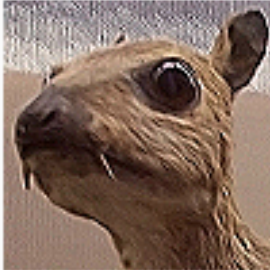
- ◆ Extract multiple different of features
- ◆ Use multiple *filters* to get more *feature maps*
- ◆ For 4 filters we have  $4 \times (3 \times 3^2 + 1) = 112$  parameters
- ◆ This is the **convolutional layer**
- ◆ Processes *volume* into *volume*



# Convolution Applied to an Image

<b>Identity</b>	$\begin{bmatrix} 0 & 0 & 0 \\ 0 & 1 & 0 \\ 0 & 0 & 0 \end{bmatrix}$		<b>Sharpen</b>	$\begin{bmatrix} 0 & -1 & 0 \\ -1 & 5 & -1 \\ 0 & -1 & 0 \end{bmatrix}$	
<b>Edge detection</b>	$\begin{bmatrix} 1 & 0 & -1 \\ 0 & 0 & 0 \\ -1 & 0 & 1 \end{bmatrix}$		<b>Box blur</b> (normalized)	$\frac{1}{9} \begin{bmatrix} 1 & 1 & 1 \\ 1 & 1 & 1 \\ 1 & 1 & 1 \end{bmatrix}$	
	$\begin{bmatrix} 0 & 1 & 0 \\ 1 & -4 & 1 \\ 0 & 1 & 0 \end{bmatrix}$		<b>Gaussian blur</b> (approximation)	$\frac{1}{16} \begin{bmatrix} 1 & 2 & 1 \\ 2 & 4 & 2 \\ 1 & 2 & 1 \end{bmatrix}$	
	$\begin{bmatrix} -1 & -1 & -1 \\ -1 & 8 & -1 \\ -1 & -1 & -1 \end{bmatrix}$				

[https://en.wikipedia.org/wiki/Kernel\\_\(image\\_processing\)](https://en.wikipedia.org/wiki/Kernel_(image_processing))

## Convolution in 2D: Forward Message

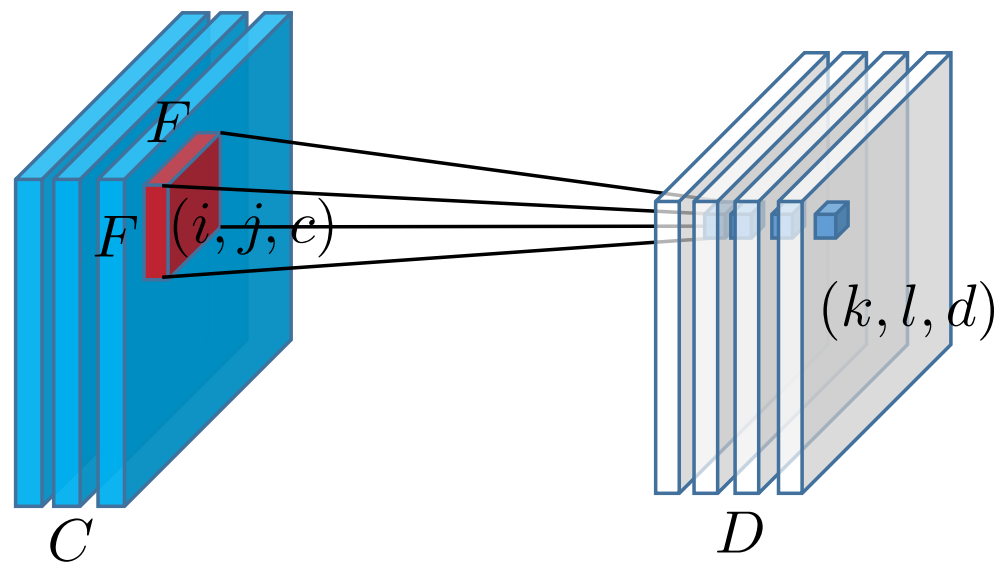

$$z_{kld} = f_{kld}(\mathbf{x}, \mathbf{w}, \mathbf{b}) = b_d + \sum_{i=1}^F \sum_{j=1}^F \sum_{c=1}^C x_{k+i-1, l+j-1, c} w_{ijcd}$$

# Stride

- ◆ Stride hyper parameter, typically  $S \in \{1, 2\}$
- ◆ Higher stride produces smaller output volumes spatially

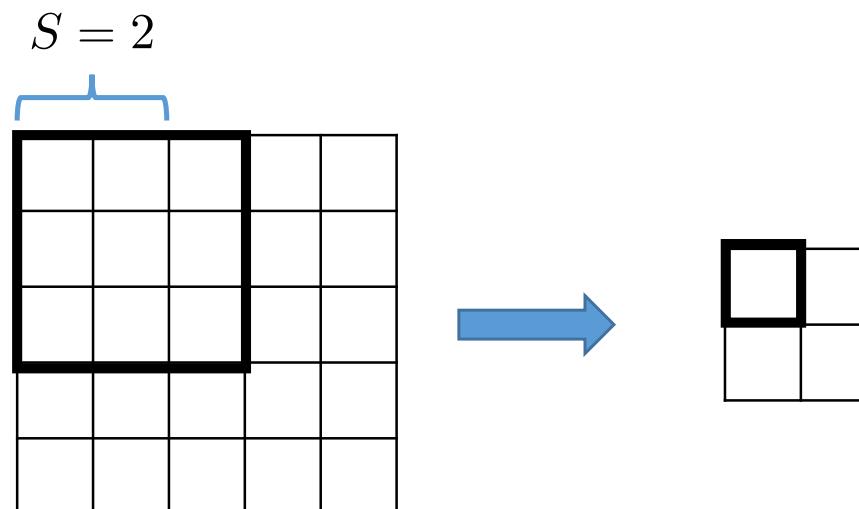
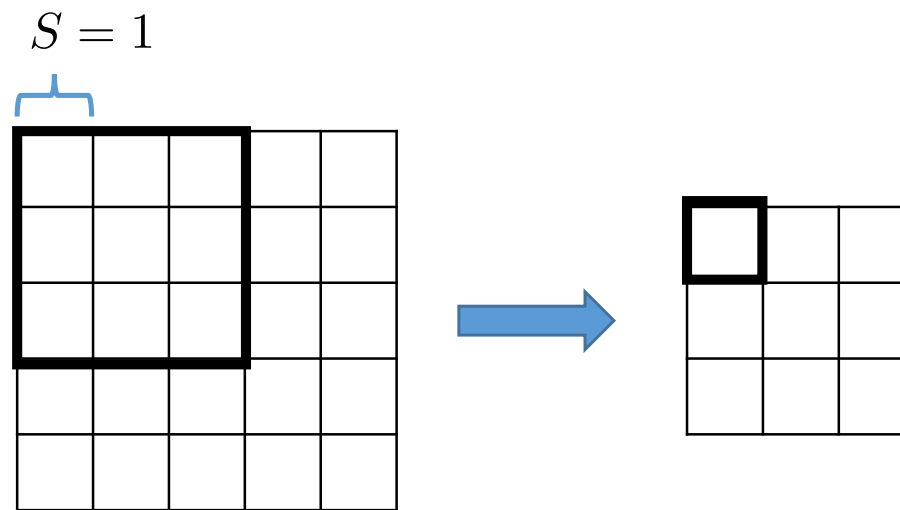

# Stride

- ◆ Stride hyper parameter, typically  $S \in \{1, 2\}$
- ◆ Higher stride produces smaller output volumes spatially

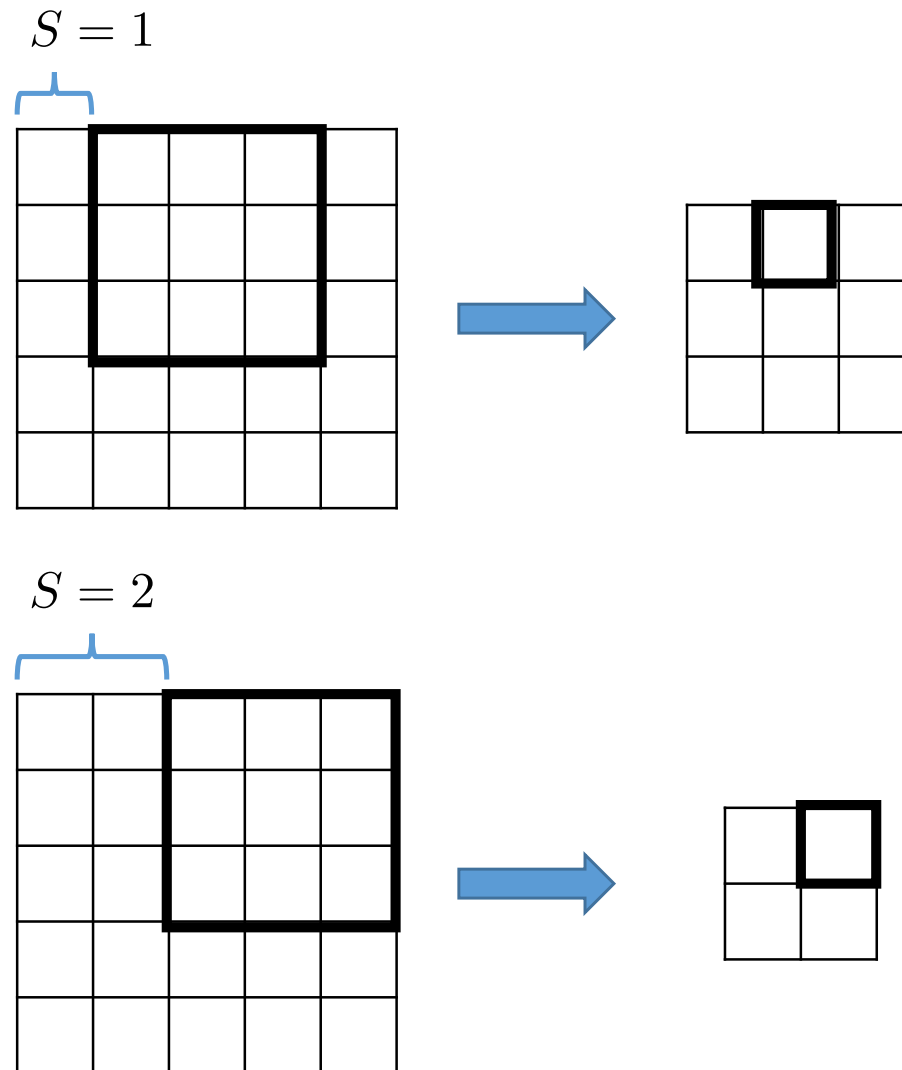



## Convolutional Layer Summary

- ◆ Input volume:  $W_{\text{input}} \times H_{\text{input}} \times C$
- ◆ Output volume:  $W_{\text{output}} \times H_{\text{output}} \times D$
- ◆ Having  $D$  filters:
  - receptive field of  $F \times F$  units,
  - stride  $S$
  - zero padding  $P$

$$W_{\text{output}} = (W_{\text{input}} - F + 2P) / S + 1$$

$$H_{\text{output}} = (H_{\text{input}} - F + 2P) / S + 1$$

- ◆ Needs  $F^2CD$  weights and  $D$  biases
- ◆ The number of activations and  $\delta$ s to store:  $W_{\text{output}} \times H_{\text{output}} \times D$



## Convolutional Layer: Nonlinearities

- ◆ In most cases a nonlinearity (sigmoid, tanh, ReLU) is applied to the outputs of the convolutional layer
- ◆ Example: ReLU units

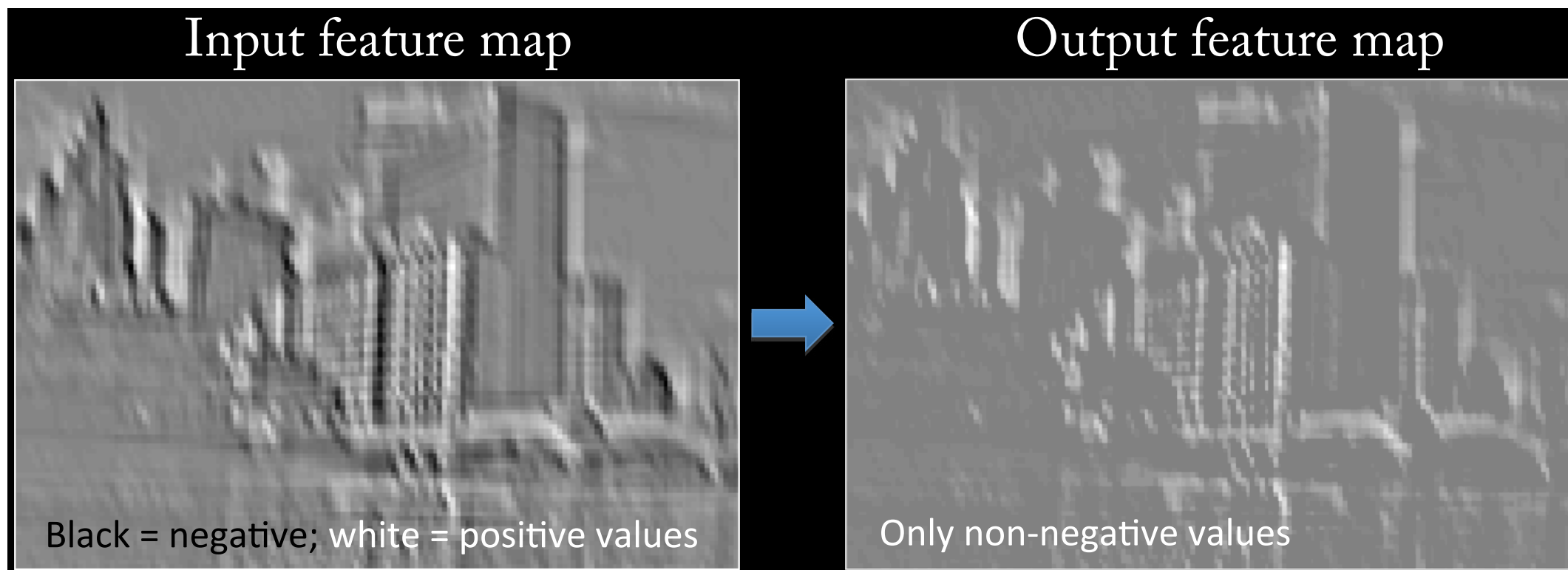

# Max Pooling

- ◆ Reduces spatial resolution → less parameters → helps with overfitting
- ◆ Introduces translation invariance and invariance to small rotations
- ◆ Depth is not affected

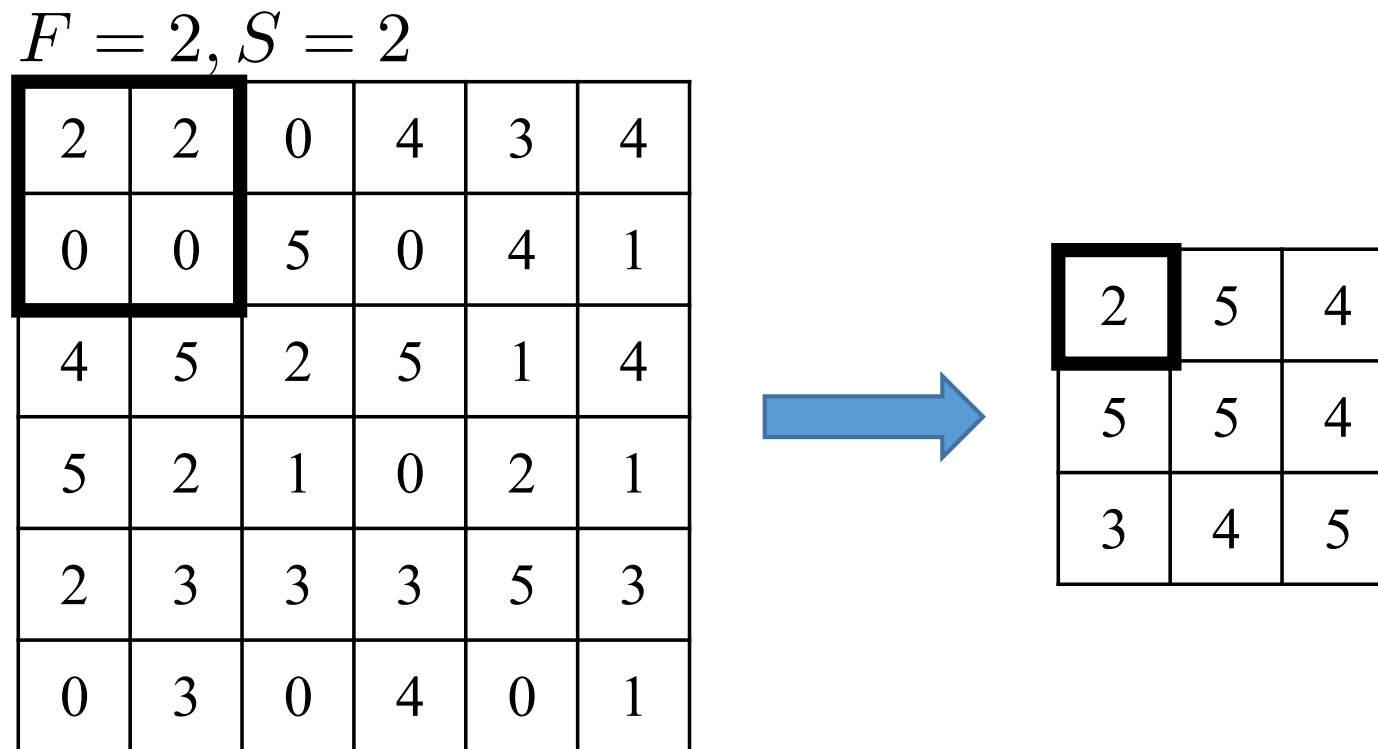

# Convolutional Neural Networks (CNNs)

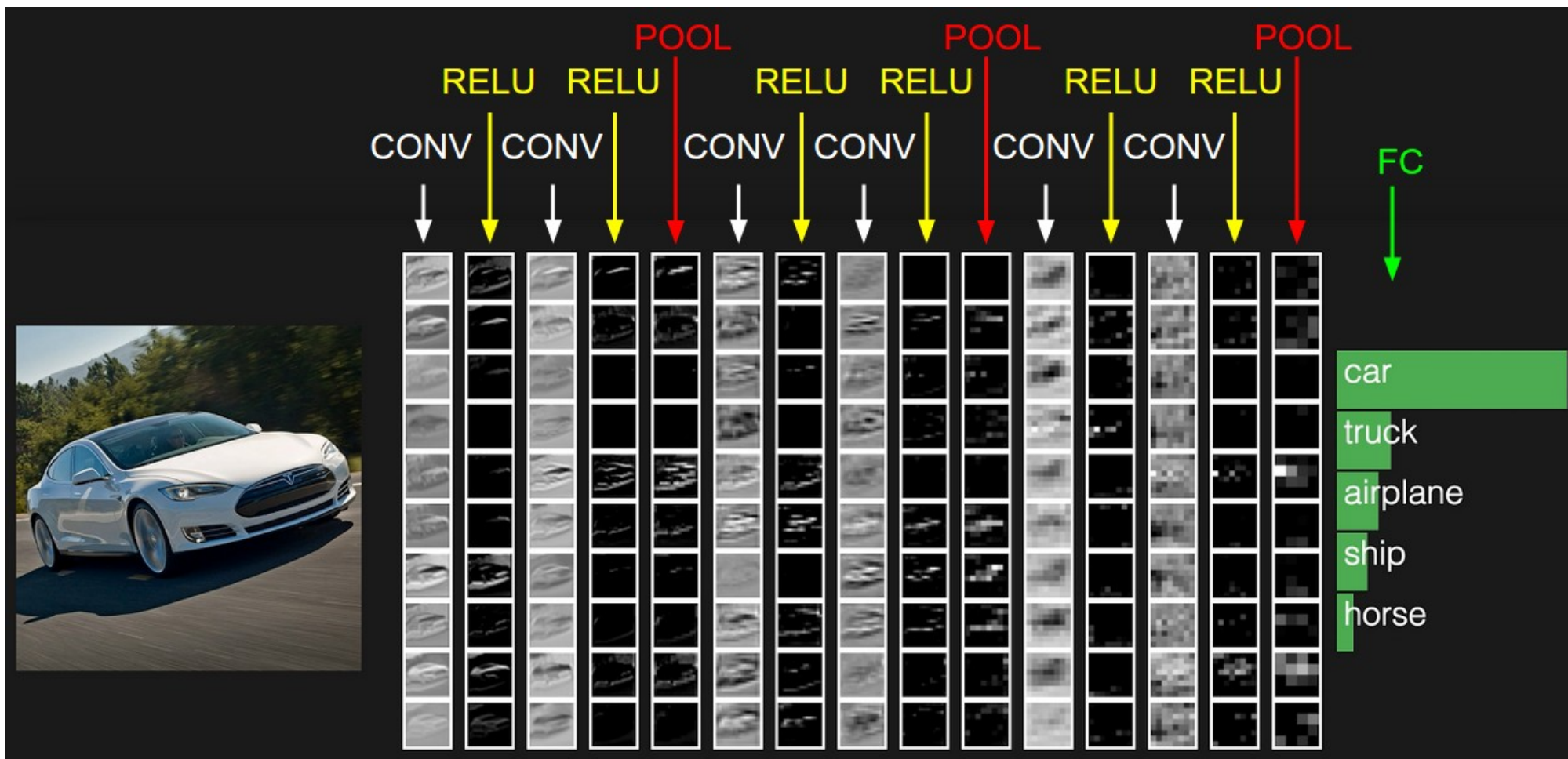

<http://cs231n.github.io/convolutional-networks/>

# VGGNet 2014

- ◆ Simonyan, Zisserman: *Very Deep Convolutional Networks for Large-Scale Image Recognition*, 2014
- ◆ Lowering filter spatial resolution ( $F = 3, S = 1, P = 1$ ), increasing depth
- ◆ A sequence of  $3 \times 3$  filters can emulate a single large one
- ◆ Top five error 7.3%, 6.8% for an ensemble of 2 CNNs



## Convolutional vs. Fully-Connected Layers

- ◆ Convolutional layer can be simply transformed to a Fully-connected layer  
→ sparse weight matrix
- ◆ The other direction is also possible:  
FC layer of  $D$  units following a  $F \times F \times C$  convolutional layer can be replaced by a  $1 \times 1 \times D$  convolutional layer using  $F \times F$  filters ( $P = 0$ ,  $S = 1$ )
- ◆ In both cases you do not have to recompute the weights, you just rearrange them

# Fully-Connected Layer to Convolutional Example

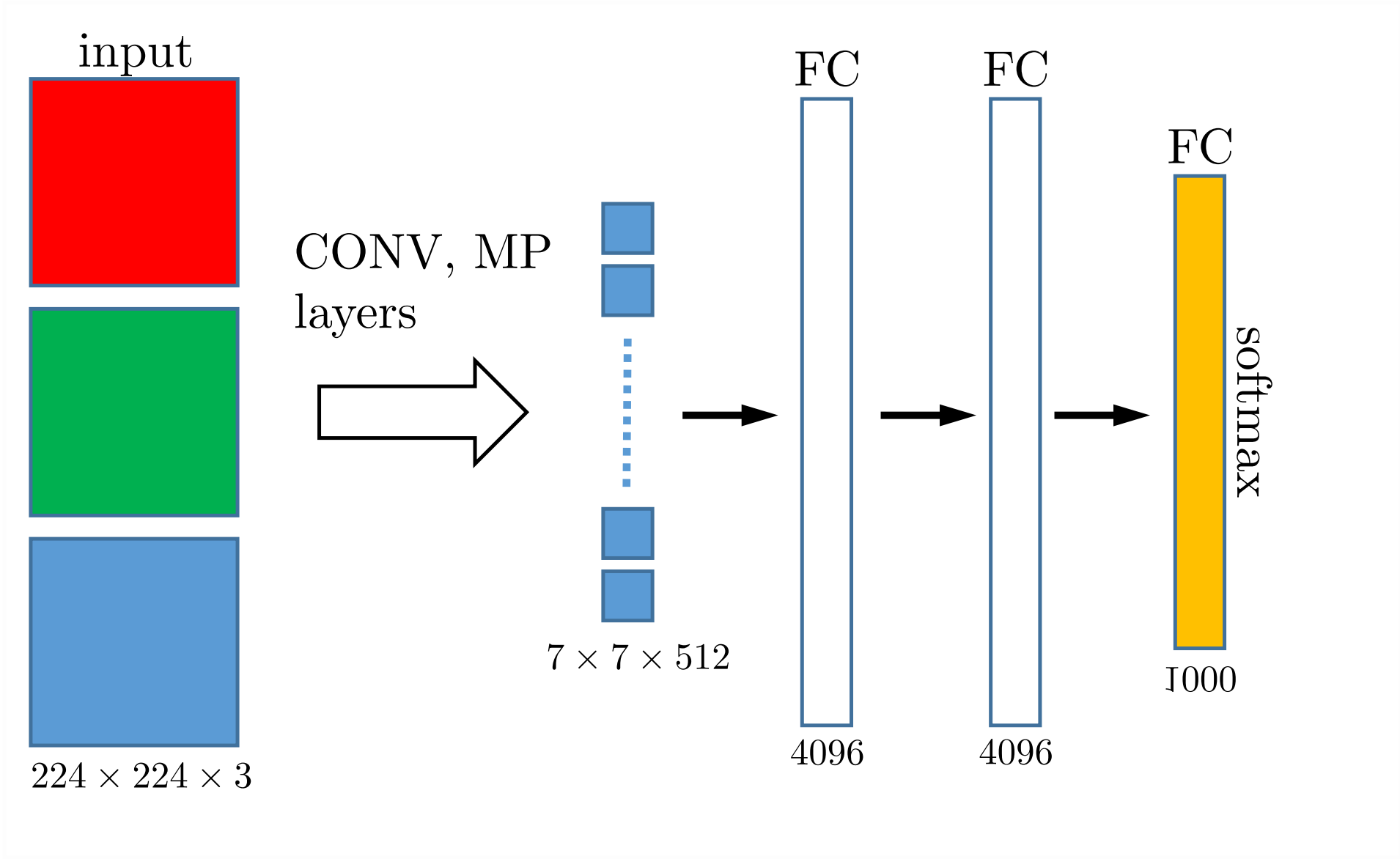

# Fully-Connected Layer to Convolutional Example

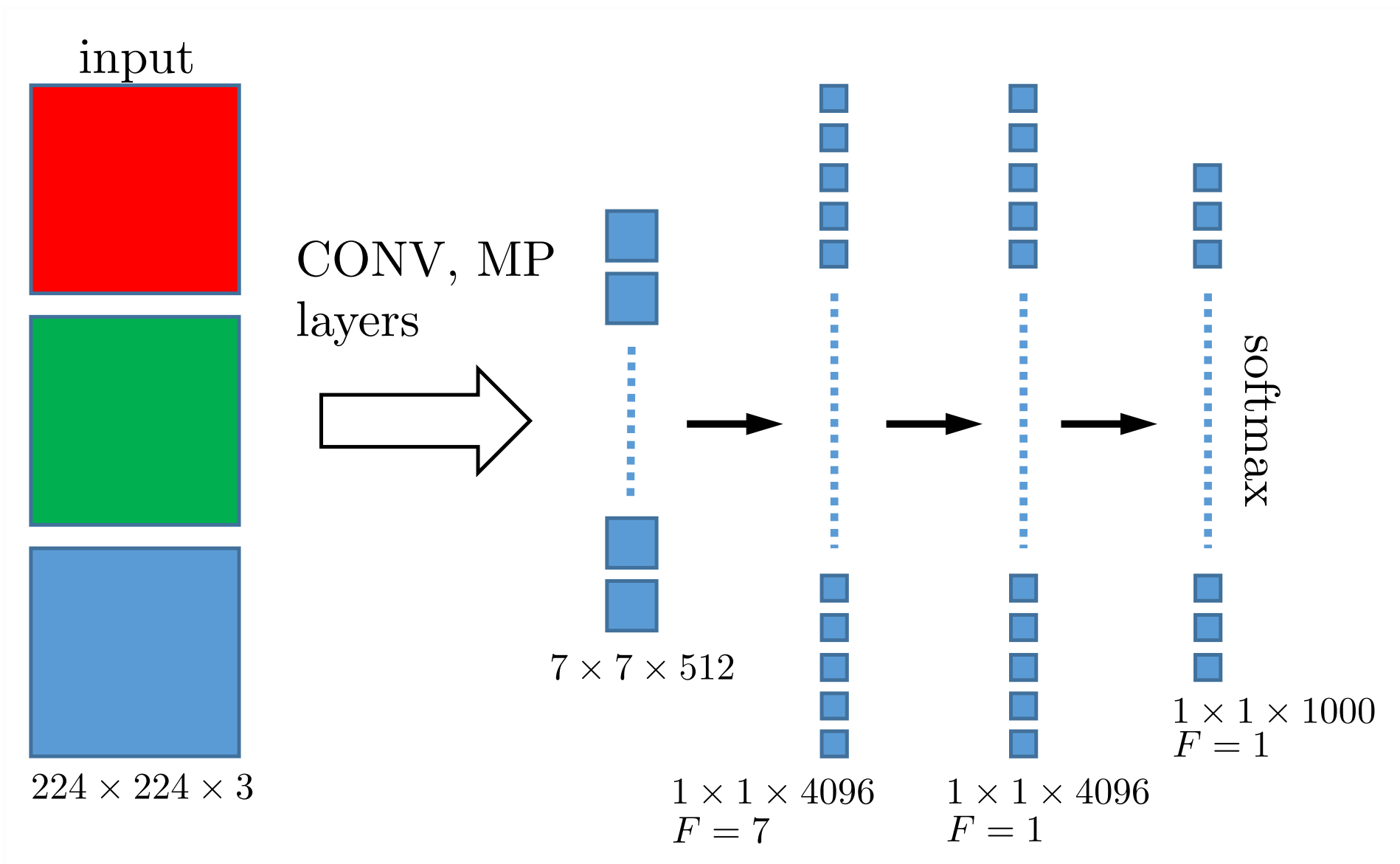

# Fully-Connected Layer to Convolutional Example

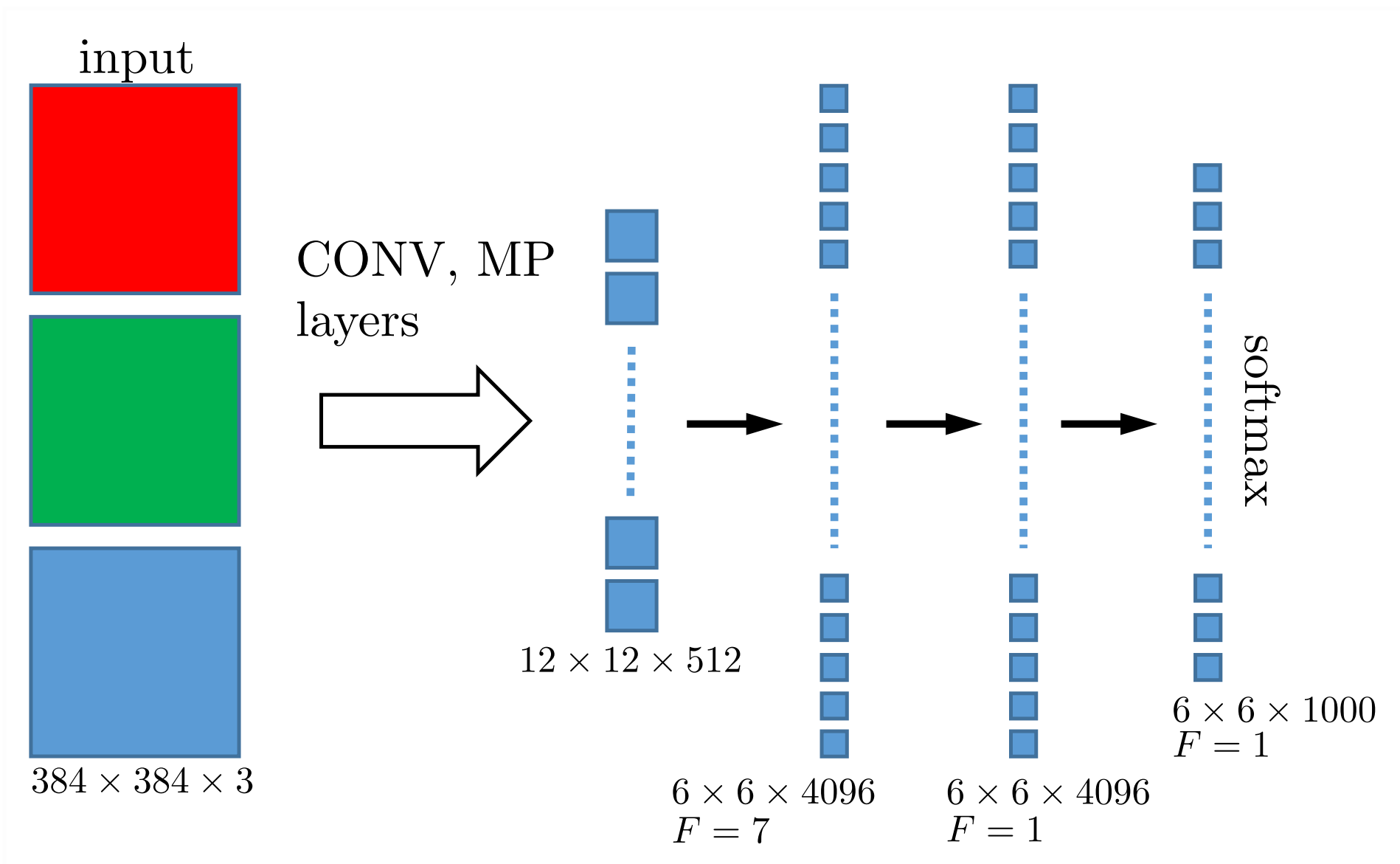



# Transfer Learning

- ◆ Idea: use an existing model as a base to solve a *similar problem*
- ◆ Often used when not enough data available to solve the target problem directly
- ◆ Example: reuse an ImageNet network for object localization

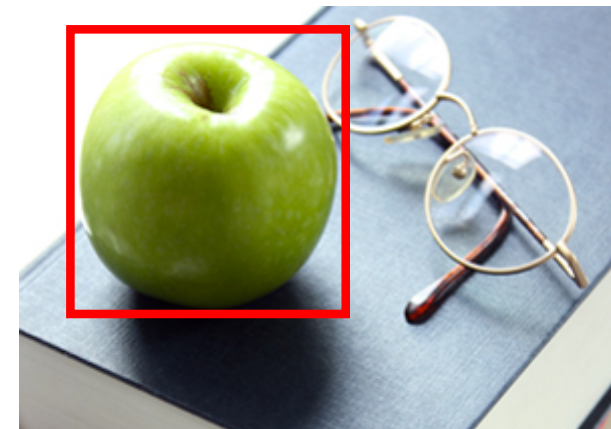
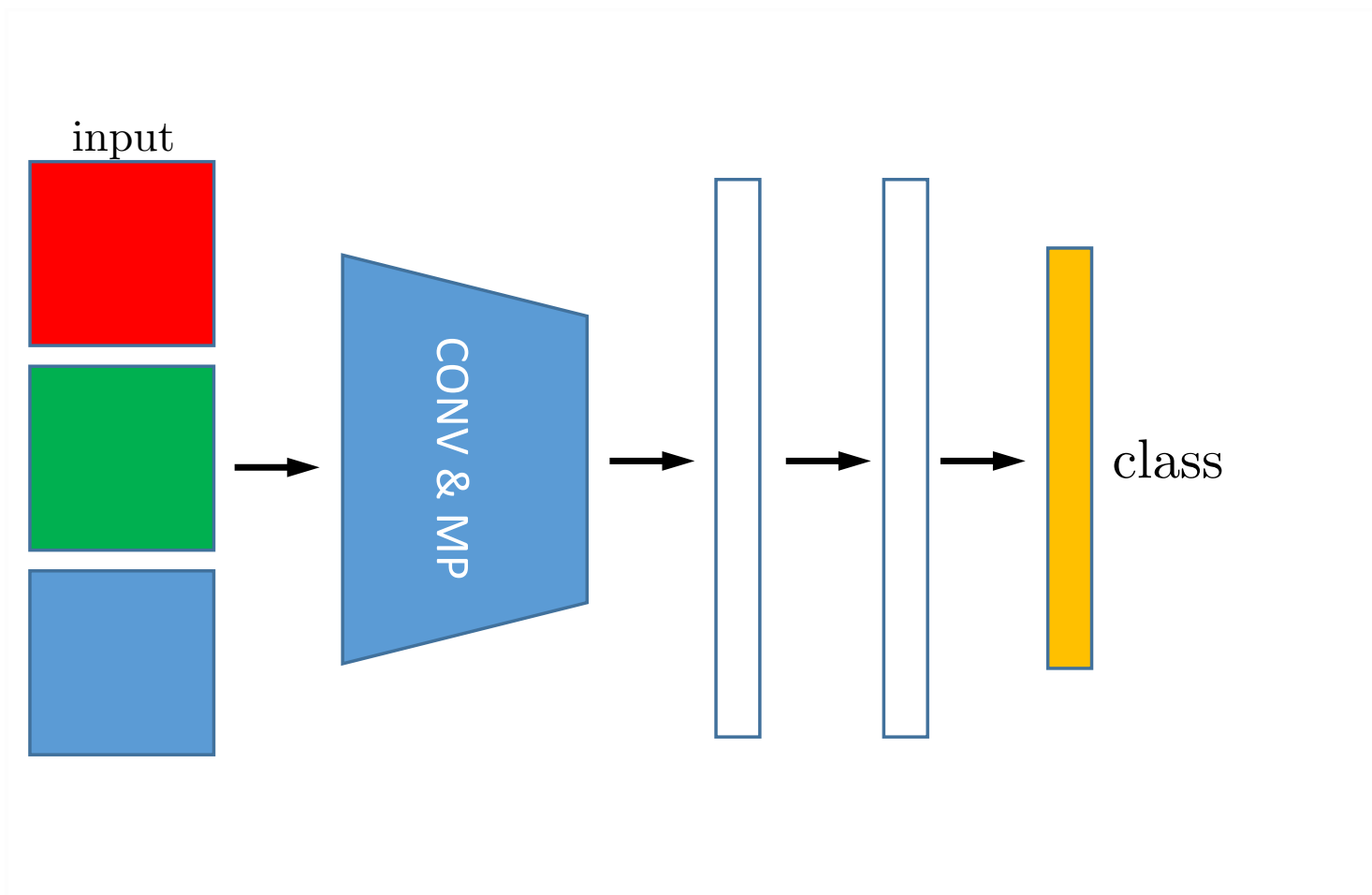

# Transfer Learning

- ◆ Idea: use an existing model as a base to solve a *similar problem*
- ◆ Often used when not enough data available to solve the target problem directly
- ◆ Example: reuse an ImageNet network for object localization

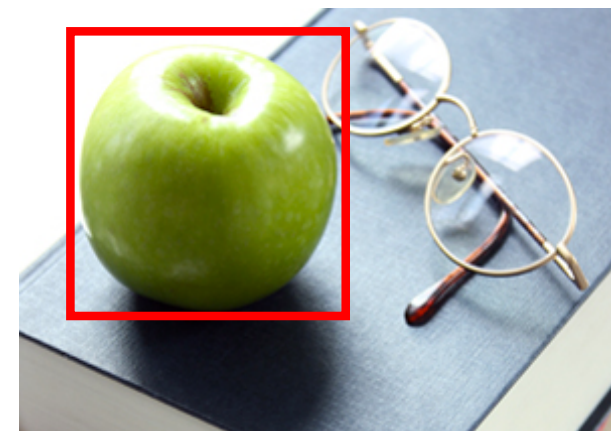
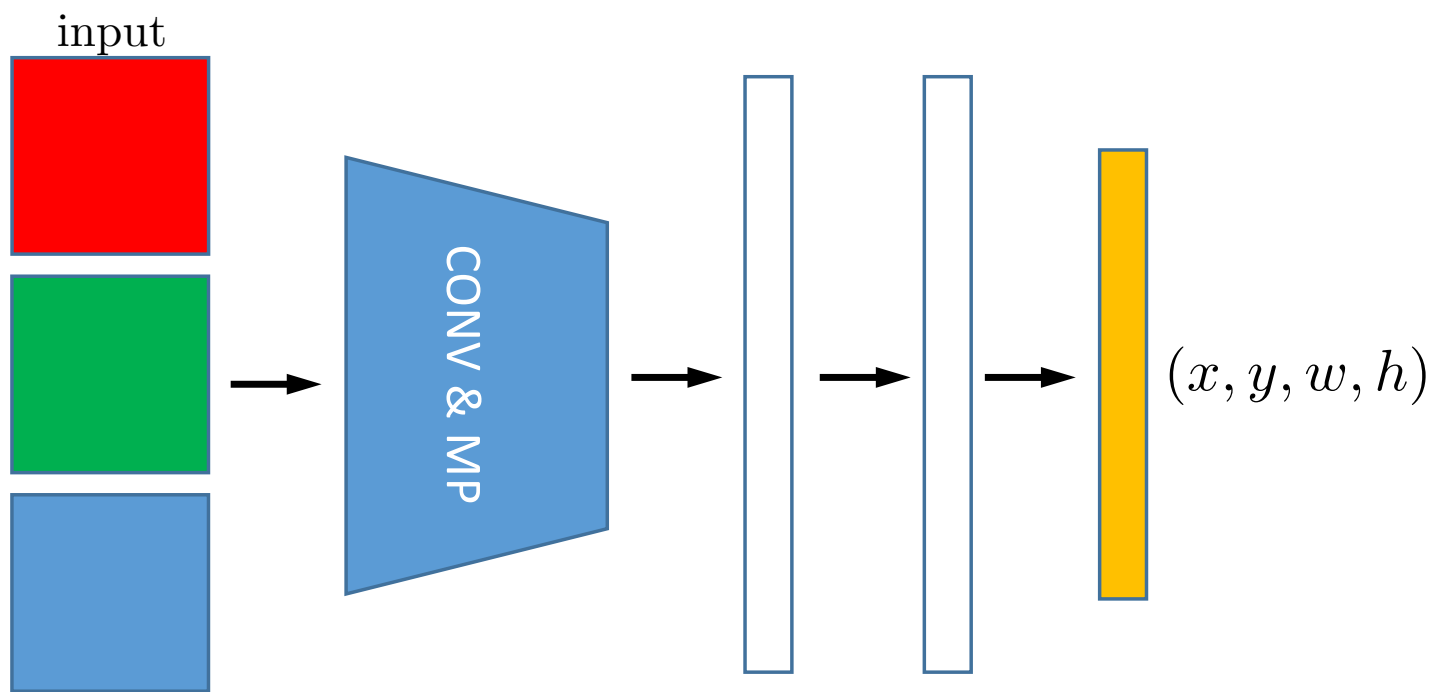

# Transfer Learning

- ◆ Idea: use an existing model as a base to solve a *similar problem*
- ◆ Often used when not enough data available to solve the target problem directly
- ◆ Example: reuse an ImageNet network for object localization

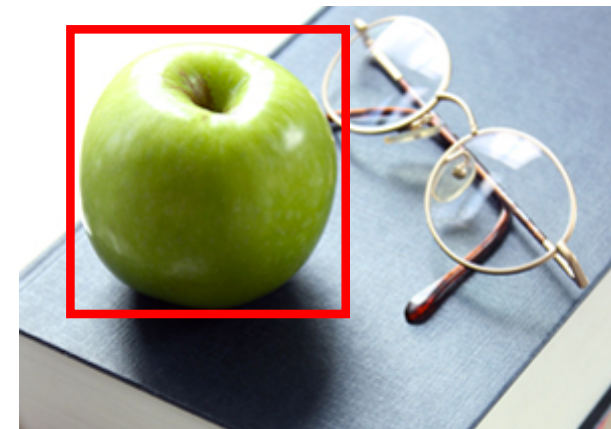
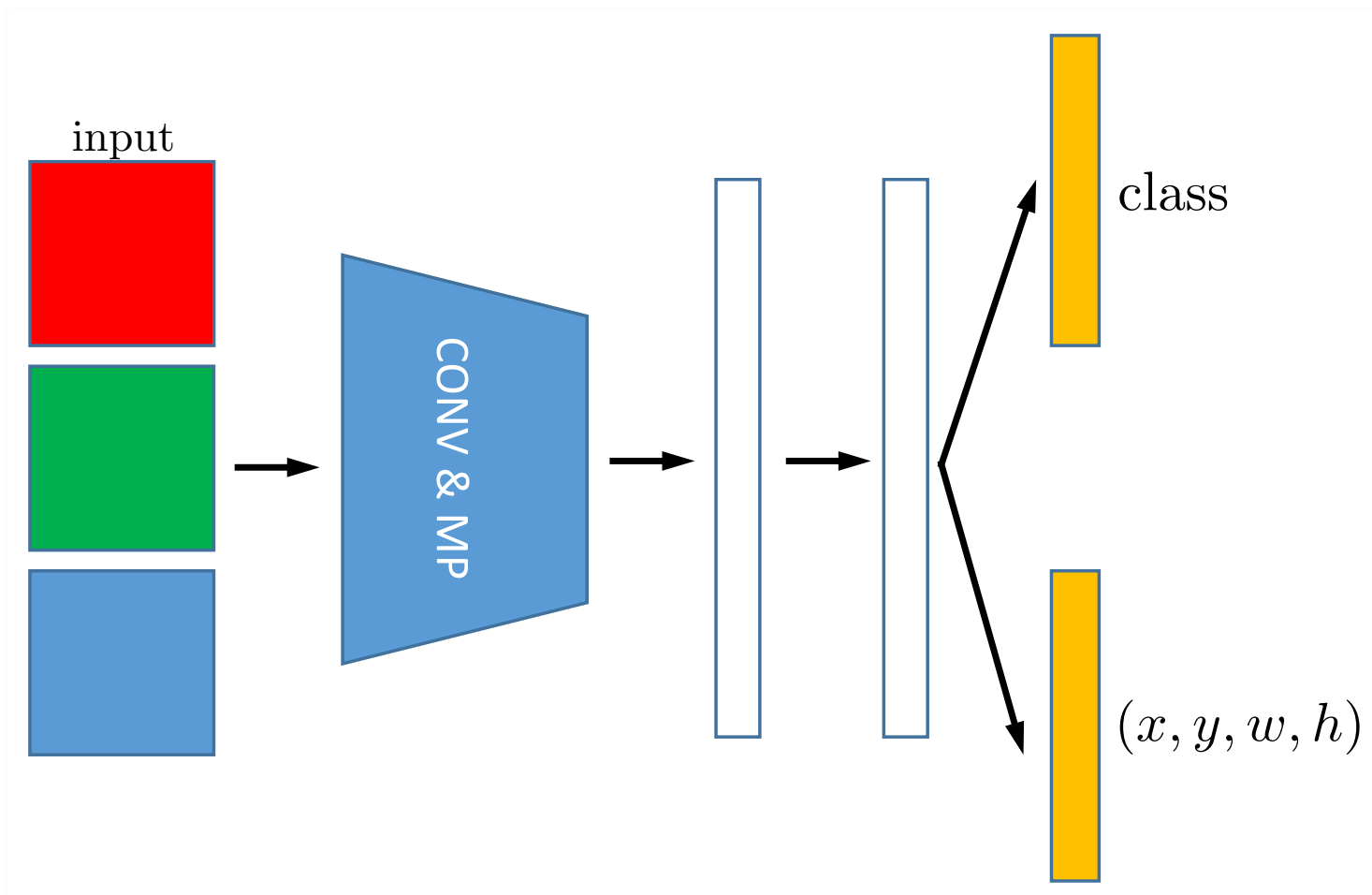

## Transfer Learning

- ◆ Idea: use an existing model as a base to solve a *similar problem*
- ◆ Often used when not enough data available to solve the target problem directly
- ◆ Example: reuse an ImageNet network for object localization
- ◆ You can:
  - cut the original network at various layers,
  - fix or not the weights of the original network or use different *learning rates*
  - use different type of model instead of the output layers, e.g., linear SVM

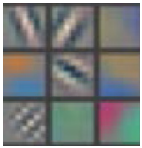

Layer 1

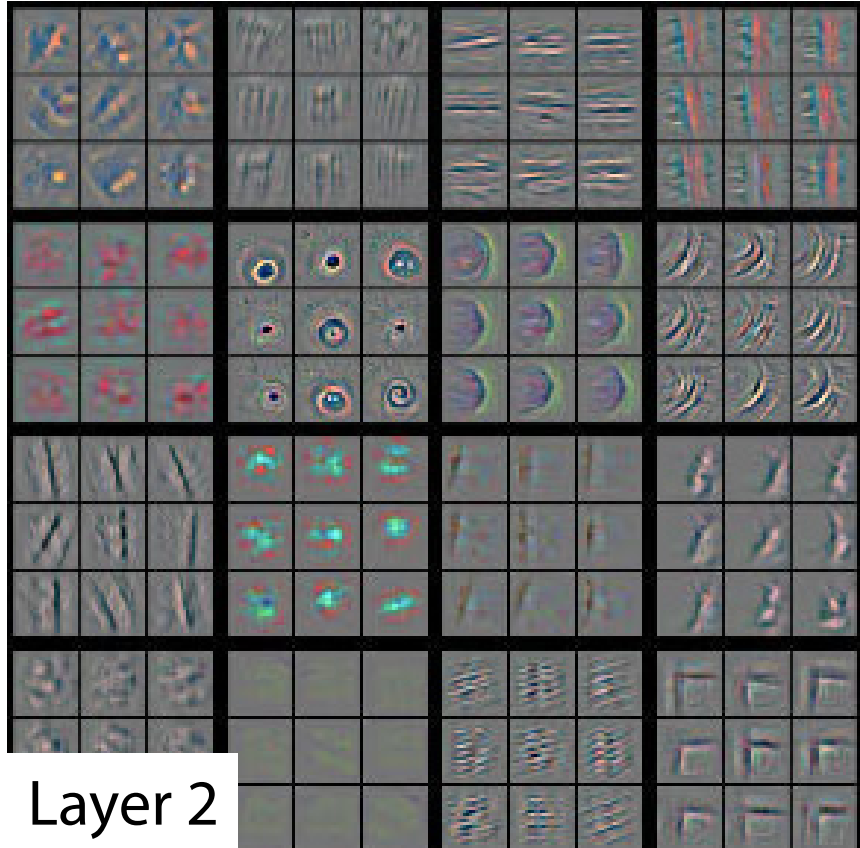
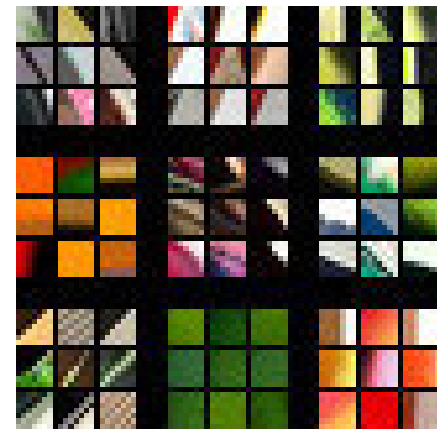

Layer 2

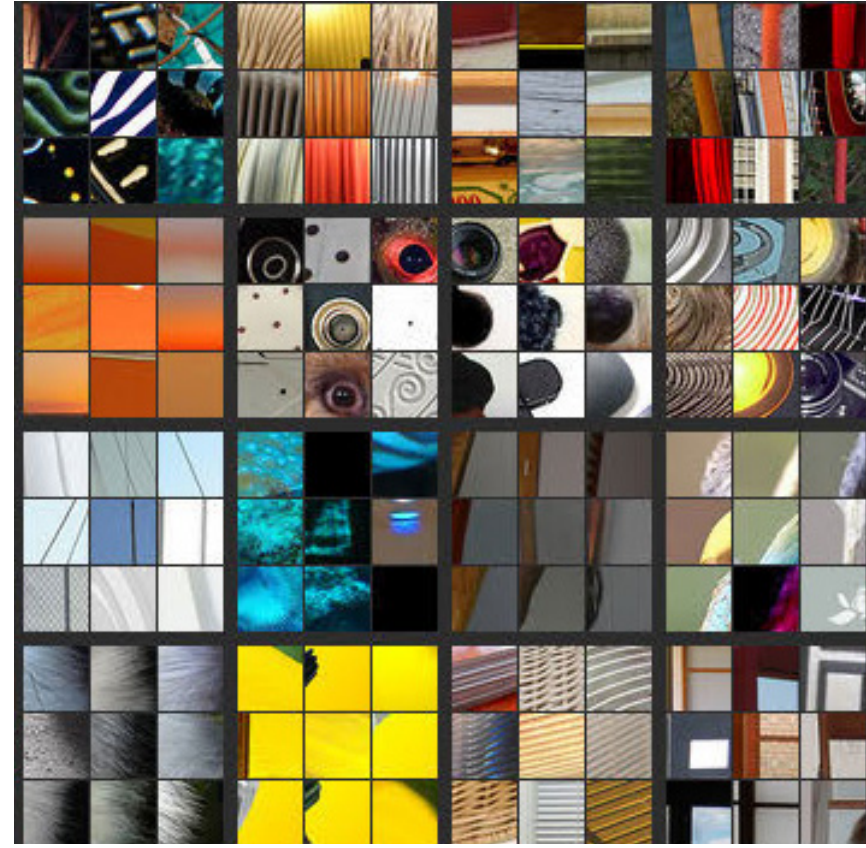

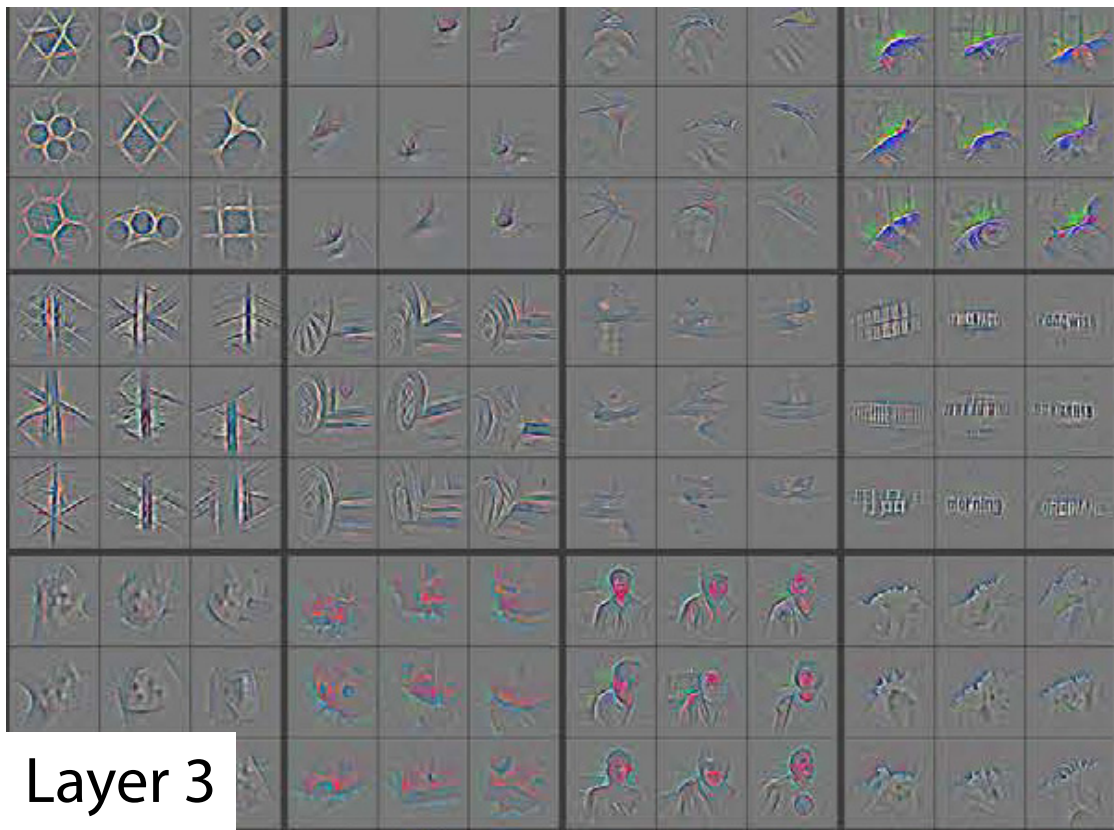

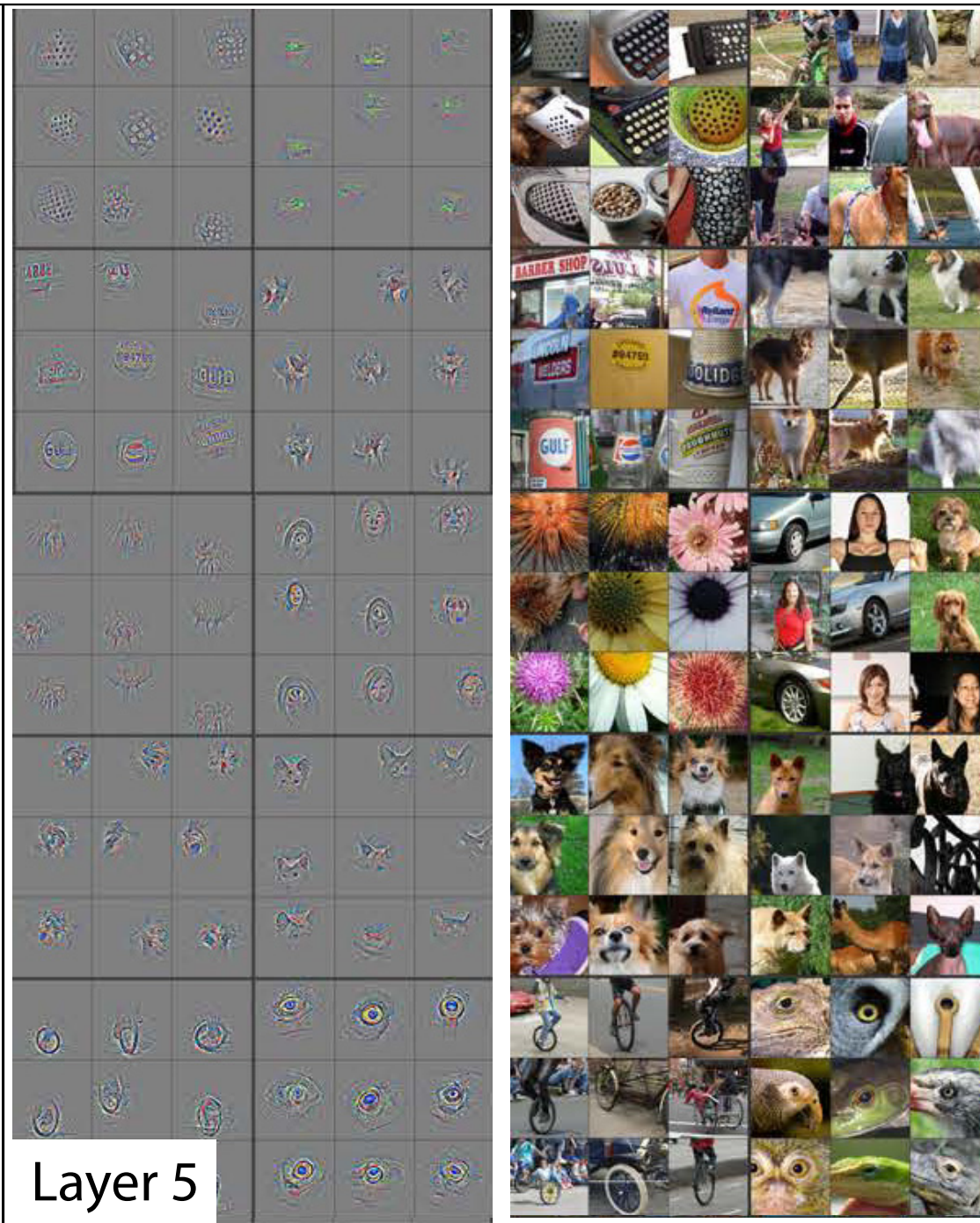
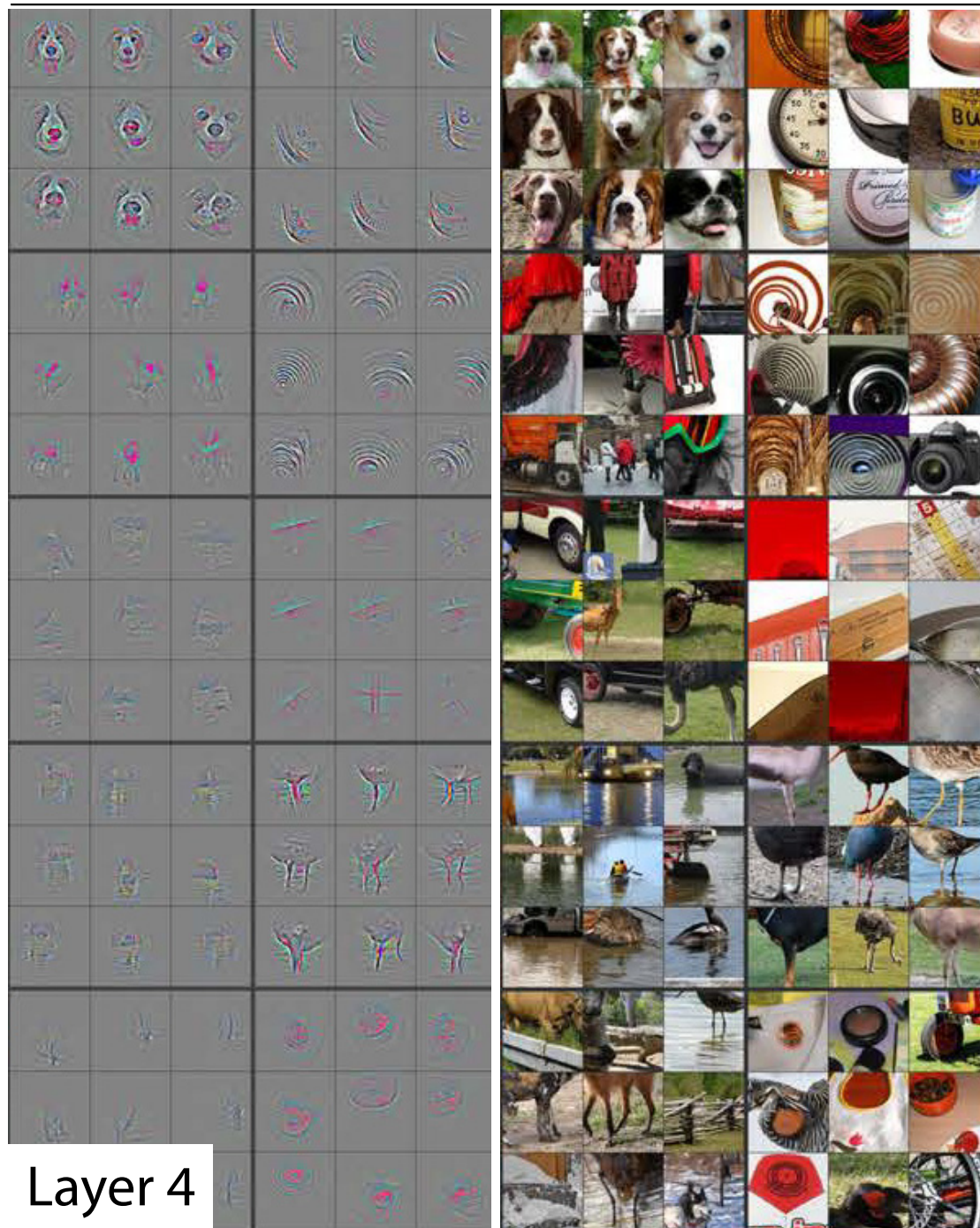

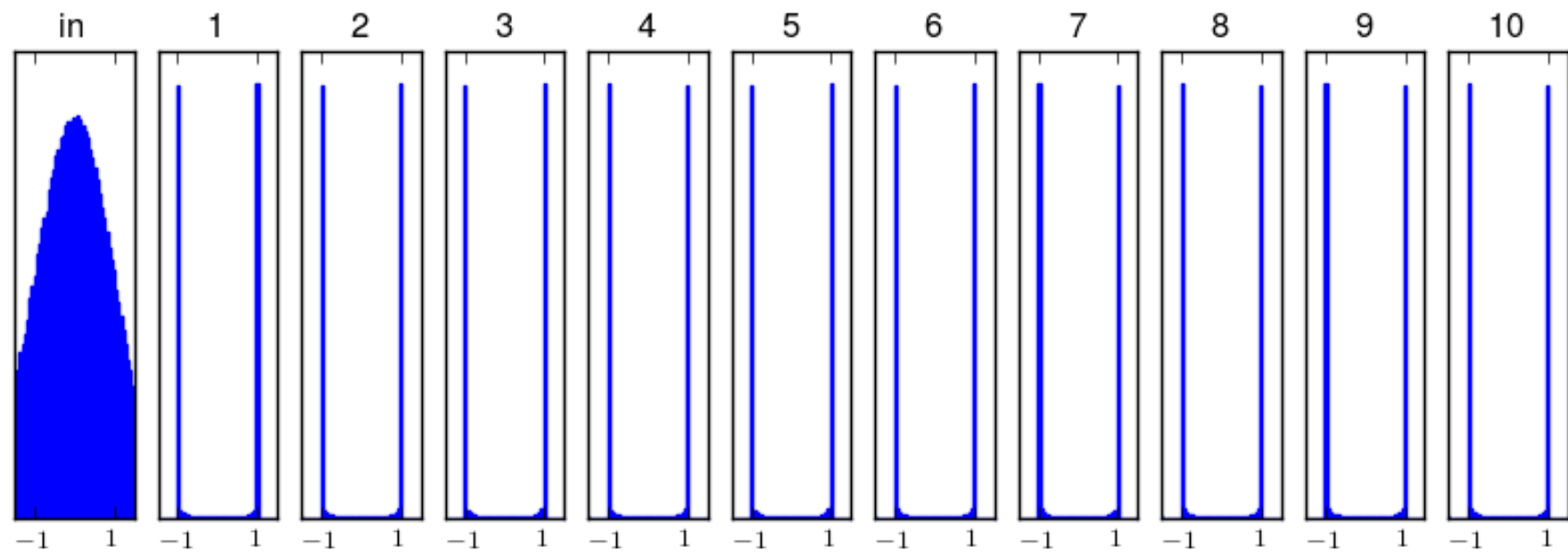



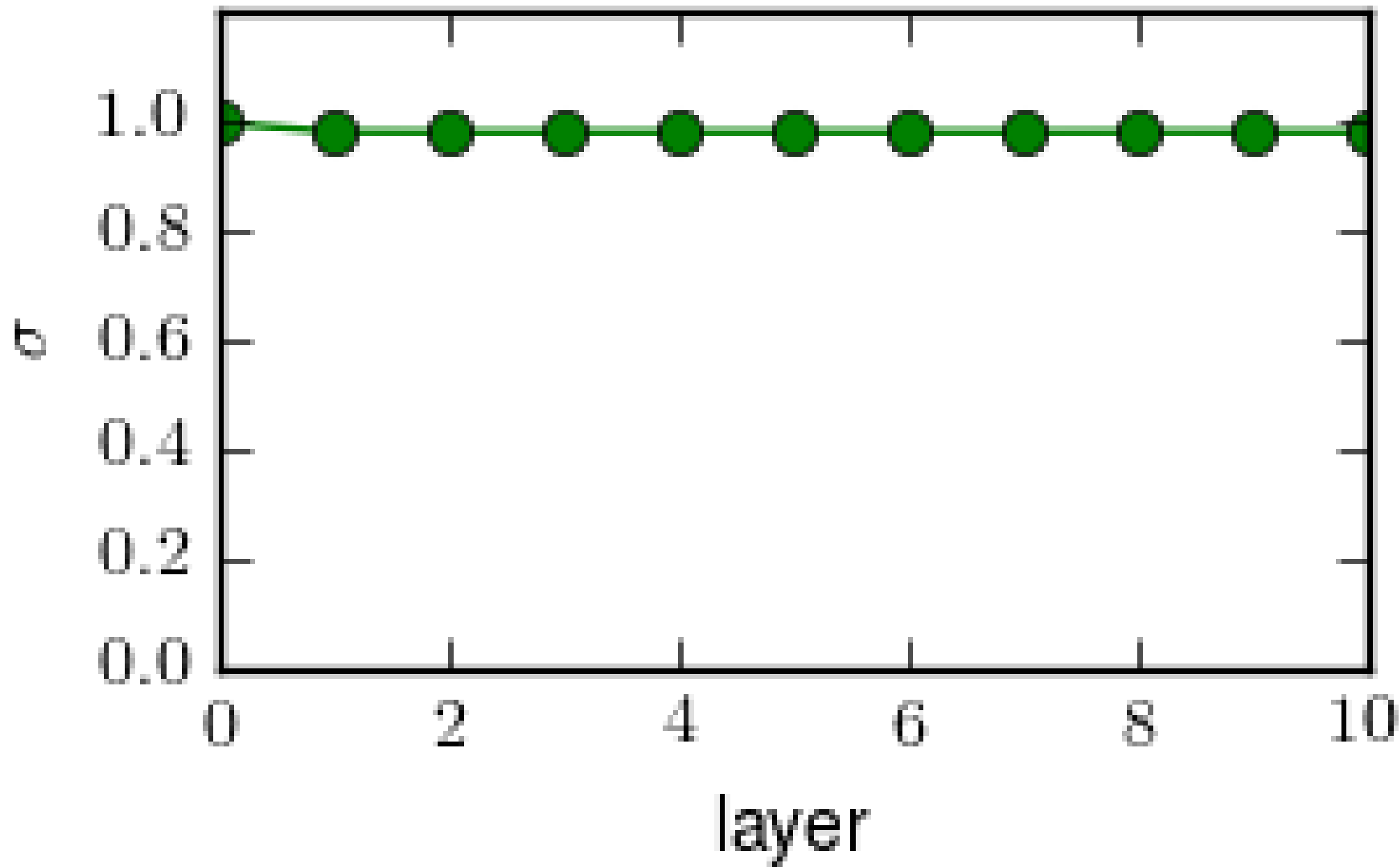

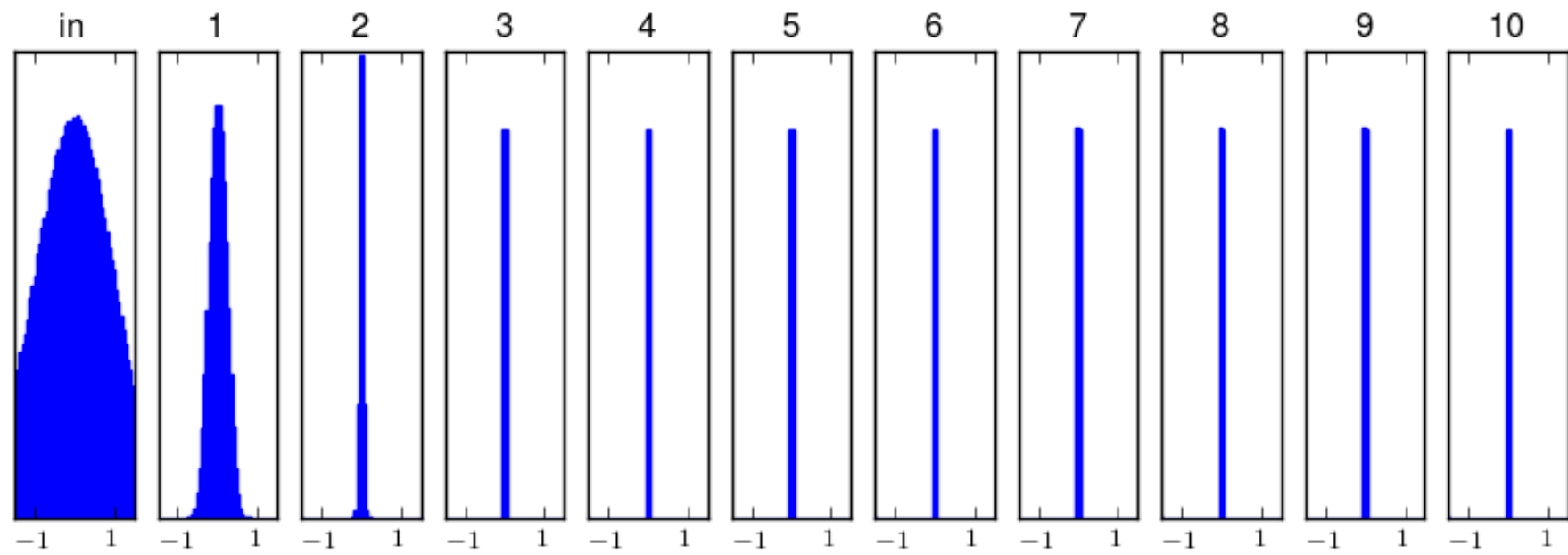

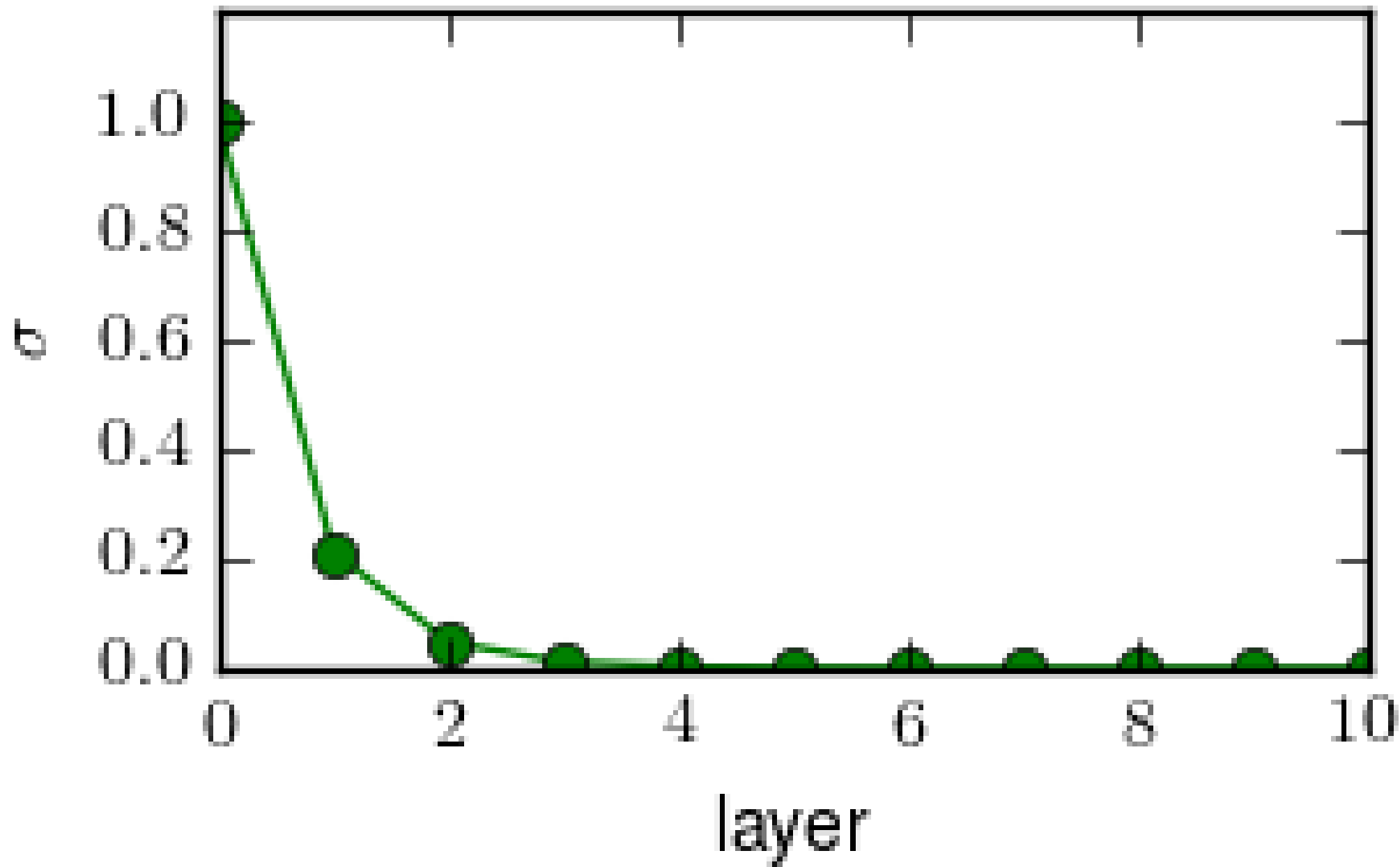

$\tanh(x)$

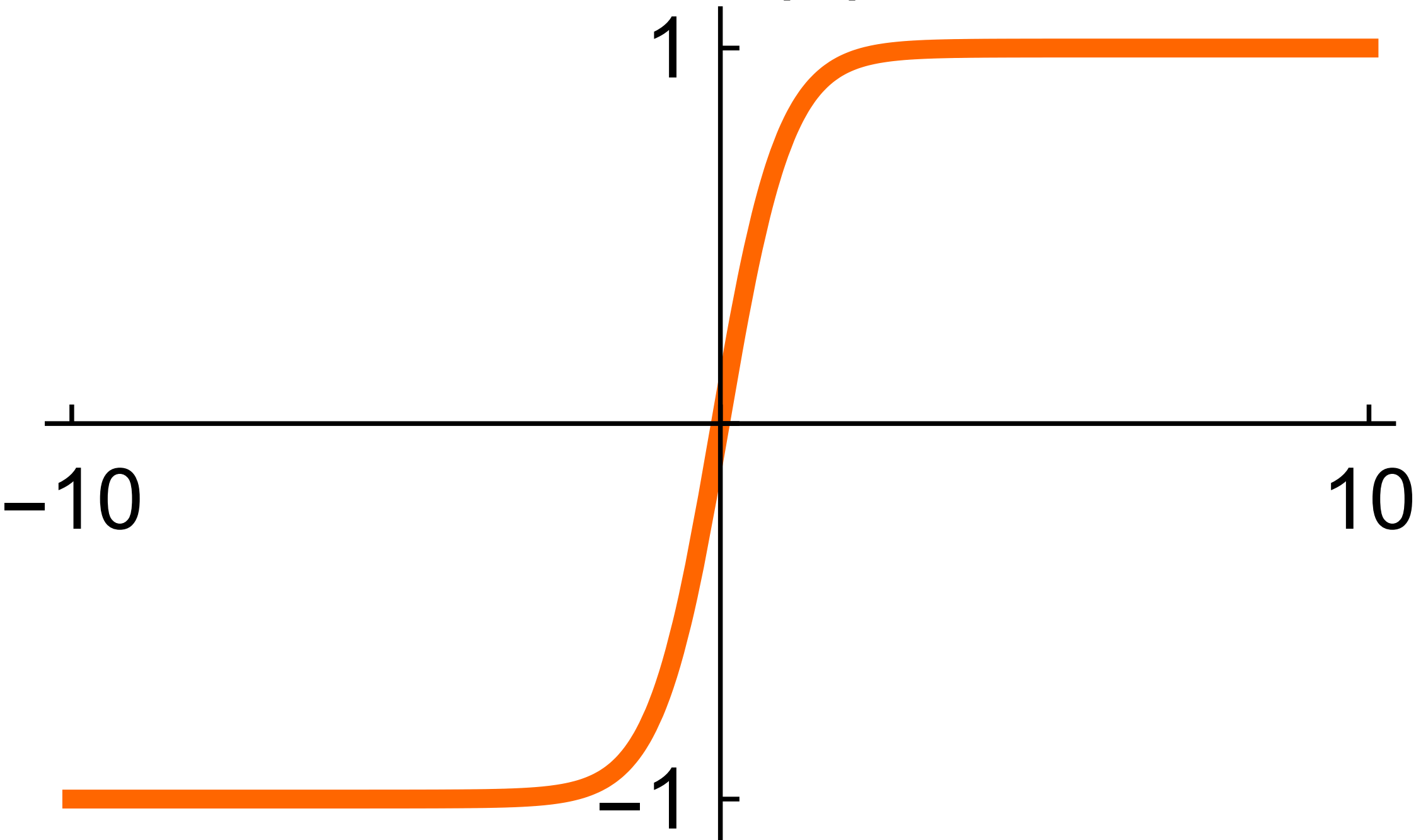

$\tanh'(x)$

1

-10

0

10

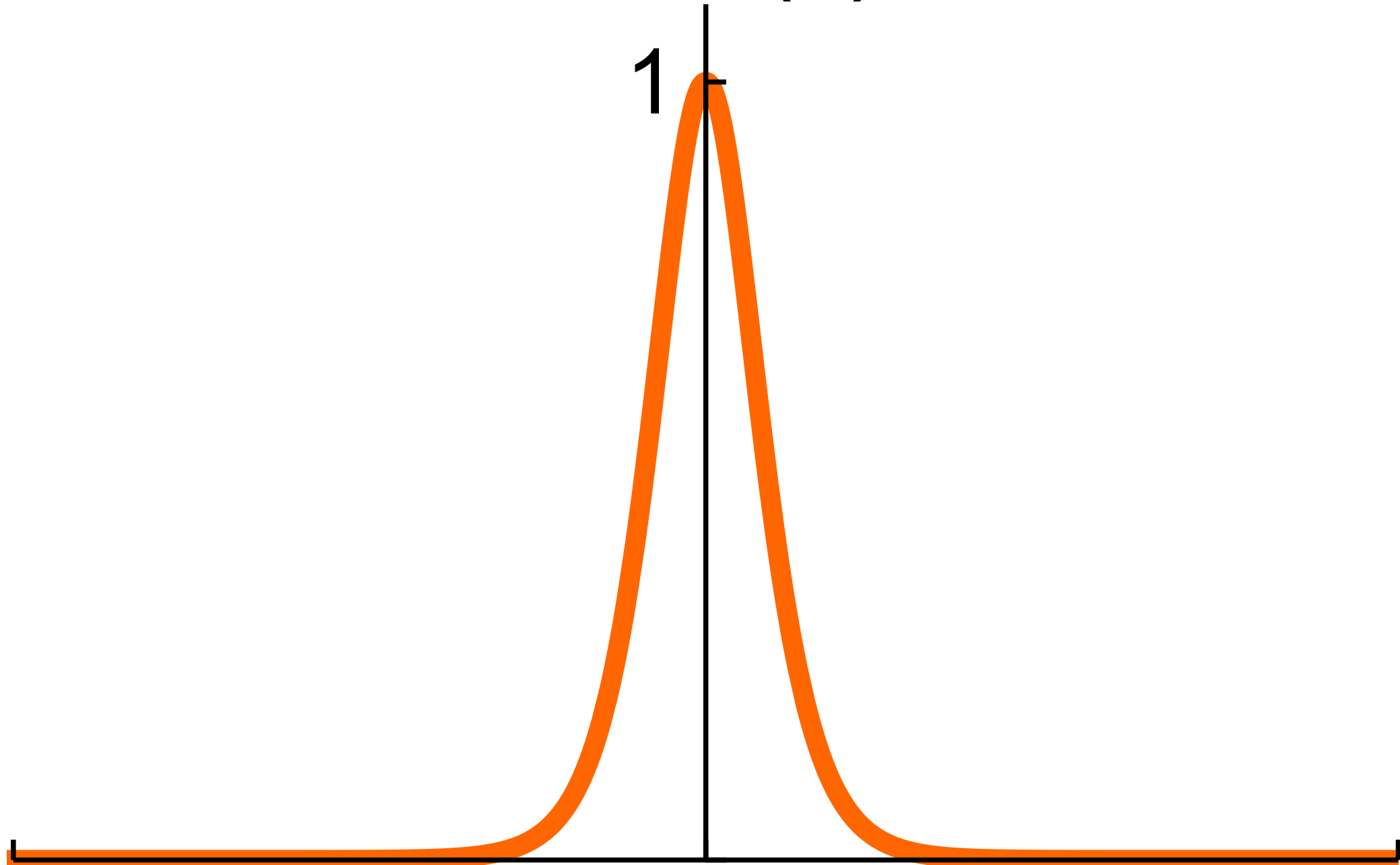

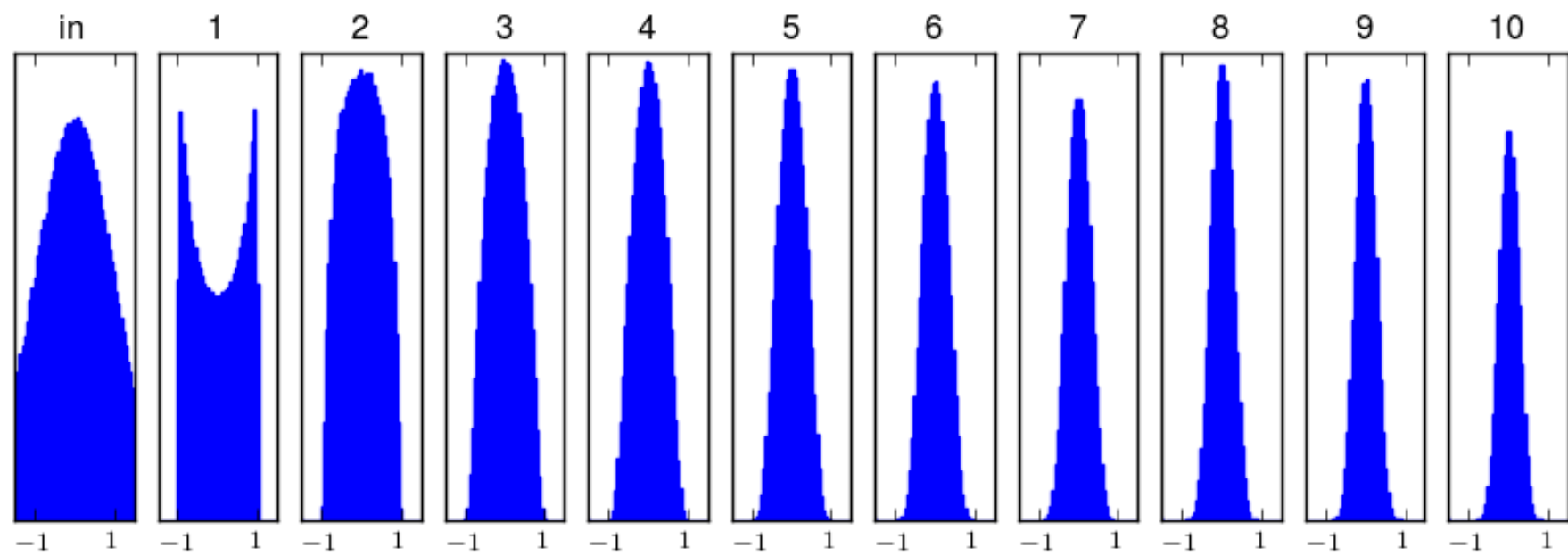

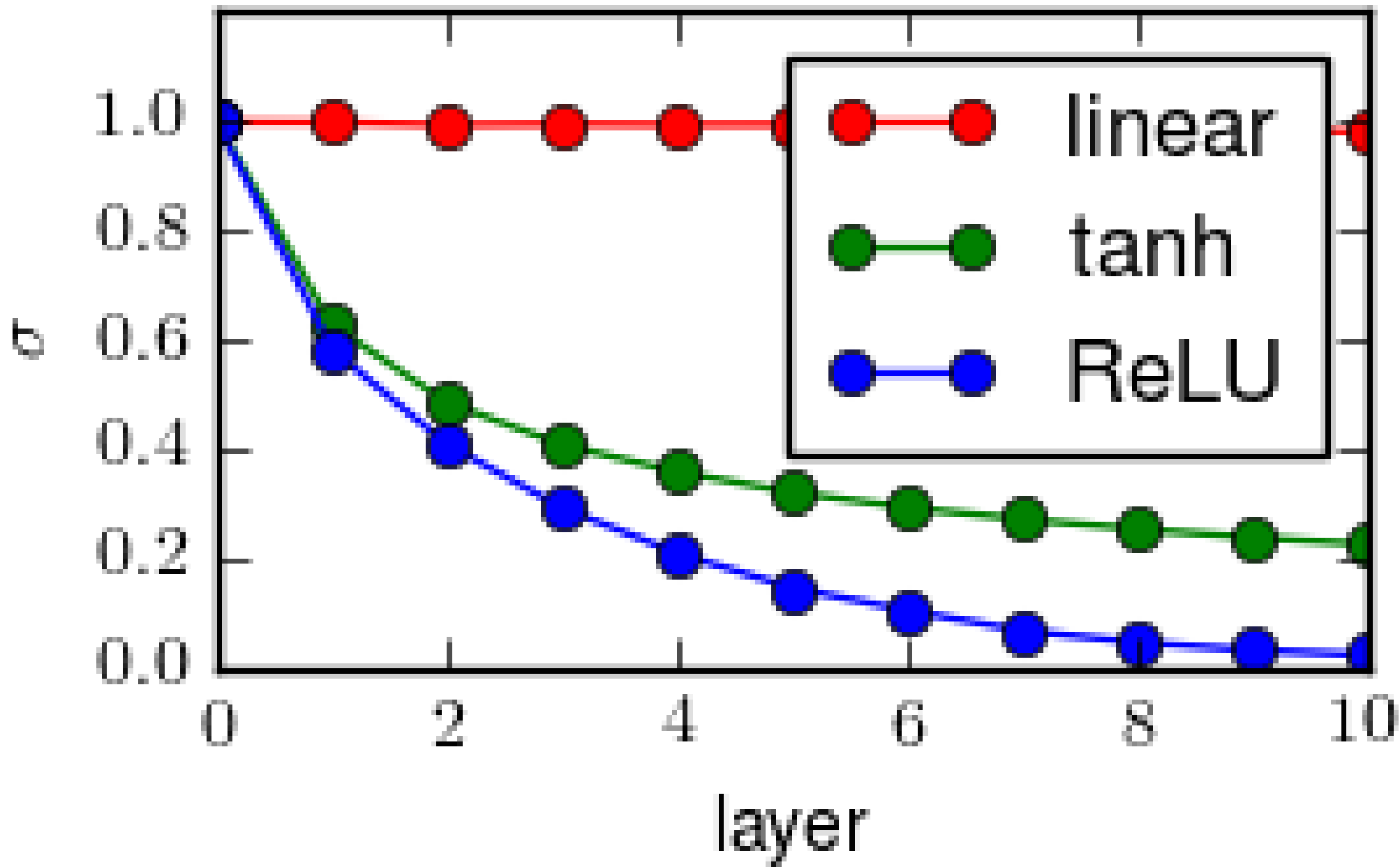

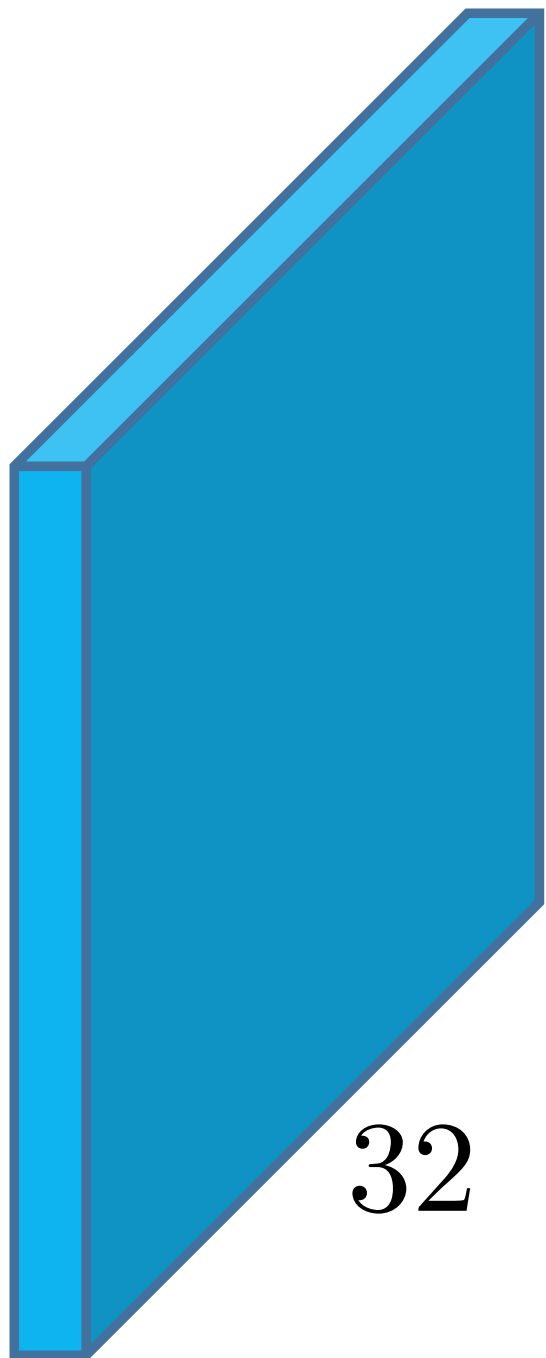

32

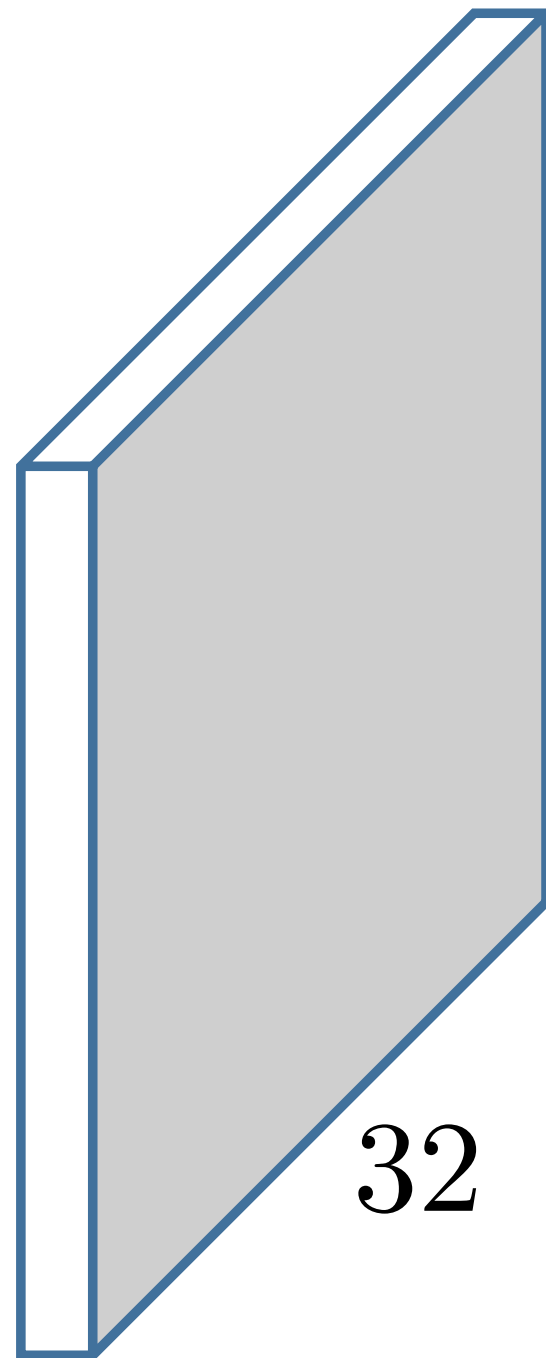

32

32



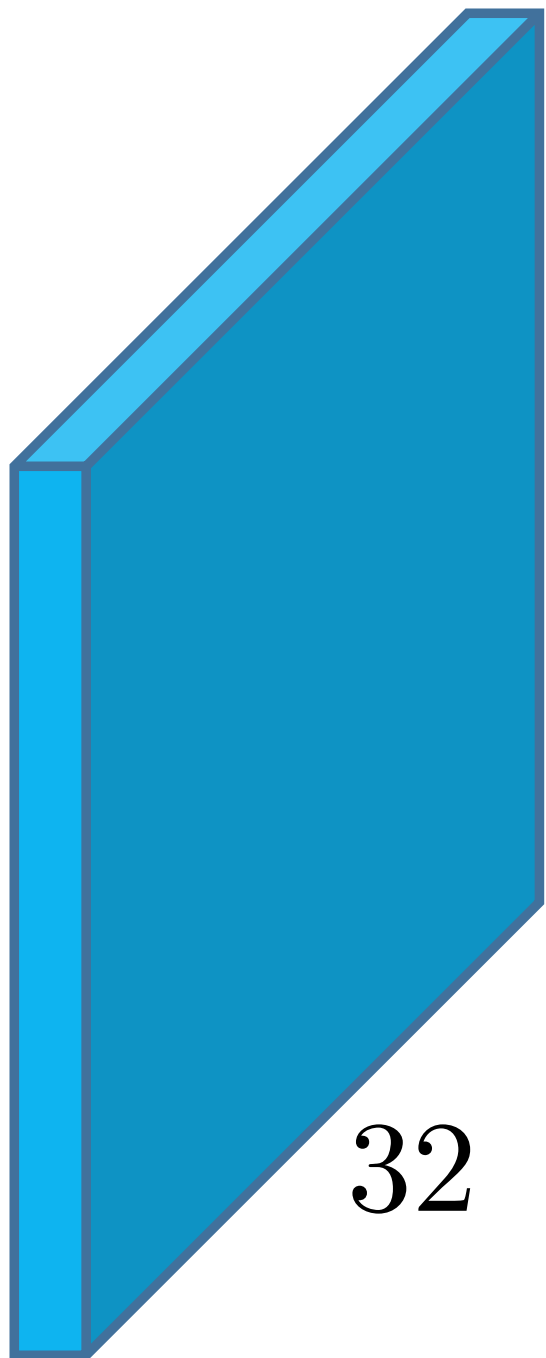

32

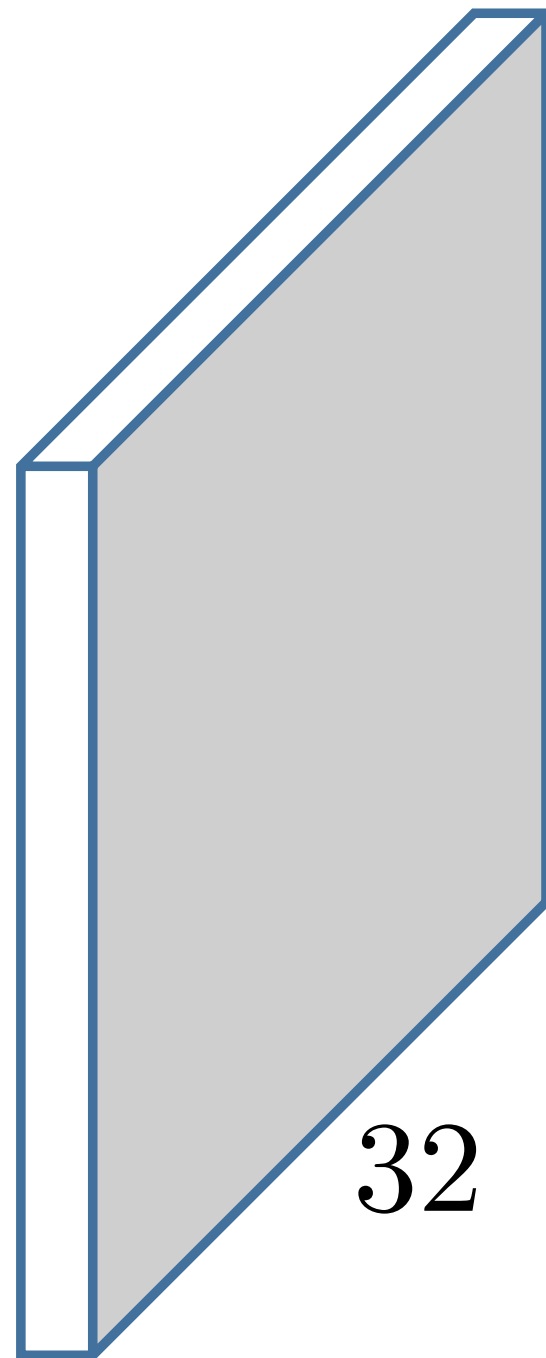

32

32

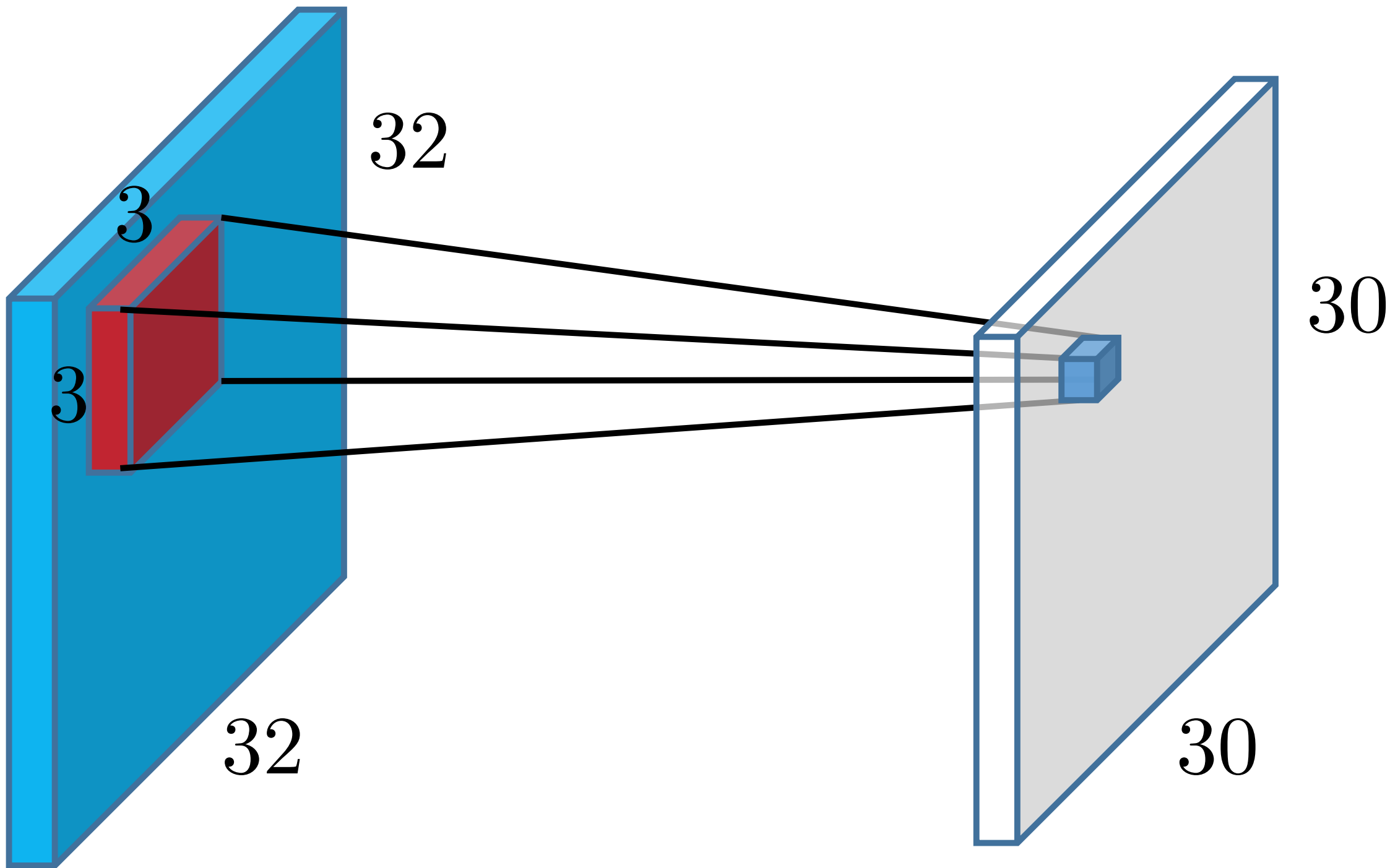

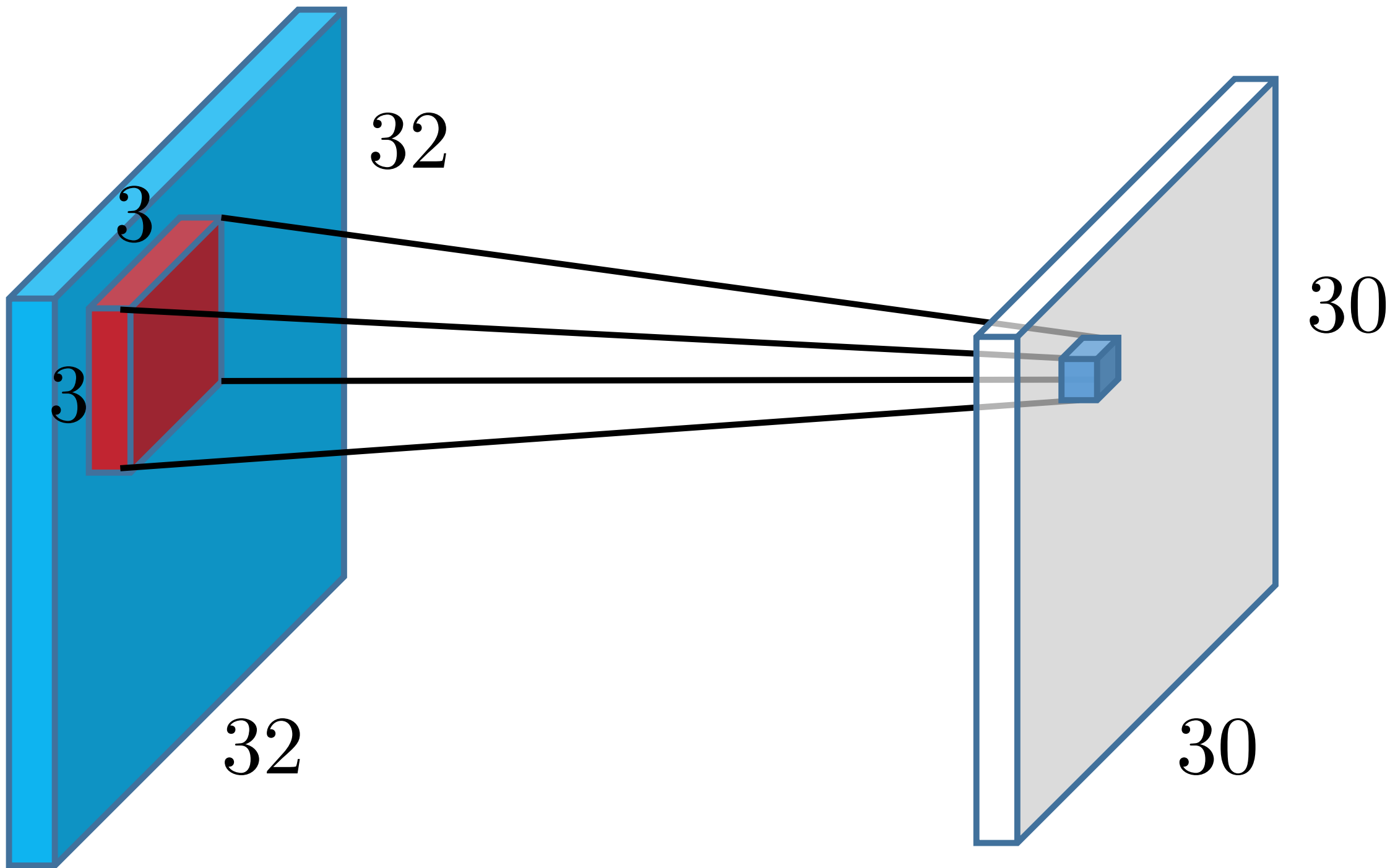

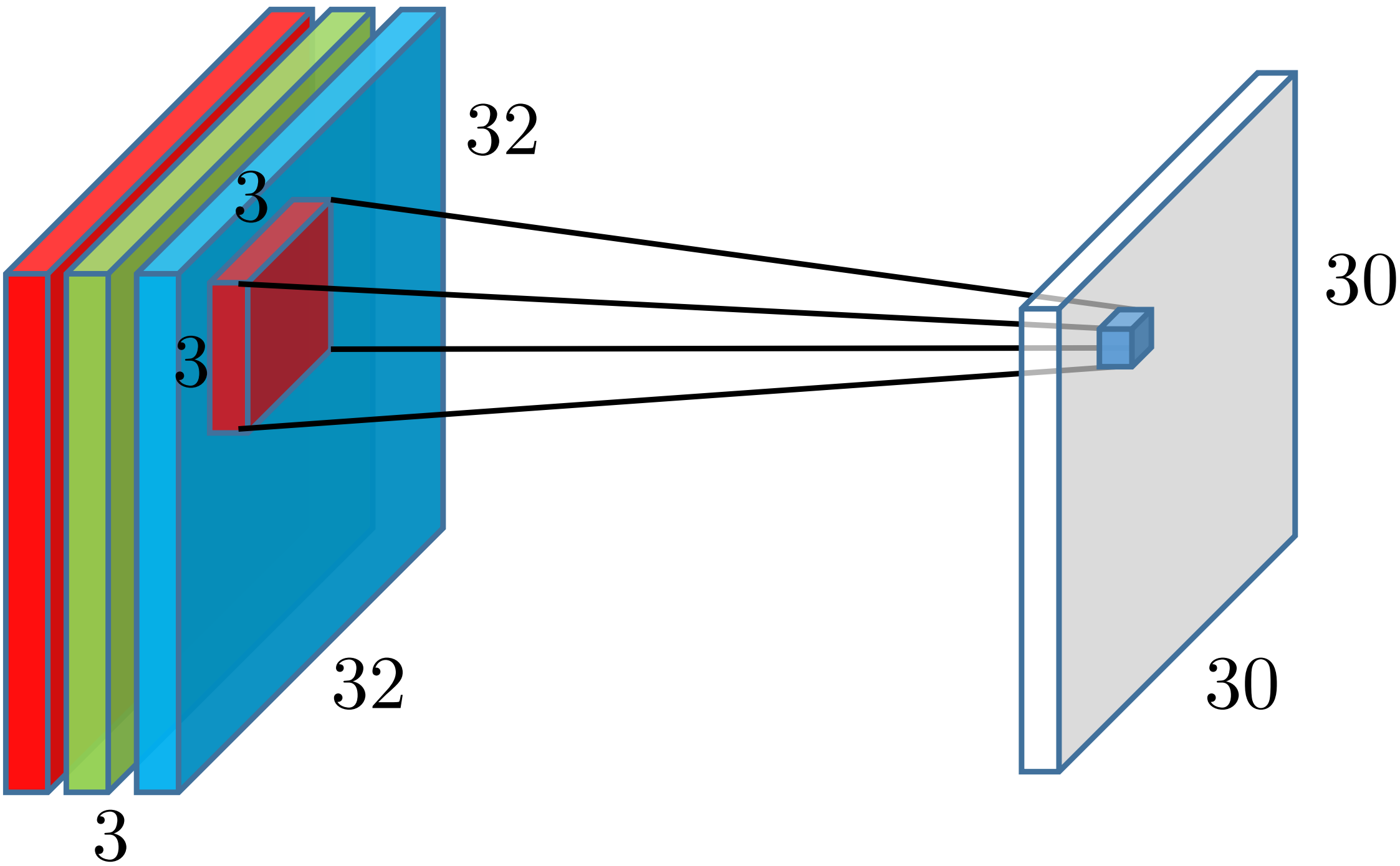

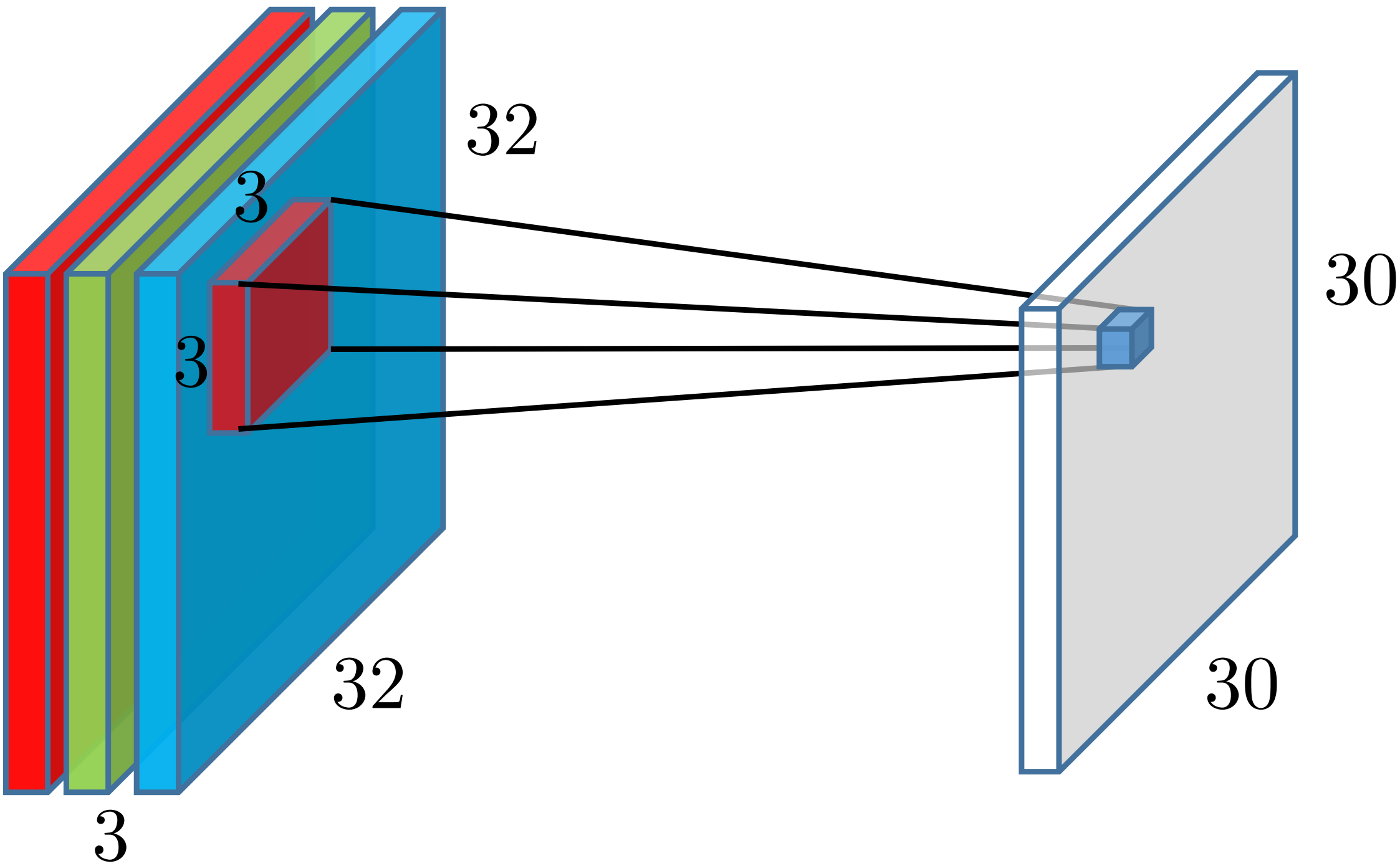

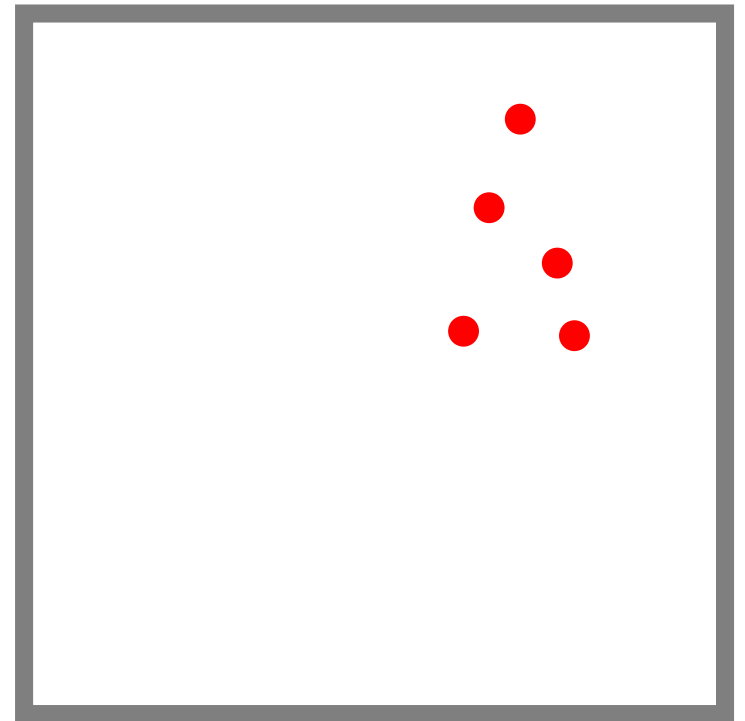
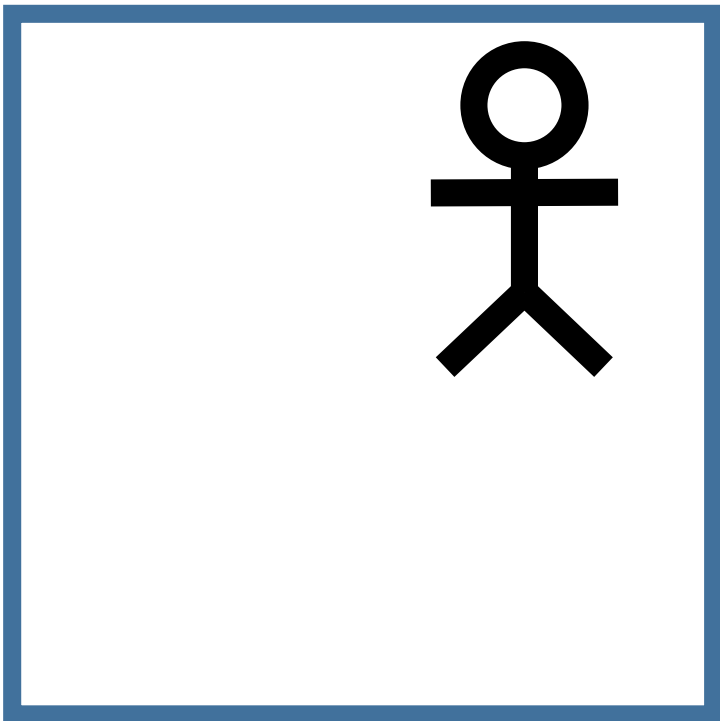
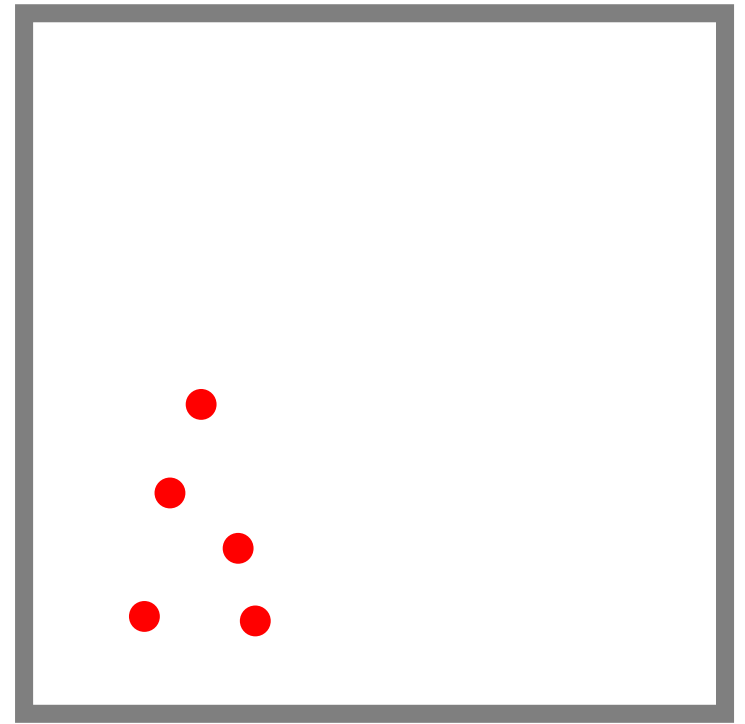
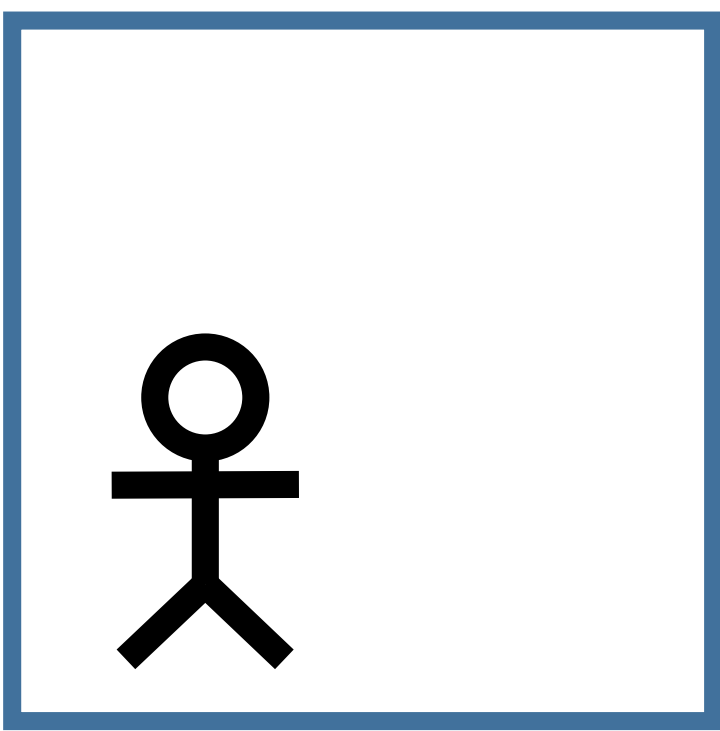

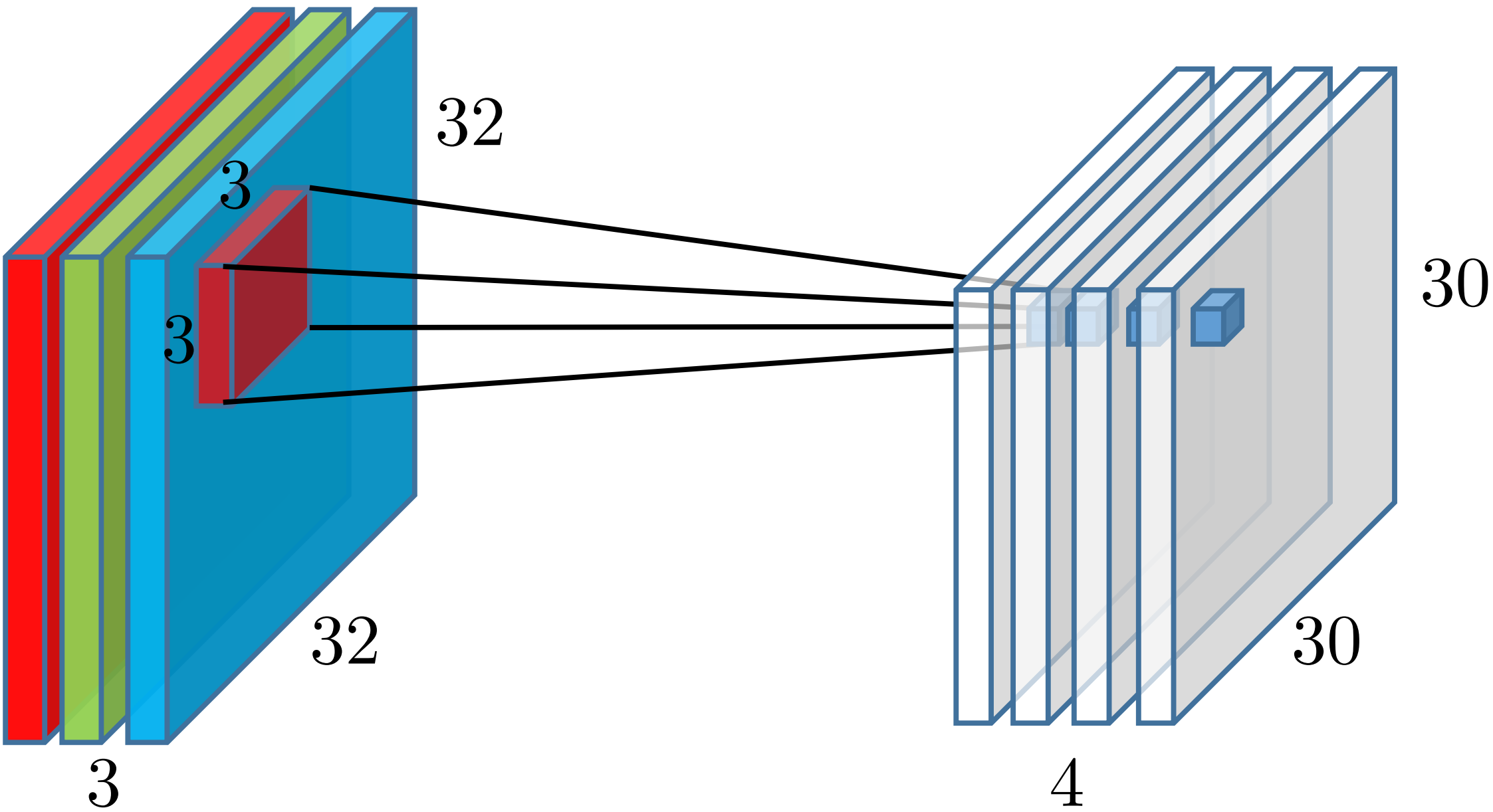

**Identity**

$$\begin{bmatrix} 0 & 0 & 0 \\ 0 & 1 & 0 \\ 0 & 0 & 0 \end{bmatrix}$$

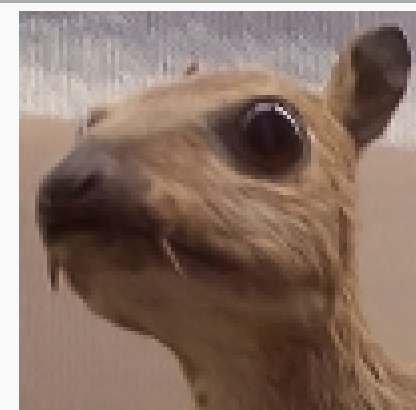

**Edge detection**

$$\begin{bmatrix} 1 & 0 & -1 \\ 0 & 0 & 0 \\ -1 & 0 & 1 \end{bmatrix}$$



$$\begin{bmatrix} 0 & 1 & 0 \\ 1 & -4 & 1 \\ 0 & 1 & 0 \end{bmatrix}$$

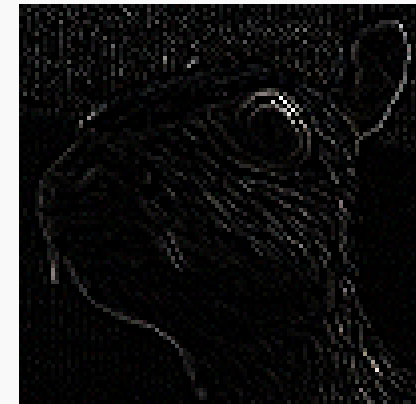

$$\begin{bmatrix} -1 & -1 & -1 \\ -1 & 8 & -1 \\ -1 & -1 & -1 \end{bmatrix}$$

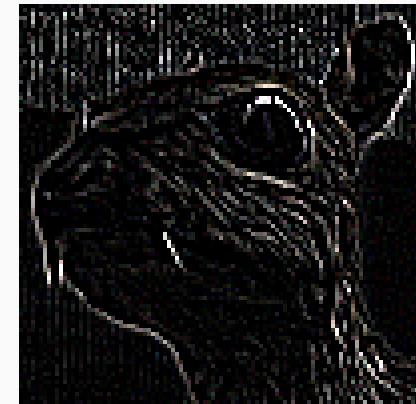



<p><b>Sharpen</b></p>	$\begin{bmatrix} 0 & -1 & 0 \\ -1 & 5 & -1 \\ 0 & -1 & 0 \end{bmatrix}$	
<p><b>Box blur</b> (normalized)</p>	$\frac{1}{9} \begin{bmatrix} 1 & 1 & 1 \\ 1 & 1 & 1 \\ 1 & 1 & 1 \end{bmatrix}$	
<p><b>Gaussian blur</b> (approximation)</p>	$\frac{1}{16} \begin{bmatrix} 1 & 2 & 1 \\ 2 & 4 & 2 \\ 1 & 2 & 1 \end{bmatrix}$	

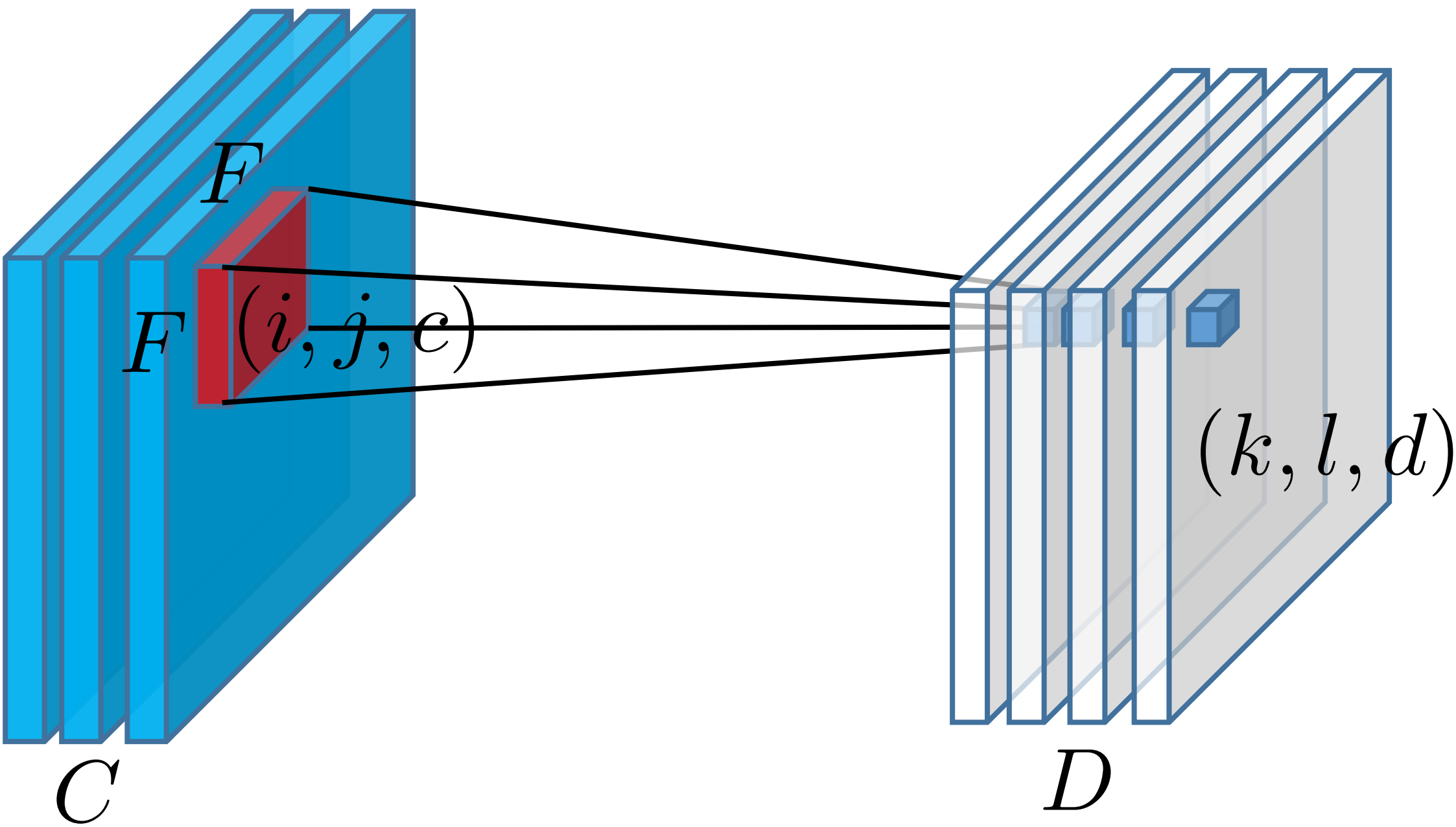

$S = 1$

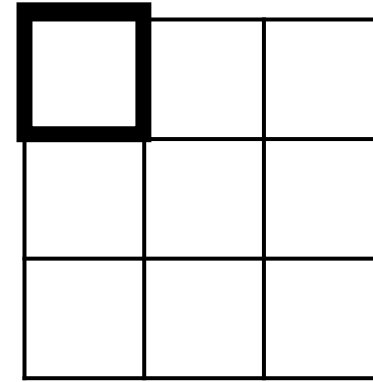
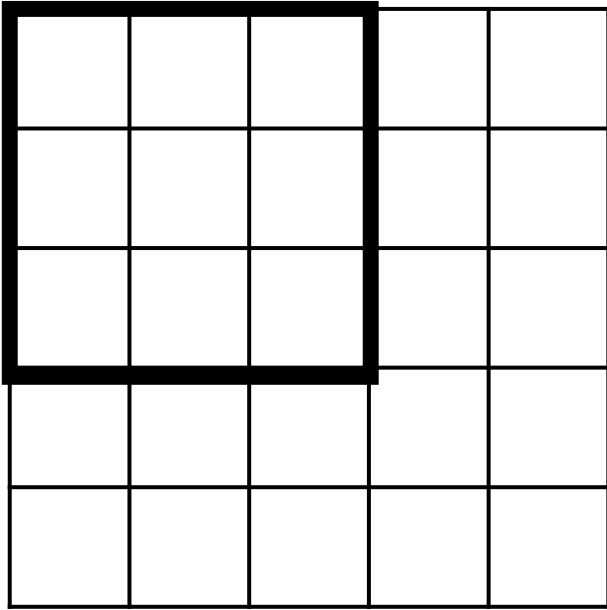

$S = 2$

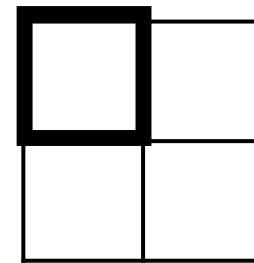
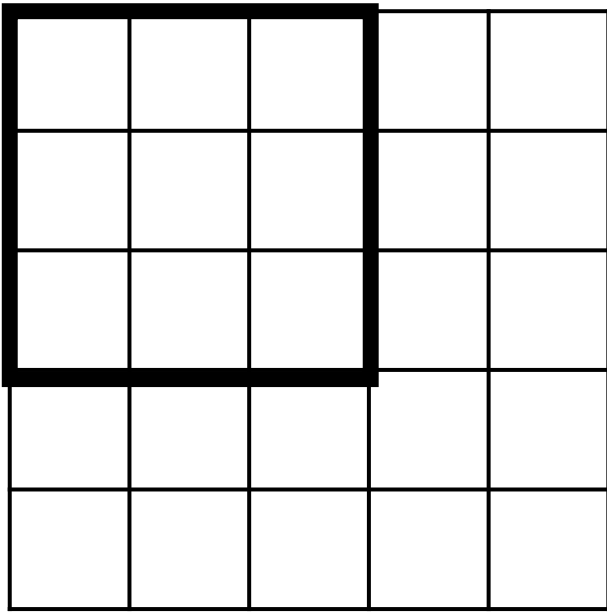

$S = 1$

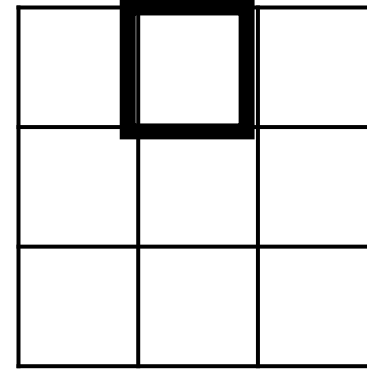
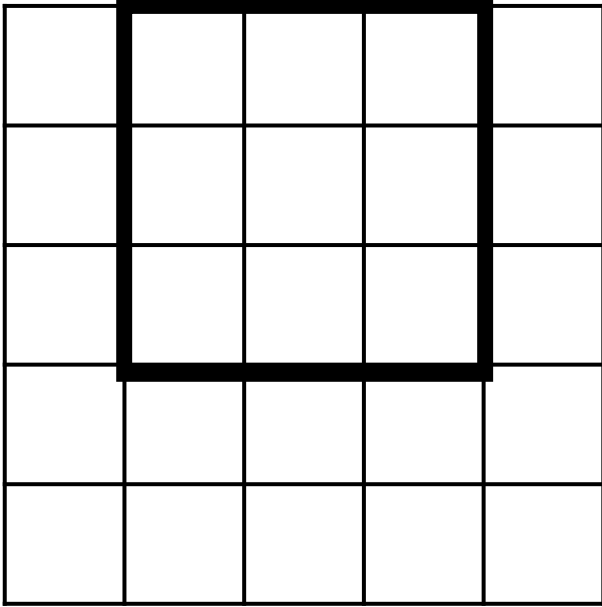

$S = 2$

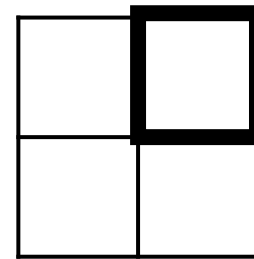
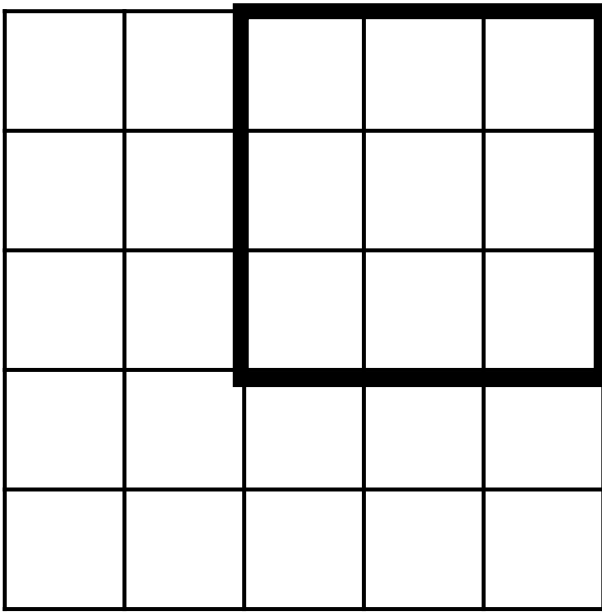



Input feature map

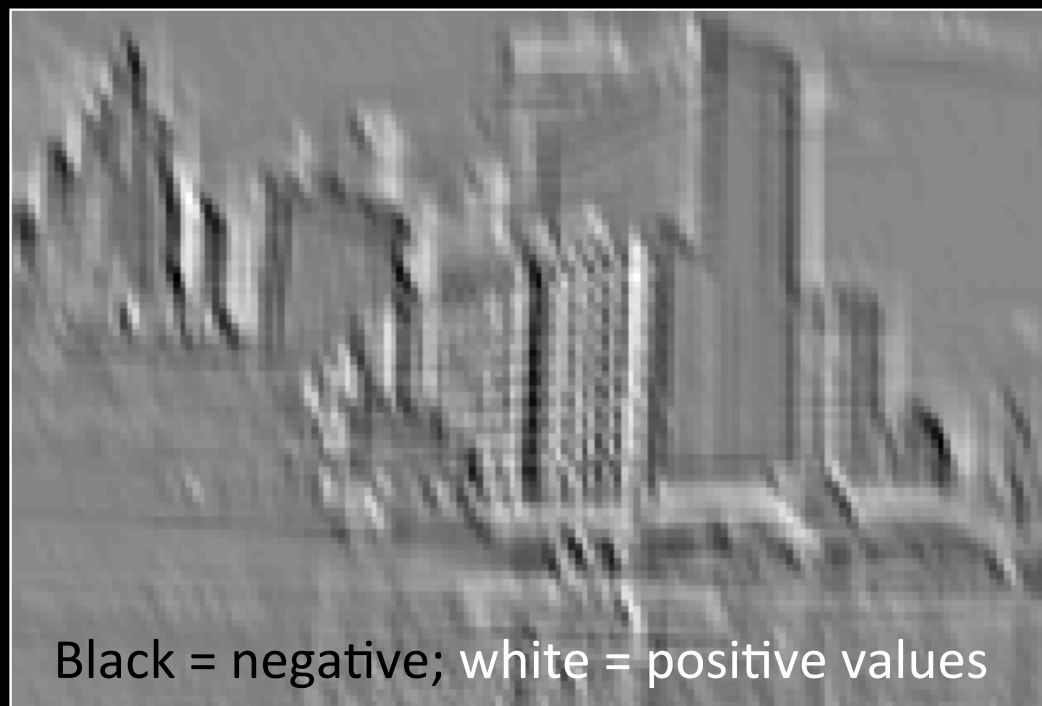

Output feature map



$$F = 2, S = 2$$

2	2	0	4	3	4
0	0	5	0	4	1
4	5	2	5	1	4
5	2	1	0	2	1
2	3	3	3	5	3
0	3	0	4	0	1



2	5	4
5	5	4
3	4	5

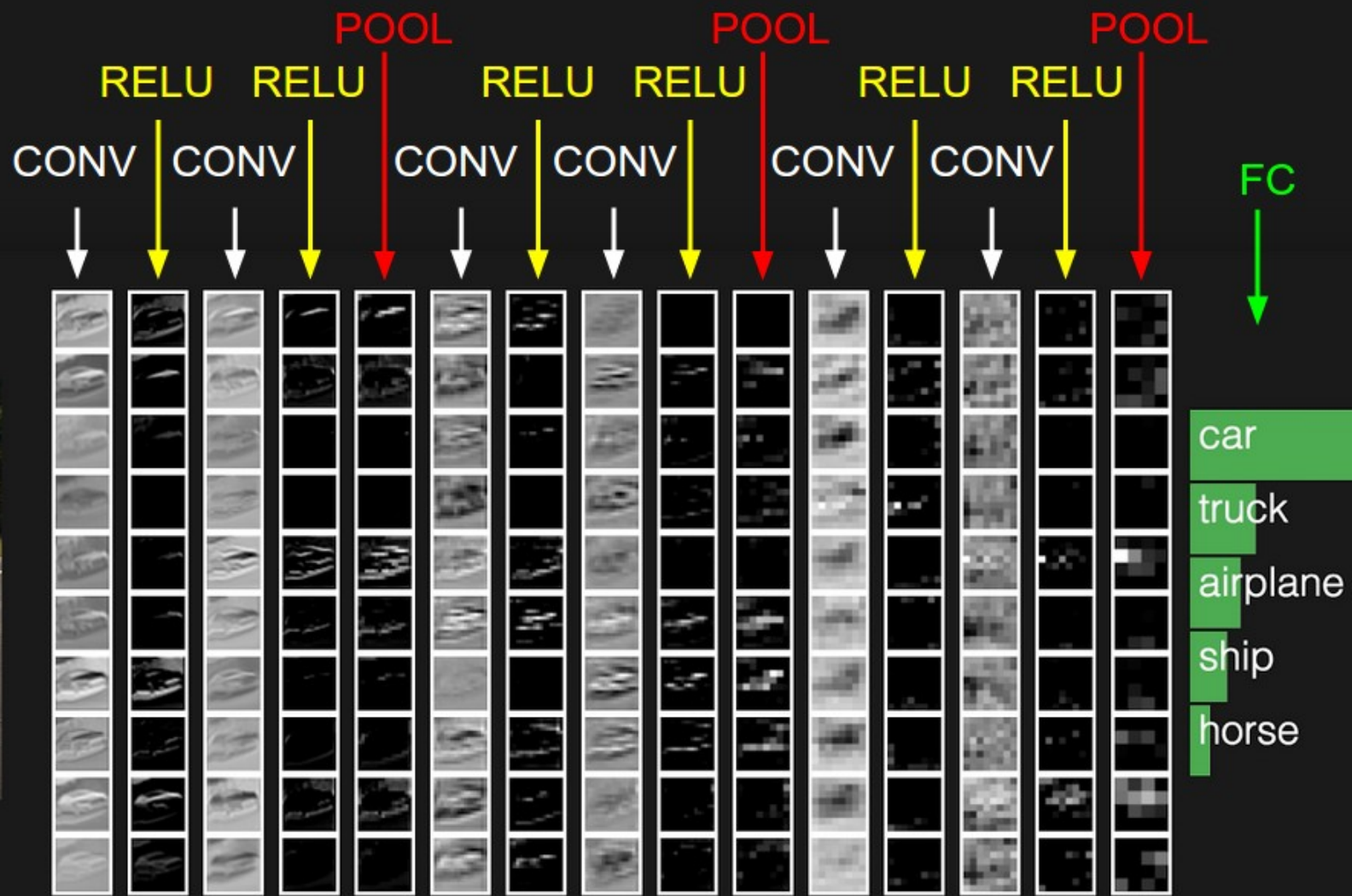



	input	conv3-64	conv3-64	MP	conv3-128	conv3-128	MP	conv3-256	conv3-256	conv3-256	MP	conv3-512	conv3-512	conv3-512	MP	conv3-512	conv3-512	conv3-512	MP	FC - 4096	FC - 4096	FC - 1000	softmax
parameters		1.7k	37k		74k	147k		295k	590k	590k		1.2M	2.4M	2.4M		2.4M	2.4M	2.4M		<b>103M</b>	16.7M	4M	
activations	150k	<b>3.2M</b>	<b>3.2M</b>	800k	1.6M	1.6M	400k	800k	800k	800k	200k	400k	400k	400k	100k	100k	100k	100k	25k	4096	4096	1000	1000
	224 x 224 x 3	224 x 224 x 64		112 x 112 x 64	112 x 112 x 128		56 x 56 x 128	56 x 56 x 256			28 x 28 x 256	28 x 28 x 512			14 x 14 x 512	14 x 14 x 512			7 x 7 x 512	1 x 1 x 4096	1 x 1 x 4096	1 x 1 x 1000	

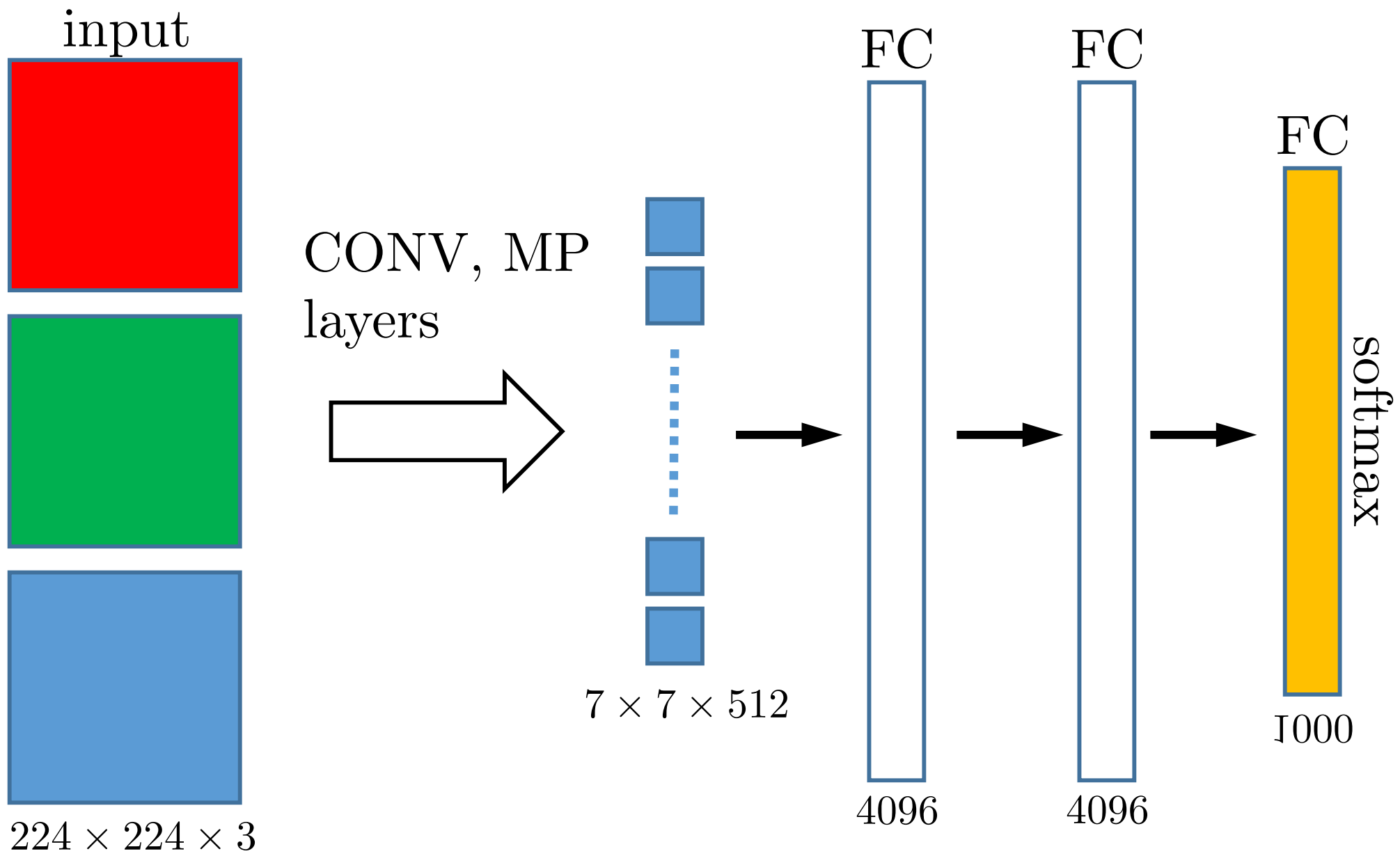

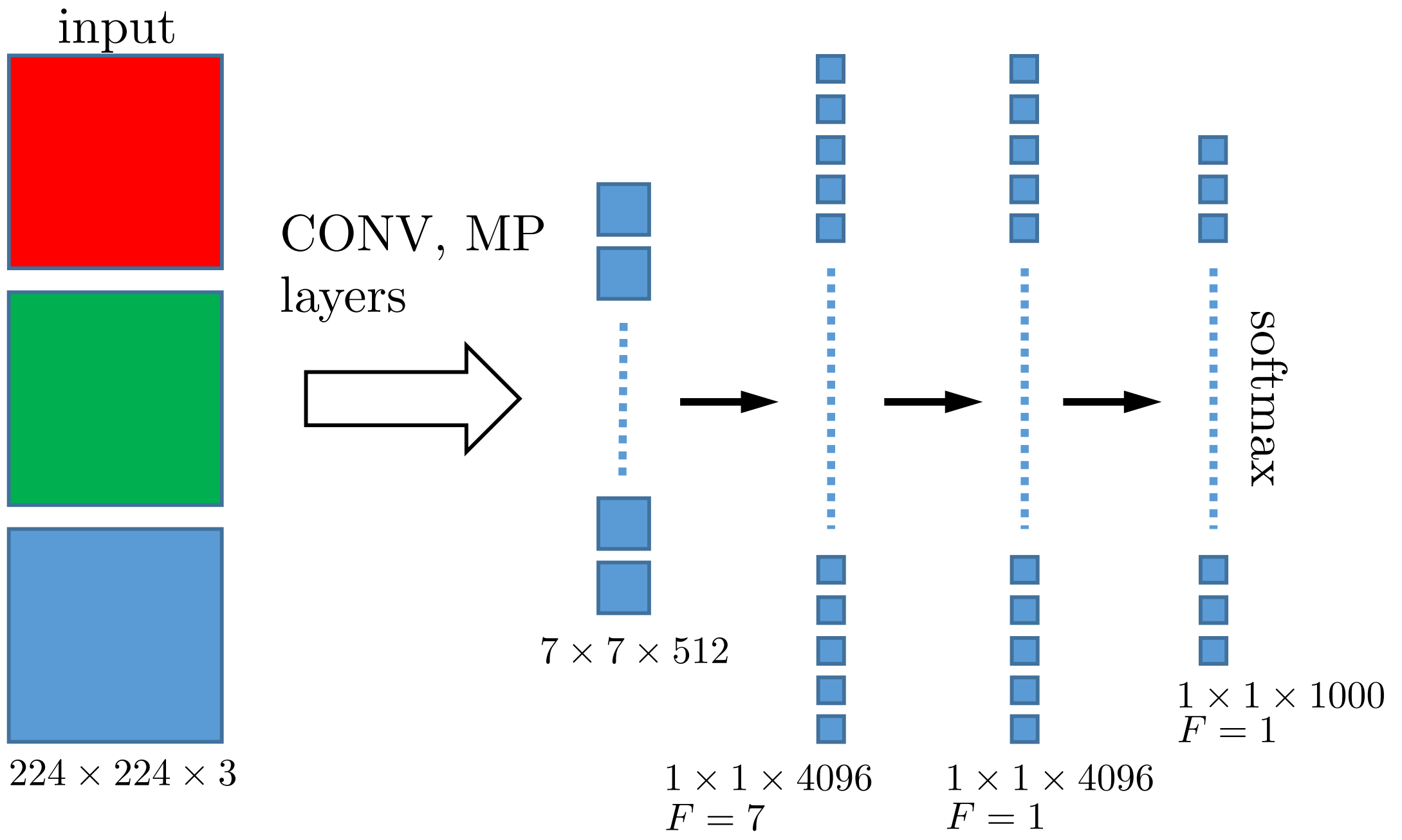



CONV, MP  
layers

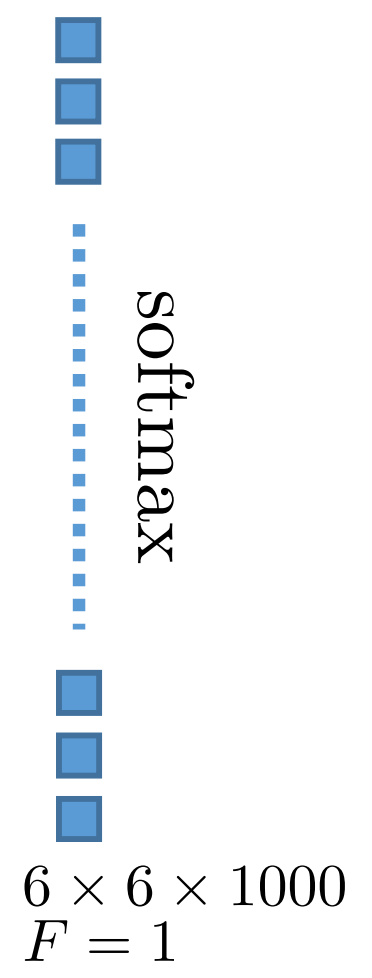
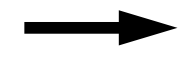
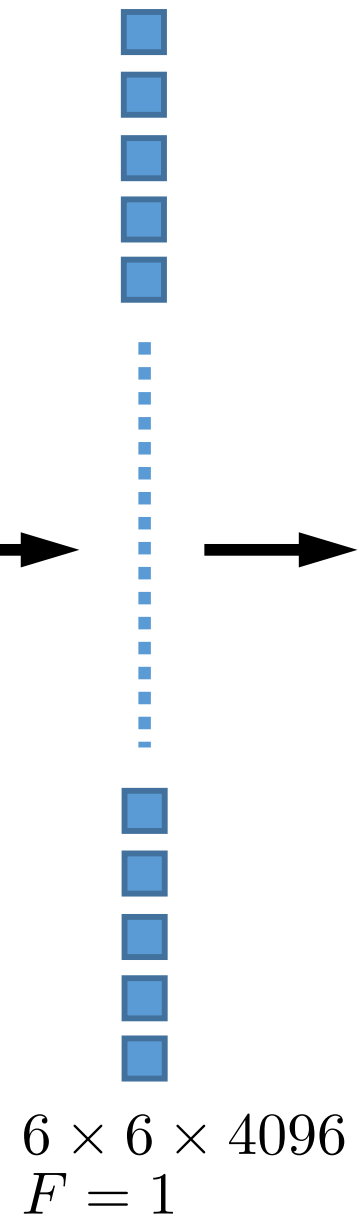
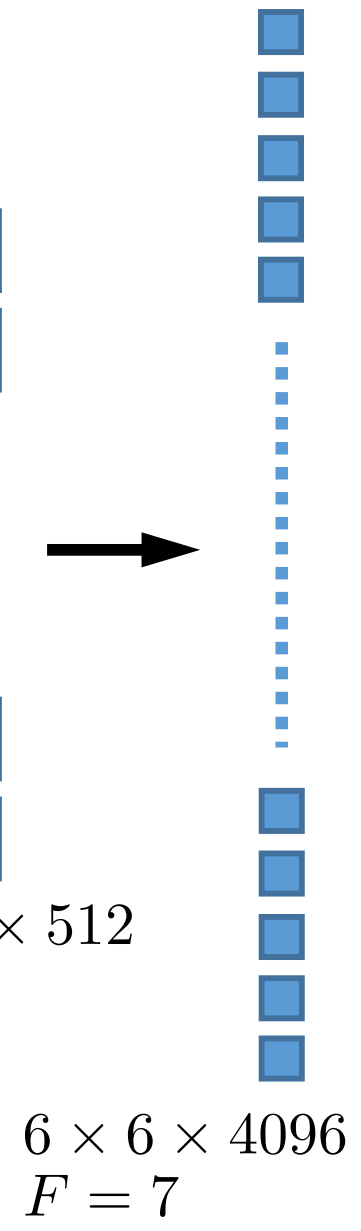
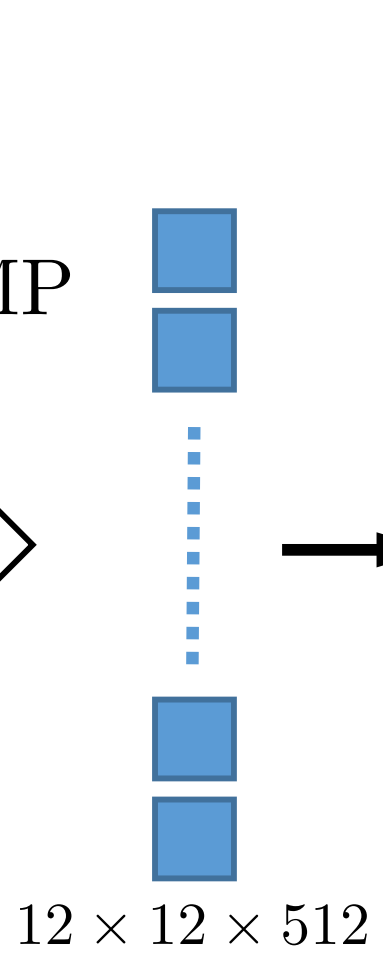
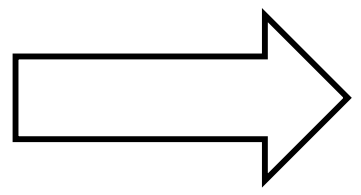



input

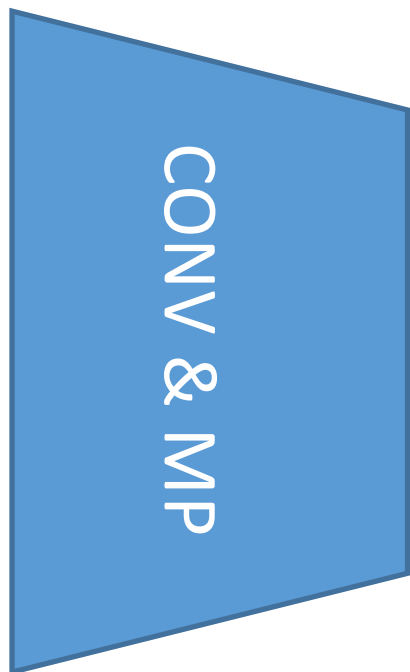
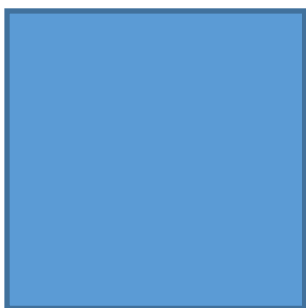
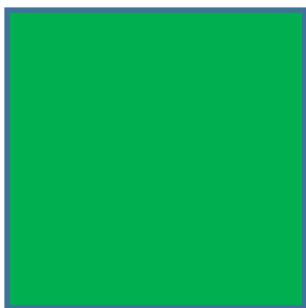
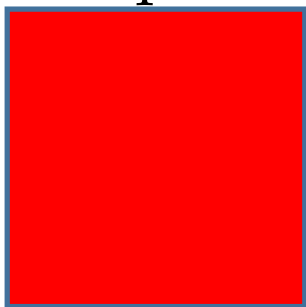

class



input

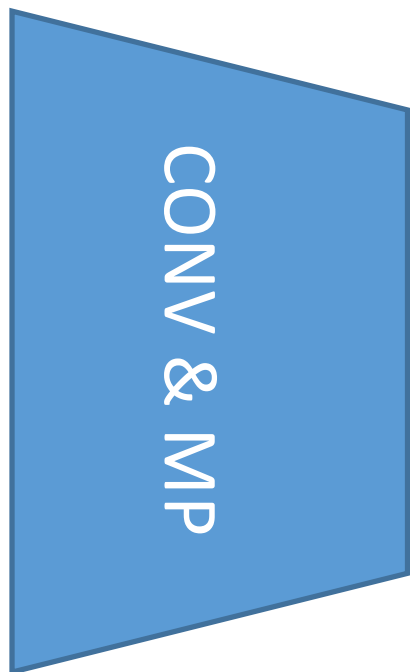
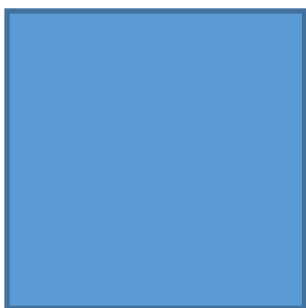
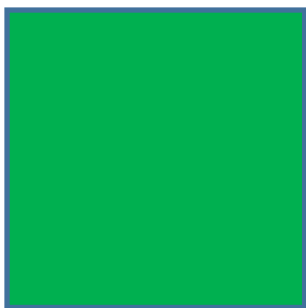
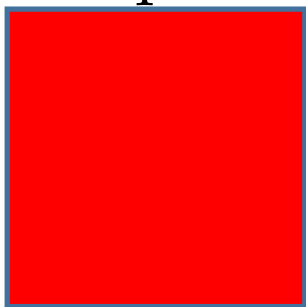

$(x, y, w, h)$





