

ALG 10

Dynamic programming

abbreviation: DP

Sources, overviews, examples see

<https://cw.fel.cvut.cz/wiki/courses/ae4b33alg/links>

Dynamic programming

**DP is a general strategy applicable to many different optimisation problems in diverse fields of computer science.
In this respect it is similar to Divide and conquer strategy.**

Important properties

- 1. The desired optimal solution is composed of suitably chosen optimal solutions of the same problem with reduced data.**
- 2. The recursive formulation of the solution depends on many identical and repeated subproblems.
DP avoids unnecessary repeated computations by the method of tabulation (memoization) of the results of the subproblems.**

Dynamic programming

Application examples:

- **Optimal paths in graphs**
- **Longest subsequences with prescribed properties**
- **Knapsack problem**
- **Optimal scheduling of interdependent processes**
- **Approximate matching of patterns in text (bioinformatics)**
- **Longest common subsequence**
- **Optimal order of matrix multiplication**
- **Optimal binary search tree**
- **Optimal node/edge covering of a tree**
- **And many more....**

Dynamic programming

List of DP algorithms on en.wikipedia.org/wiki/Dynamic_programming

- Recurrent solutions to [lattice models](#) for protein-DNA binding
- [Backward induction](#) as a solution method for finite-horizon [discrete-time](#) dynamic optimization problems
- [Method of undetermined coefficients](#) can be used to solve the [Bellman equation](#) in infinite-horizon, [discrete-time](#), [discounted](#), [time-invariant](#) dynamic optimization problems
- Many [string](#) algorithms including [longest common subsequence](#), [longest increasing subsequence](#), [longest common substring](#), [Levenshtein distance](#) (edit distance)
- Many algorithmic problems on [graphs](#) can be solved efficiently for graphs of bounded [treewidth](#) or bounded [clique-width](#) by using dynamic programming on a [tree decomposition](#) of the graph.
- The [Cocke–Younger–Kasami \(CYK\) algorithm](#) which determines whether and how a given string can be generated by a given [context-free grammar](#)
- [Knuth's word wrapping algorithm](#) that minimizes raggedness when word wrapping text
- The use of [transposition tables](#) and [refutation tables](#) in [computer chess](#)
- The [Viterbi algorithm](#) (used for [hidden Markov models](#))
- The [Earley algorithm](#) (a type of [chart parser](#))
- The [Needleman–Wunsch](#) and other algorithms used in [bioinformatics](#), including [sequence alignment](#), [structural alignment](#), [RNA structure prediction](#)
- [Floyd's all-pairs shortest path algorithm](#)
- Optimizing the order for [chain matrix multiplication](#)
- [Pseudo-polynomial time](#) algorithms for the [subset sum](#) and [knapsack](#) and [partition](#) problems
- The [dynamic time warping](#) algorithm for computing the global distance between two time series
- The [Selinger](#) (a.k.a. [System R](#)) algorithm for relational database query optimization
- [De Boor algorithm](#) for evaluating B-spline curves
- [Duckworth–Lewis method](#) for resolving the problem when games of cricket are interrupted
- The value iteration method for solving [Markov decision processes](#)
- Some graphic image edge following selection methods such as the "magnet" selection tool in [Photoshop](#)
- Some methods for solving [interval scheduling](#) problems
- Some methods for solving [word wrap](#) problems
- Some methods for solving the [travelling salesman problem](#), either exactly (in [exponential time](#)) or approximately (e.g. via the [bitonic tour](#))
- [Recursive least squares](#) method
- [Beat tracking](#) in [music information retrieval](#)
- [Adaptive-critic training strategy](#) for [artificial neural networks](#)
- Stereo algorithms for solving the [correspondence problem](#) used in stereo vision
- [Seam carving](#) (content aware image resizing)
- The [Bellman–Ford algorithm](#) for finding the shortest distance in a graph
- Some approximate solution methods for the [linear search problem](#)
- [Kadane's algorithm](#) for the [maximum subarray problem](#)

Illustrative screen copy

Tabelation in DP - example

Function definition

$$f(x,y) = \begin{cases} 1 & (x = 0) \ || \ (y = 0) \\ 2 \cdot f(x, y-1) + f(x-1, y) & (x > 0) \ \&\& \ (y > 0) \end{cases}$$

Problem

$f(10,10) = ?$

Program

```
def f(x, y):
    if (x == 0) or (y == 0):
        return 1
    return 2*f(x,y-1) + f(x-1, y)
```

```
print( f(10,10) );
```

Solution

$f(10,10) = 127\ 574\ 017$ 😊

Tabelation in DP - example

Simple
analysis

```
count = 0

def f(x, y):
    global count
    count += 1
    if (x == 0) or (y == 0):
        return 1
    return 2*f(x,y-1) + f(x-1, y)
```

```
f(10,10)
print(count)
```

Analysis
result

count = 369 511



Tabelation in DP - example

More detailed analysis – recursion tree

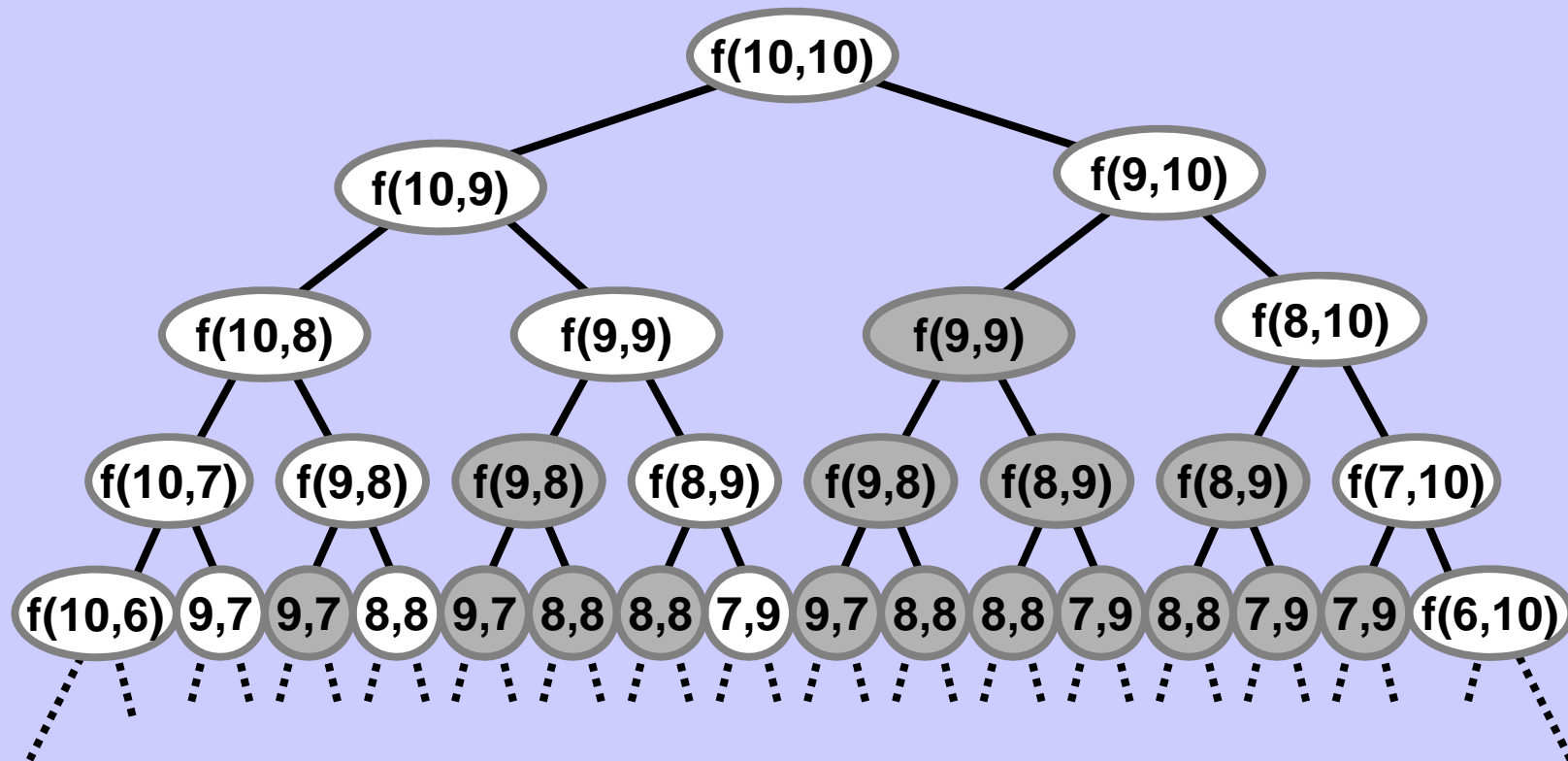

$f(x,y)$... repetitive calculations, many of them!

Tabelation in DP - example

Detailed analysis continues – recursive calls effectivity

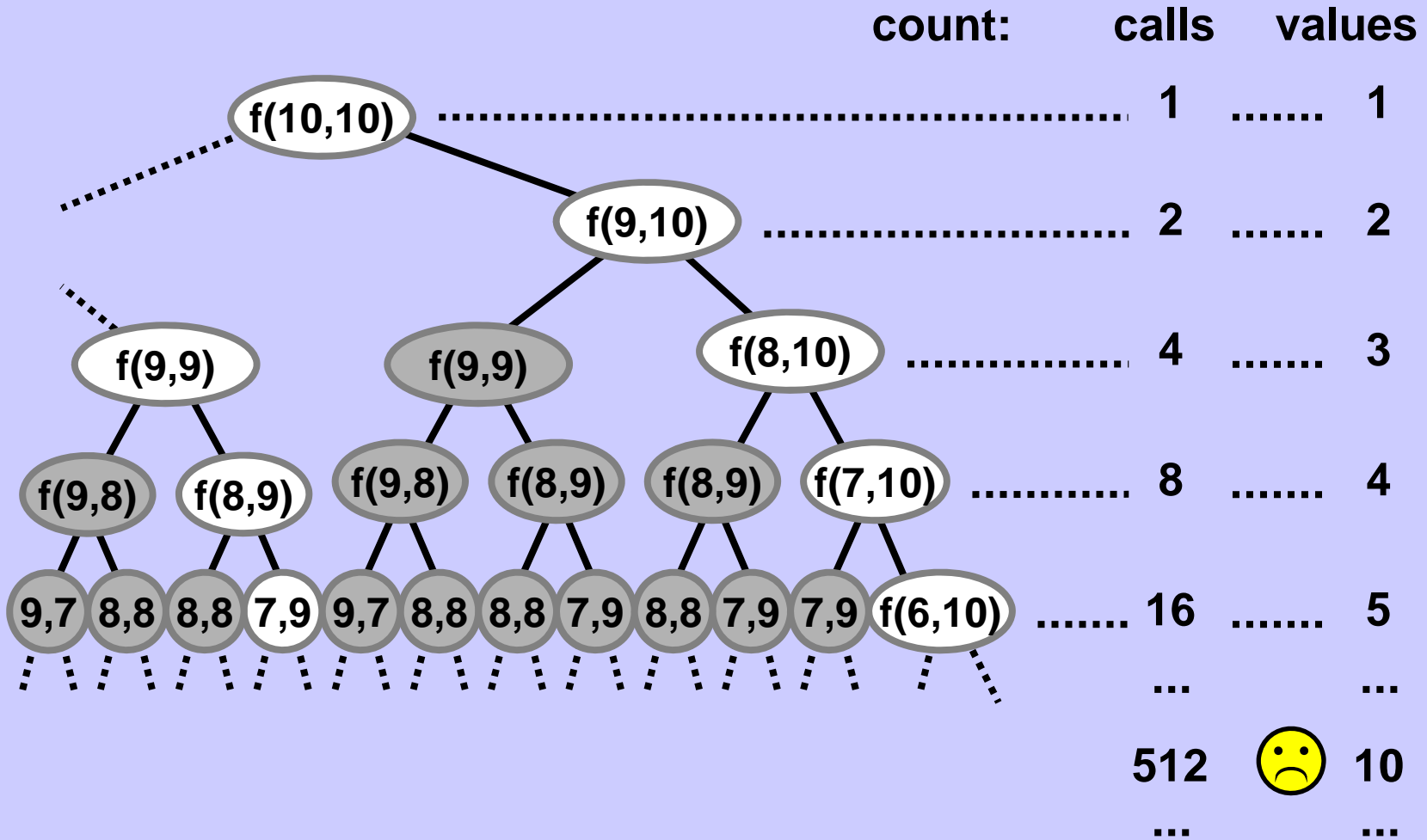

Tabelation in DP - example

$$f(x,y) = \begin{cases} 1 & (x = 0) \ || \ (y = 0) \\ 2 \cdot f(x, y-1) + f(x-1, y) & (x > 0) \ \&\& \ (y > 0) \end{cases}$$

Table in general

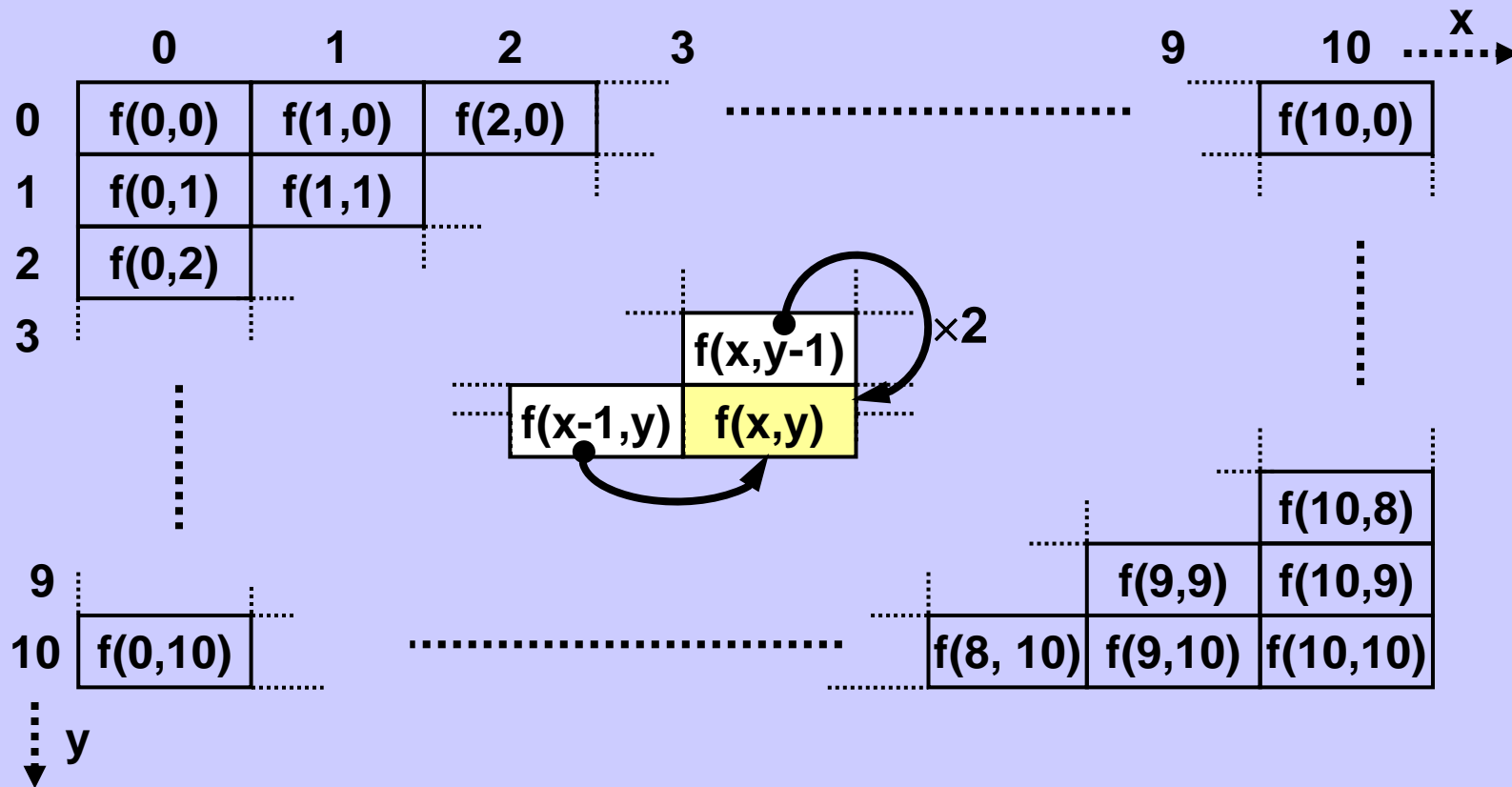

Tabelation in DP - example

$$f(x,y) = \begin{cases} 1 & (x = 0) \parallel (y = 0) \\ 2 \cdot f(x, y-1) + f(x-1, y) & (x > 0) \ \&\& \ (y > 0) \end{cases}$$

Table with numerical values

	0	1	2	3	4	...	9	10	$\dots \rightarrow x$
0	1	1	1	1	1		1	
1	1	3	5	7	9				
2	1	7	17	31					
3	1	15	49						
4	1	31							
	⋮								
9									
10	1					28000257	61616127	127574017
	⋮								
								8085505	
							16807935	32978945	

Diagram illustrating the recurrence relation for $f(x,y)$ with numerical values. The table shows values for x from 0 to 10 and y from 0 to 10. A callout shows the recurrence relation: $f(x,y) = 2 \cdot f(x, y-1) + f(x-1, y)$. The values in the table are: $f(0,0)=1, f(1,0)=1, f(2,0)=1, f(3,0)=1, f(4,0)=1, f(0,1)=1, f(1,1)=3, f(2,1)=5, f(3,1)=7, f(4,1)=9, f(0,2)=1, f(1,2)=7, f(2,2)=17, f(3,2)=31, f(0,3)=1, f(1,3)=15, f(2,3)=49, f(0,4)=1, f(1,4)=31, f(0,9)=1, f(1,9)=28000257, f(2,9)=61616127, f(3,9)=127574017, f(0,10)=1, f(1,10)=8085505, f(2,10)=16807935, f(3,10)=32978945.$

Tabelation in DP - example

All values are precomputed

```
def dynTable(M, N):  
  
    # initialize by constant x = 0 or y = 0  
    t = [[1]*(N+1) for i in range(M+1)]  
  
    for y in range(1, M+1):  
        for x in range(1, N+1):  
            t[y][x] = 2*t[y-1][x] + t[y][x-1]  
  
    return t[M][N]
```

Function call

```
def f(x, y):  
    return dynTable(y, x)
```

Optimal paths in graphs

Notation:

Graph $G = (V, E)$, set of nodes resp. edges: $V(G)$ resp. $E(G)$,
 $N = |V(G)|$, $M = |E(G)|$, or $n = |V|$, $m = |M|$ etc.

Path in a graph

= sequence of incident edges which contains each node
 at most once.

Path length in unweighted graph
 = no. of edges in the path.

Ex. Length (B D E F C) = 4.

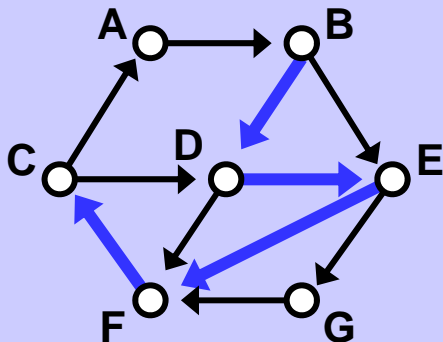

Path length in weighted graph
 = sum of edge weights
 in the path.

Ex. Length (A E F C G) = 14.

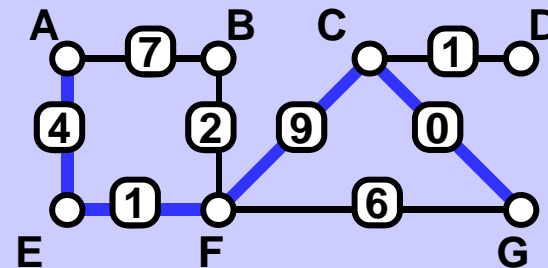

Optimal paths in graphs

Shortest paths

Problem of finding a shortest path between two given nodes or between more nodes or between all nodes in the graph. (E.g. Minimizing resources necessary to travel from x to y.)

Methods

The problem is solved for all practical cases of graphs. We met earlier BFS which solves simple cases, in more complex cases, particularly of weighted graphs, specific algorithms are available -- Dijkstra, Floyd-Warshall, Johnson, Bellman-Ford, etc.

Complexity

Asymptotic complexity is always polynomial in number of nodes and edges. Typically, the complexity of finding one path is at most $O(N^2)$, often less.

Optimal paths in graphs

Longest paths

Find a longest path between two given nodes or the longest path in the graph at whole.

(E.g. maximize the profit of temporary related processes.)

Exponential complexity

NP - hard problem

No systematic satisfactory solution has been found yet.

Possible strategies

1. Brute force -- exponential complexity, useless when $N > \text{cca } 20$.
2. Algorithms for approximate solutions with polynomial complexity
 - either find optimum with limited probability < 1
 - or can guarantee only a suboptimal solution
 - are often non-trivial and requiring advanced impementation.

Optimal paths in graphs

Possible strategies

3. Some specific types of graph allow for application of specific and effective algorithms (limited to that type of graph)

Most simple cases

3A.

Graph is a tree (both weighted or unweighted and both directed or undirected). Optimum path can be found in time $\Theta(N)$ by easy postorder traversal modification.

Opportunity for DP approach

3B.

Graph is directed and acyclic, may be weighted or unweighted. Standard abbreviation: DAG (Directed Acyclic Graph)

Topological order of DAG nodes

Topological order of DAG is such ordering of its nodes in which each edge points from the node with the lower order to the node with the higher order.

Each DAG can be topologically ordered, usually in more ways.

Any directed graph which contains at least one cycle cannot be topologically ordered.

Graphs in some DP problems are implicitly or naturally topologically ordered from the moment of problem posing.

Topological order of any DAG (at least one) can be found in time $\Theta(M)$, i.e. in time proportional to the number of edges.

DAG and its topological order

Example 1

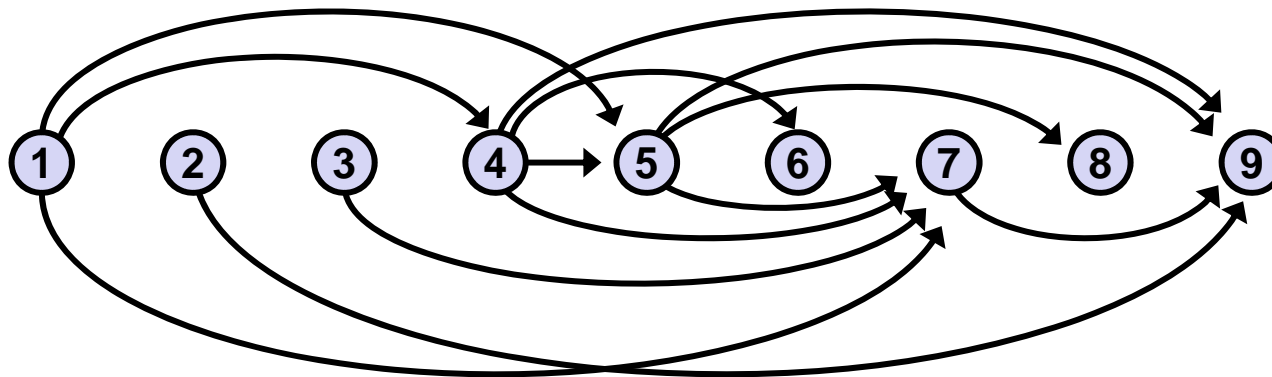
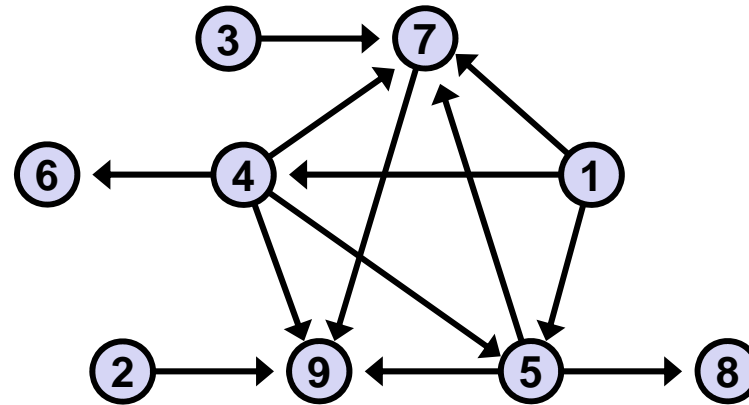

DAG and its various topological orders

Example 2a

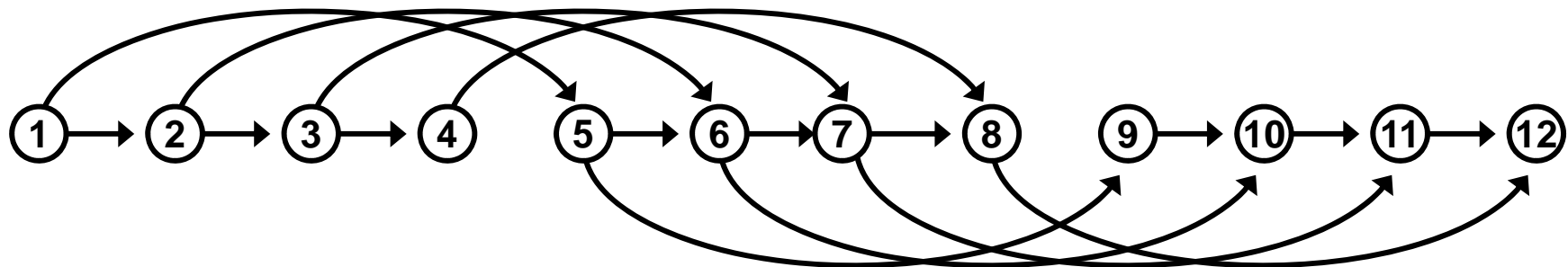
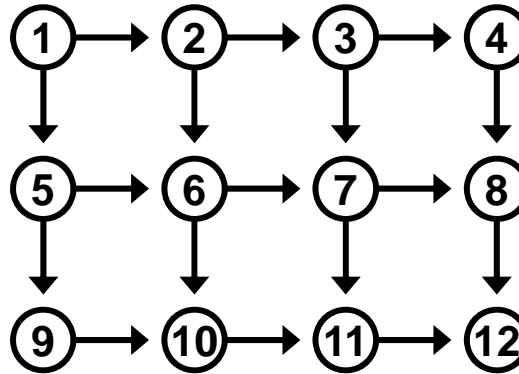

DAG and its various topological orders

Example 2b

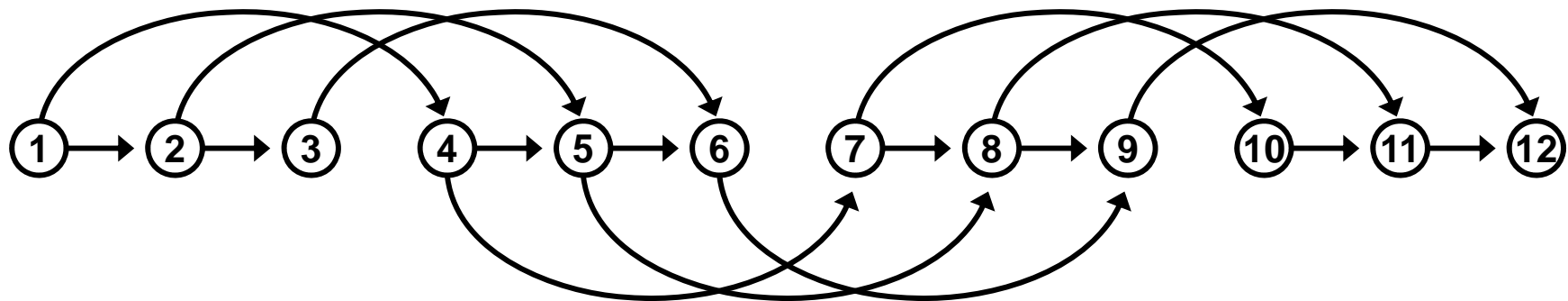
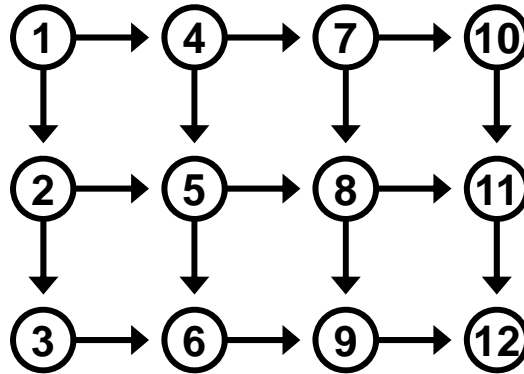

DAG and its various topological orders

Example 2c

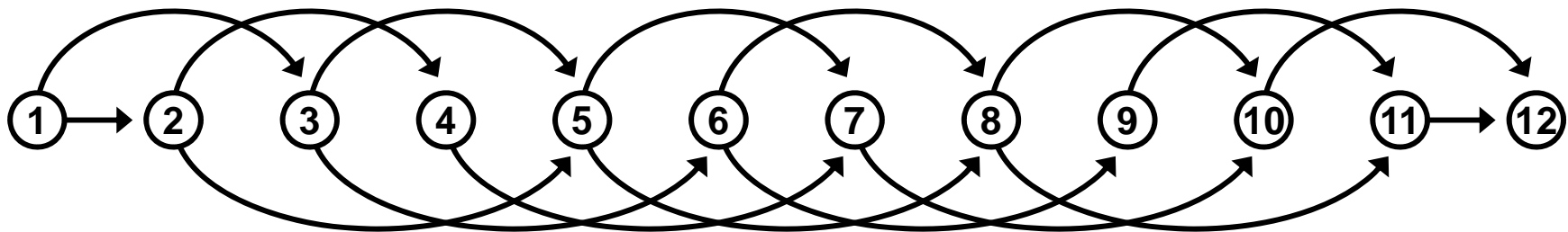
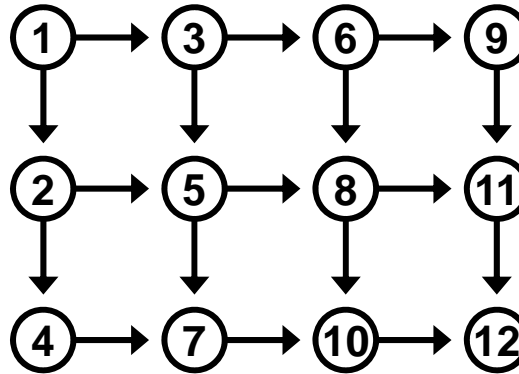

Topological sort

Algorithm

```

0. new queue Q of Node

1. for each x in V(G):
    if x.indegree == 0:      # x is a root
        Q.insert(x)

2. while !Q.empty():
    v = Q.pop()
    for each edge (v, w) ∈ E(G):
        G.removeEdge((v, w))
        if w.indegree == 0:  # w is a root
            Q.insert(w)
  
```

Complexity

We suppose that operation $G.removeEdge((v, w))$ has constant complexity.

```

0. Complexity  $O(N)$ 
1. Complexity  $\Theta(N)$ 
2. Complexity  $\Theta(M)$ ,
   each edge is visited exactly
   once and it is processed in
   constant time.
  
```

Complexity : $\Theta(N+M)$

The order in which nodes are inserted into the queue is the topological order of DAG.

Topological sort -- example

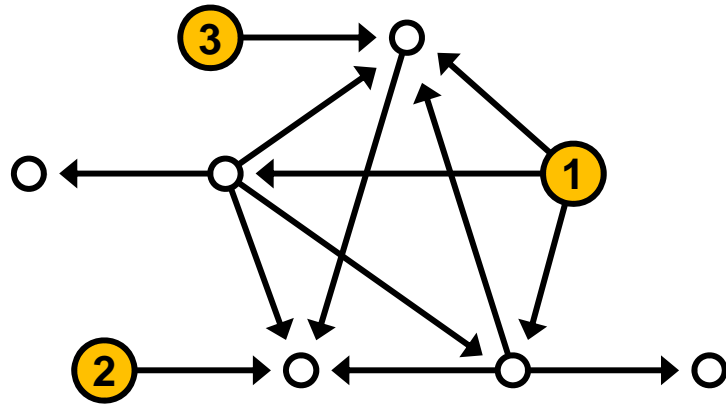

Queue: 1, 2, 3.

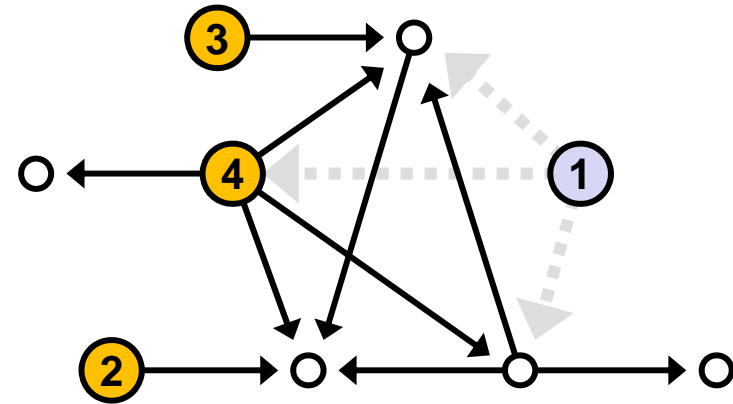

Queue: 2, 3, 4.

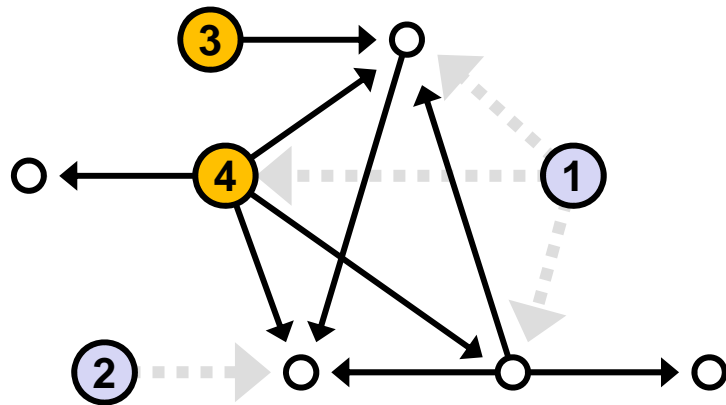

Queue: 3, 4.

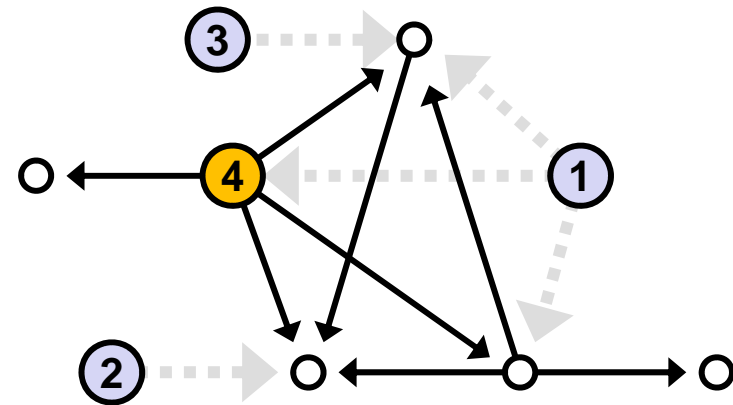

Queue: 4.

Topological sort -- example

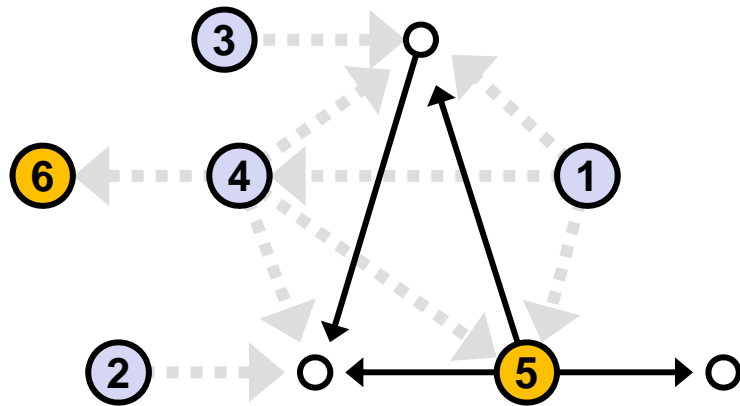

Queue: 5, 6.

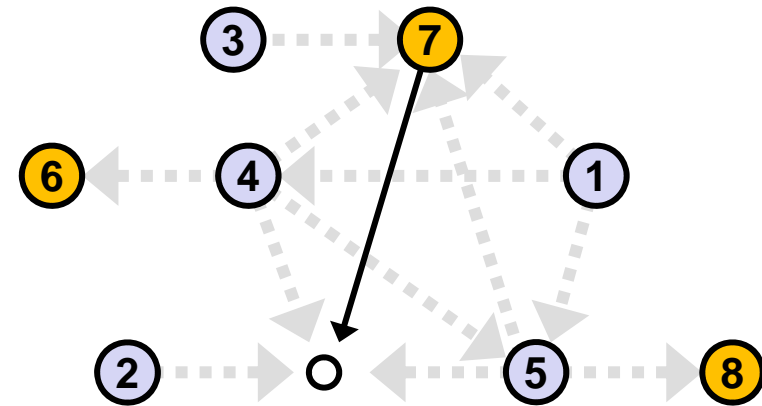

Queue: 6, 7, 8.

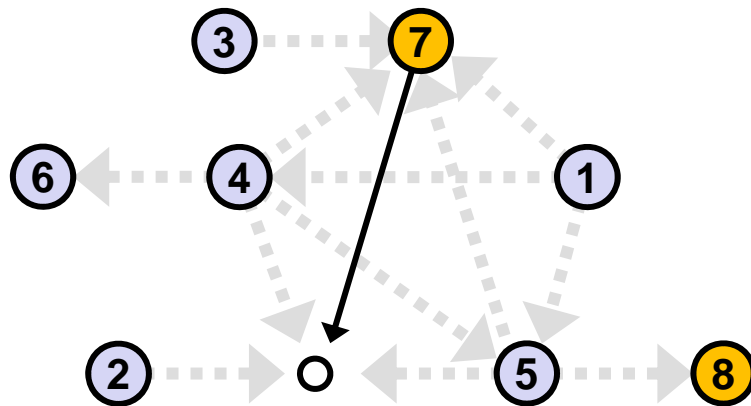

Queue: 7, 8.

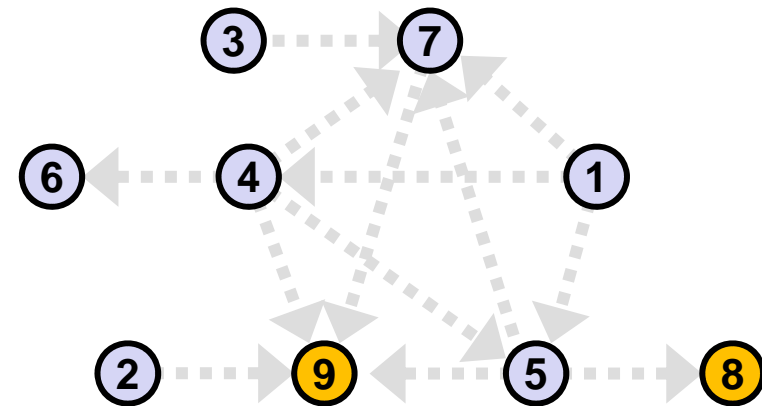

Queue: 8, 9.

Topological sort -- example

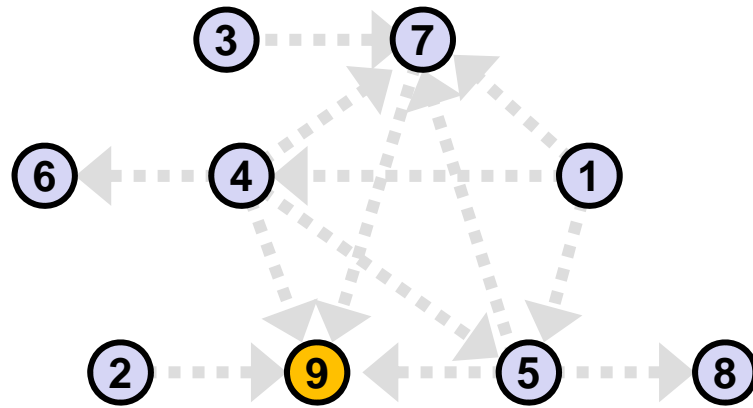

Queue: 9.

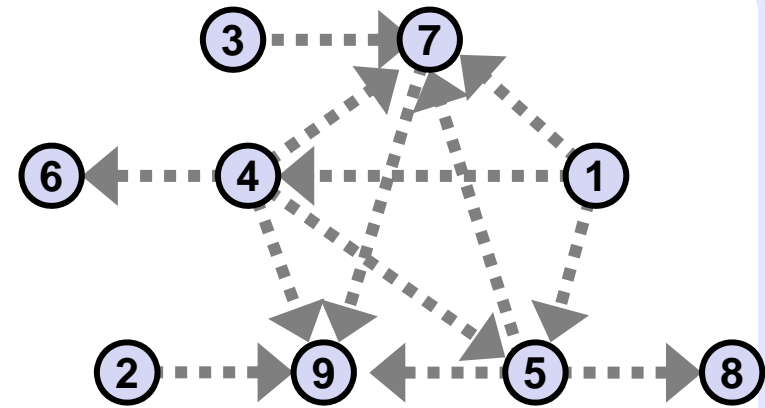

Queue: Empty.

Topological order

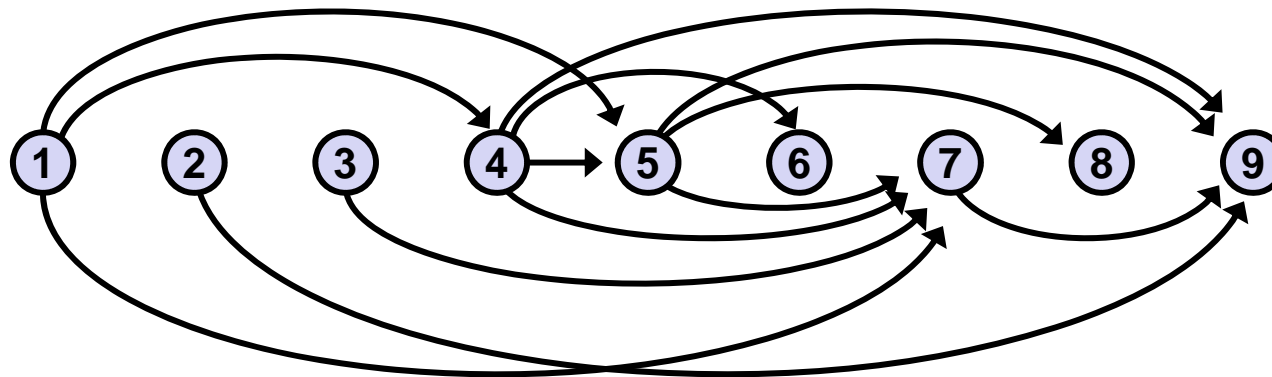

Longest path in DAG

We process nodes of DAG in their topological order.

Denote by $d[x]$ length of the path which ends in x and its length is maximal.

Charakteristic DP view "from the end to the beginning":

- $d[x]$ is set when values of d are known for all previous (= already processed) nodes in the topological order.
- $d[x]$ is the maximum of values $\{d[y_1] + w_1, d[y_2] + w_2, \dots, d[y_k] + w_k\}$, where $(y_1, x), (y_2, x), \dots$ are all edges ending in x and w_1, w_2, \dots are their respective weights.

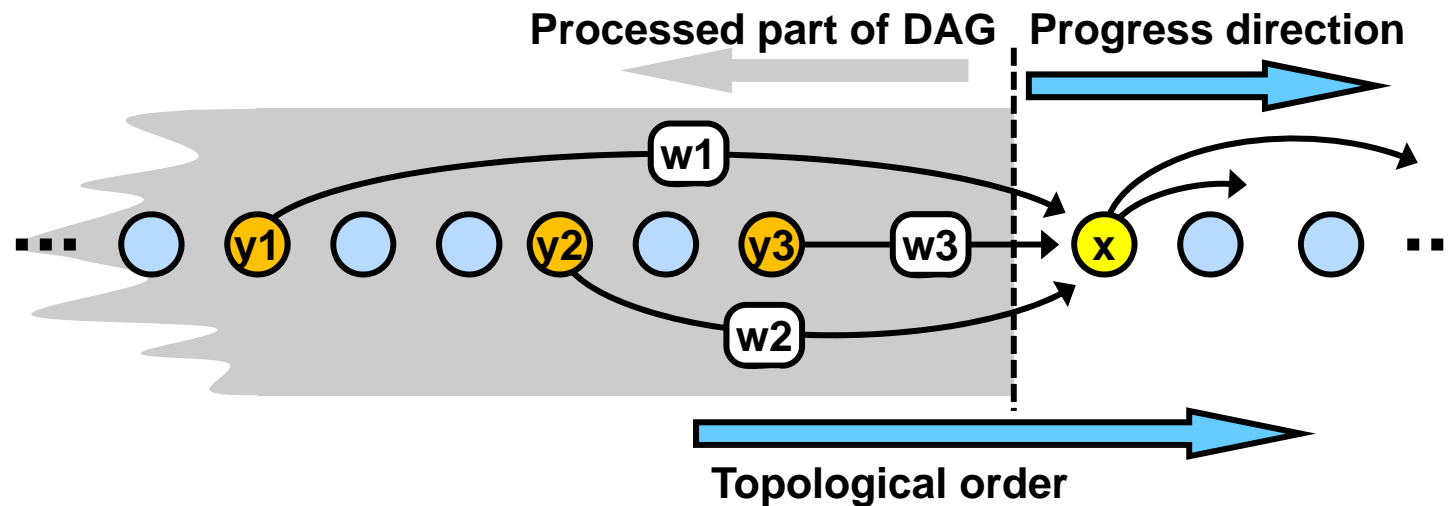

Longest path in DAG

- $d[x]$ is the maximum of values $\{d[y_1] + w_1, d[y_2] + w_2, \dots, d[y_k] + w_k\}$, where $(y_1, x), (y_2, x), \dots$ are all edges ending in x and w_1, w_2, \dots are their respective weights.
- If all values $\{d[y_1] + w_1, d[y_2] + w_2, \dots, d[y_k] + w_k\}$ are negative then none of them contributes to the longest path and the value of $d[x]$ is reset: $d[x] = 0$.
- The node y_j , for which the value $d[y_j] + w_j$ is maximal and non-negative, is set as a predecessor of x on the longest path.

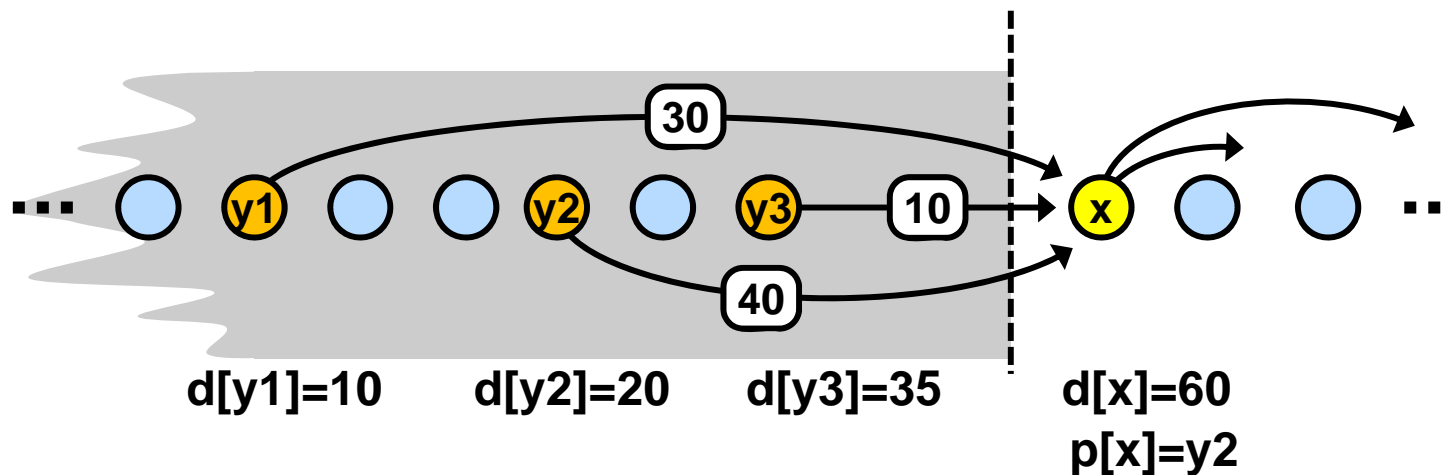

Longest path in DAG

Example

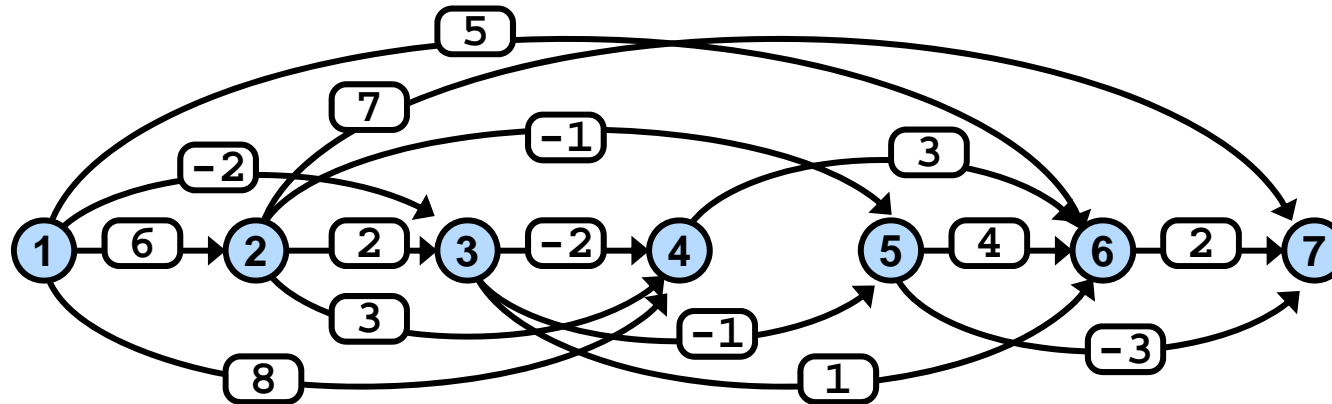

Find the longest path and its length.

Longest path in DAG

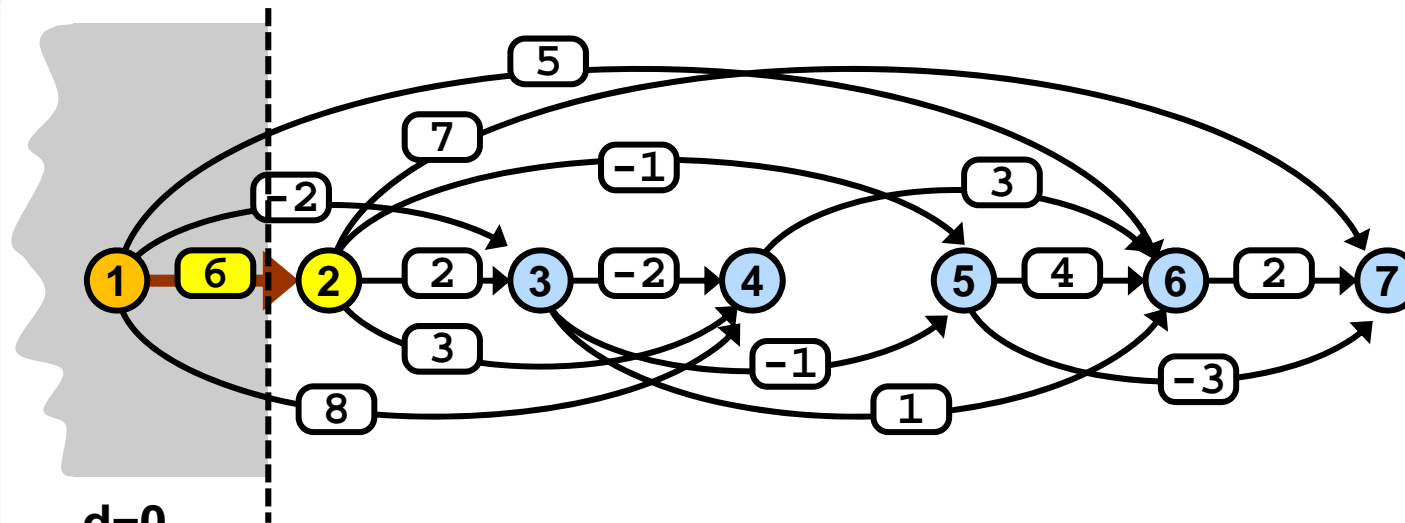

$d=0$

$p=nil$

$$d = \max \{0+6\}$$

$$= 6$$

$p=1$

Longest path in DAG

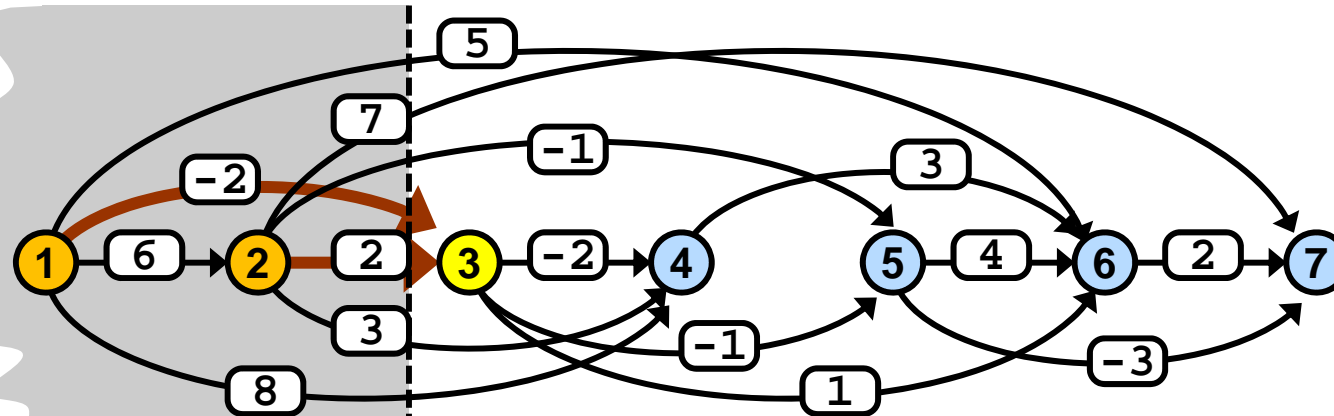

$d=0$

$d=6$

$p=\text{nil}$

$p=1$

$$d = \max \{0 + (-2), 6 + 2\}$$

$$= 8$$

$$p = 2$$

Longest path in DAG

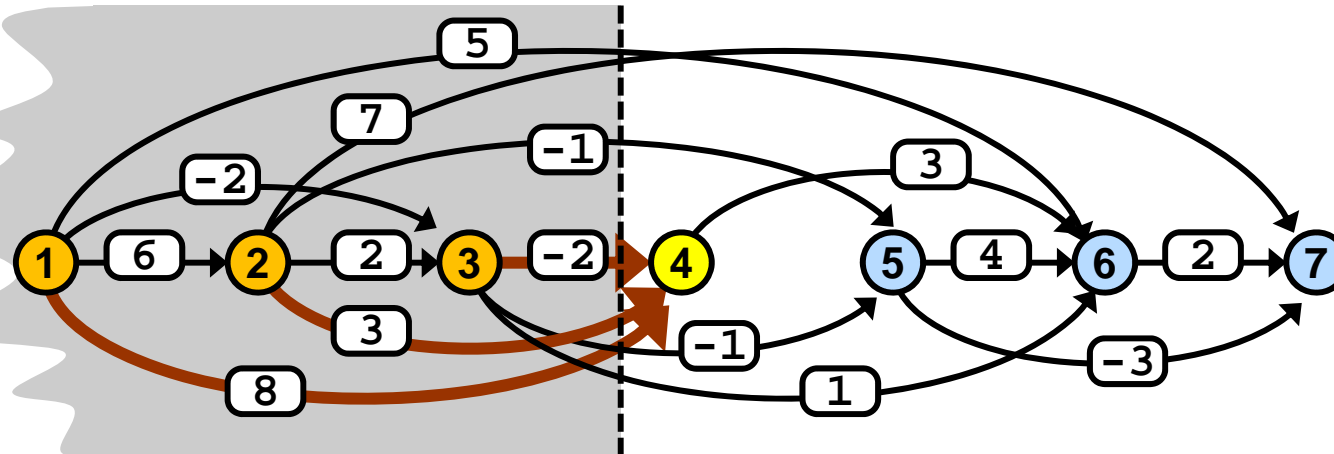

$d=0$
 $p=nil$

$d=6$
 $p=1$

$d=8$
 $p=2$

$d = \max \{0+8,$
 $6+3,$
 $8+-2\}$
 $= 9$

$p = 2$

Longest path in DAG

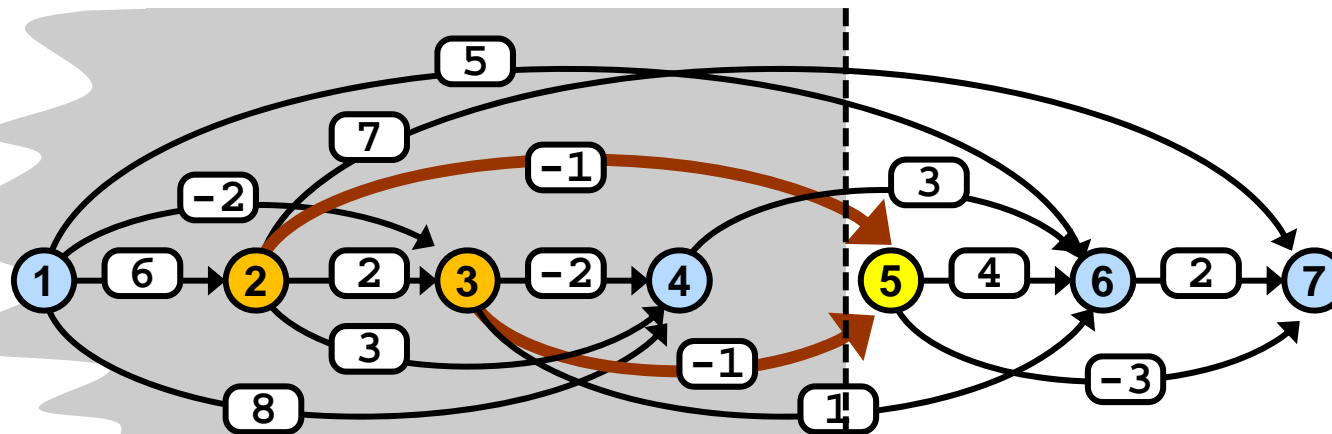

d=0
p=nil

d=6
p=1

d=8
p=2

d=9
p=2

$d = \max \{6+-1, 8+-1\}$

= 7

p = 3

Longest path in DAG

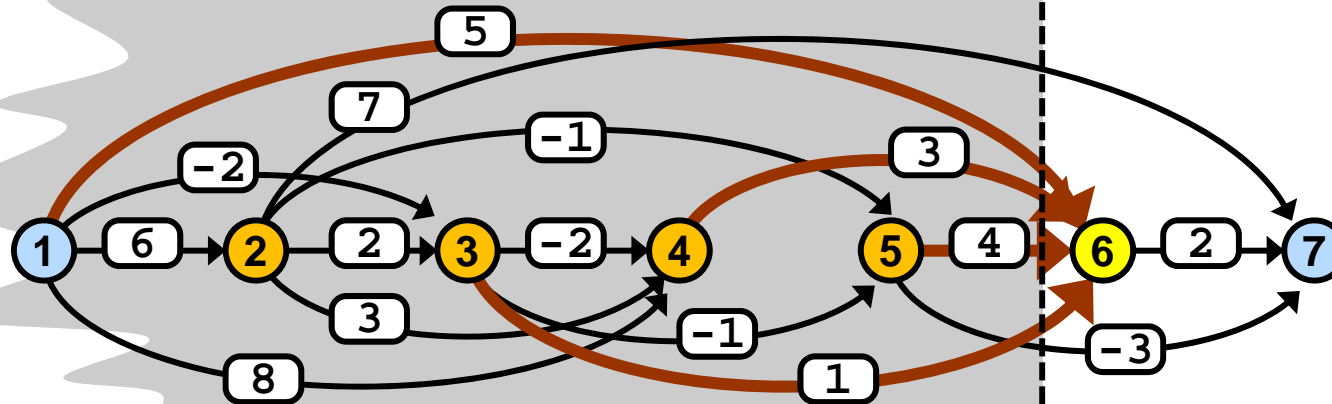

$d=0$	$d=6$	$d=8$	$d=9$	$d=7$	
$p=nil$	$p=1$	$p=2$	$p=2$	$p=3$	
					$d = \max \{0+5,$ $8+1,$ $9+3,$ $7+4\}$ $= 12$ $p = 4$

Longest path in DAG

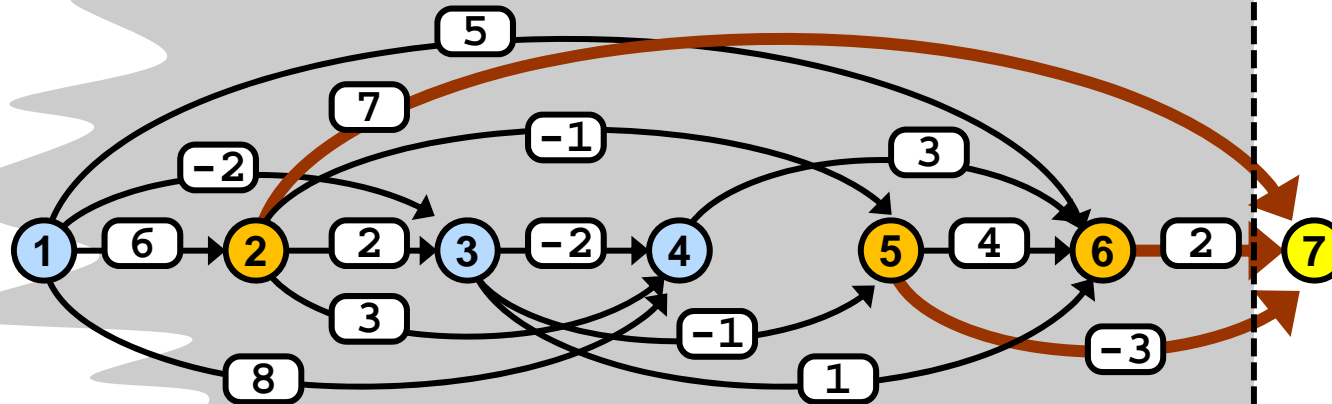

d=0
p=nil

d=6
p=1

d=8
p=2

d=9
p=2

d=7
p=3

d=12
p=4

$d = \max \{6+7, 7+-3, 12+2\}$
= 14

p = 6

Longest path in DAG

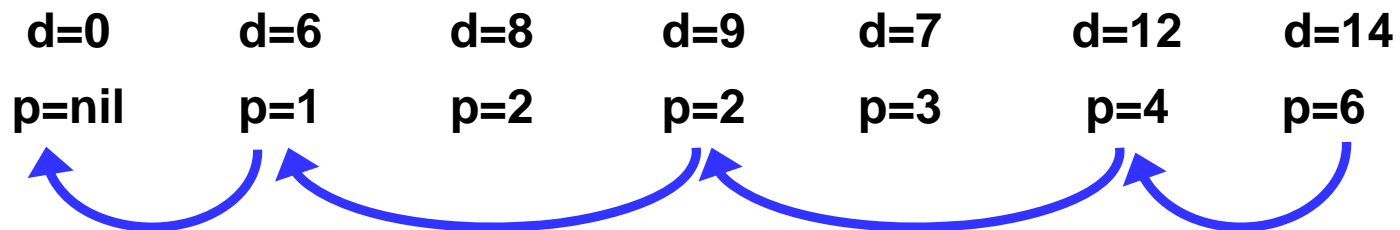
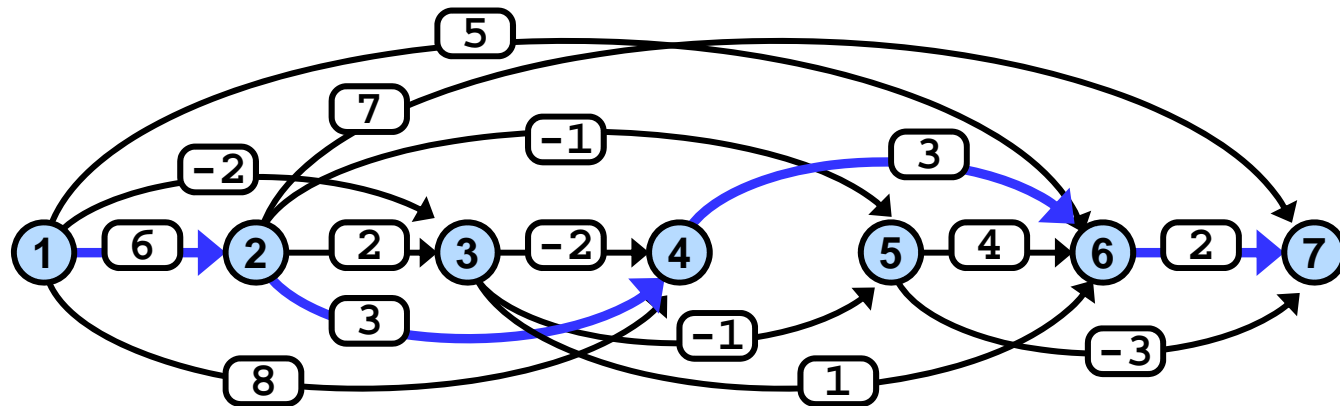

Length of the longest path: 14

The longest path itself: 1 -- 2 -- 4 -- 6 -- 7

Longest path in DAG

0. allocate memory for distance and predecessor of each node

1. for each x in $V(G)$:
 $x.\text{dist} = \text{negInfinity}$
 $x.\text{pred} = \text{null}$

supposing nodes are processed
 # in ascending topological order

2. for each node x in $V(G)$:
 for each edge $e = (y, x)$ in $E(G)$:
 if $x.\text{dist} < y.\text{dist} + e.\text{weight}$:
 $x.\text{dist} = y.\text{dist} + e.\text{weight}$
 $x.\text{pred} = y$
 }
 if $x.\text{dist} < 0$: $x.\text{dist} = 0$; # avoid negative path lengths
 }

0. Complexity $\Theta(N)$

1. Complexity $\Theta(N)$

2. Complexity $\Theta(M)$,
 each edge is visited exactly
 once and it is processed in
 constant time.

Complexity: $\Theta(N+M)$

Longest path in DAG

Variant I

2. for each node x in $V(G)$:

for each edge $e = (y, x)$ in $E(G)$:

if $x.\text{dist} < y.\text{dist} + e.\text{weight}$:

$x.\text{dist} = y.\text{dist} + e.\text{weight}$

$x.\text{pred} = y$

if $x.\text{dist} < 0$:

$x.\text{dist} = 0$

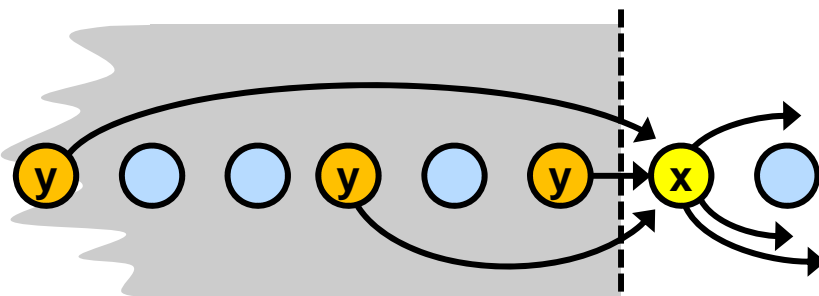

order of processing
= topological order

Variant II

2. for each node x in $V(G)$:

if $x.\text{dist} < 0$:

$x.\text{dist} = 0$

for each edge $e = (x, y)$ in $E(G)$:

if $y.\text{dist} < x.\text{dist} + e.\text{weight}$:

$y.\text{dist} = x.\text{dist} + e.\text{weight}$

$y.\text{pred} = x$

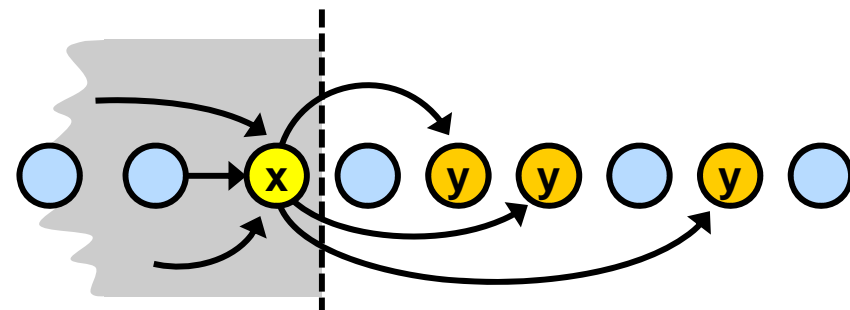

order of processing
= topological order

Longest path in DAG

Warning

Algorithms presented in the literature and on the web often solve the maximum path in DAG problem only for non-negative edge weights and do not mention explicitly this limitation. Those algorithms cannot handle DAG containing negative weight edges.

Incorrect result produced by algorithm expecting only non-negative edge weights

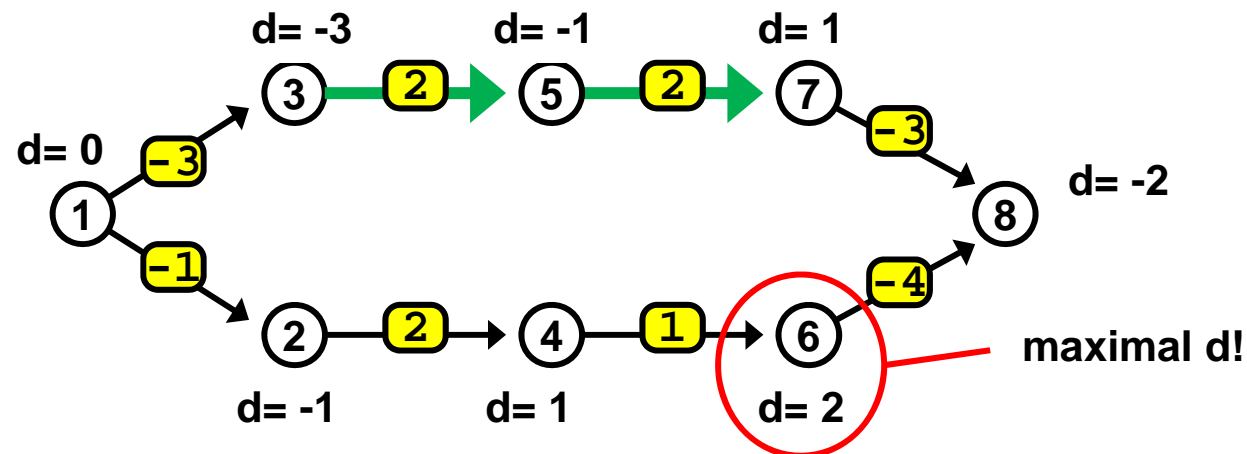

Actual maximum path is 3 -- 5 -- 7 which weight is 4.
 Algorithm limited to non-negative weights finds
 only suboptimal path 1 -- 2 -- 4 -- 6 which weight is 2.

Longest path in DAG

Problem of reconstructing all optimal paths
 -- the number of paths can be too big.

Example

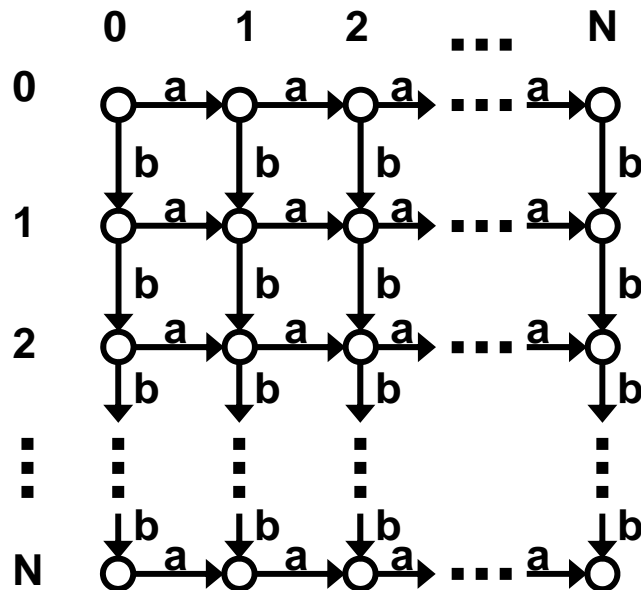

Each path from the root to the leaf is optimal, its weight is $N \cdot (a+b)$.

Number of all paths is $\text{Comb}(2N, N)$, and it holds $2^N < \text{Comb}(2N, N) < 4^N$.

The number of optimal paths thus grows exponentially with the value of N .

N	# of optimal paths
1	2
10	184756
20	137846528820
30	118264581564861424
40	107507208733336176461620