

Nukleární zobrazovací metody

PET, SPECT

J. Kybic

2008–2013

Zdroje

- <http://www.bic.mni.mcgill.ca/~louis/seminars/399-650/pet.html>
- http://ocw.mit.edu/NR/rdonlyres/Nuclear-Engineering/22-01Introduction-to-Ionizing-RadiationFall2003/60AA5867-88AE-49C7-9478-2F4661B4EBBE/0/pet_spect.pdf
- <http://www.pet.mc.duke.edu/rsna04/turk-petspectphysicsRSNA2005.pdf>
- <http://www.nuclear.kth.se/courses/medphys/5A1414/TOFPET1.pdf>
- <http://www.fmri.org>,
- A. Webb: Introduction to Biomedical Imaging

Principy nukleárního zobrazování

Radioaktivita

Gama kamera

SPECT

PET

Klinické aplikace PET

Závěr

Transmisní versus emisní zobrazování

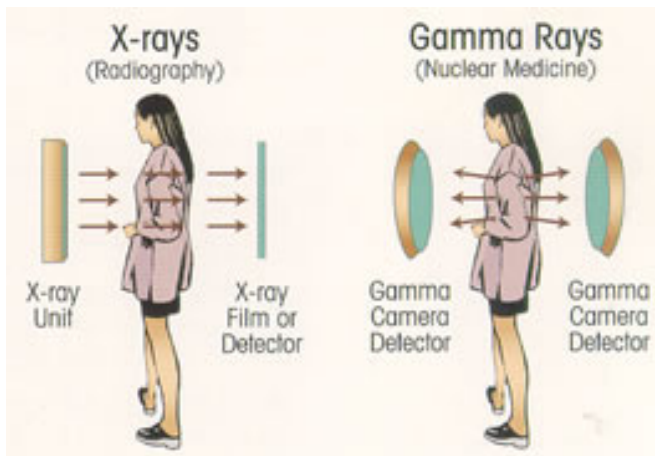

Nukleární versus rentgenové zobrazování

- **Rentgen a CT**

- *transmisní* zobrazování, zdroj vně těla

- **PET, SPECT**

- *emisní* zobrazování, zdroj uvnitř těla

Nukleární versus rentgenové zobrazování

- **Rentgen a CT**

- *transmisní* zobrazování, zdroj vně těla
- **Anatomické zobrazování**

- **PET, SPECT**

- *emisní* zobrazování, zdroj uvnitř těla
- **Funkční zobrazování (metabolismus), koncentrace radiofarmak**

Nukleární versus rentgenové zobrazování

- **Rentgen a CT**

- *transmisní* zobrazování, zdroj vně těla
- Anatomické zobrazování
- **Rentgenové záření**

- **PET, SPECT**

- *emisní* zobrazování, zdroj uvnitř těla
- Funkční zobrazování (metabolismus), koncentrace radiofarmak
- **γ záření**

Nukleární versus rentgenové zobrazování

- **Rentgen a CT**

- *transmisní* zobrazování, zdroj vně těla
- Anatomické zobrazování
- Rentgenové záření
- Rozlišení $< 1 \text{ mm}$

- **PET, SPECT**

- *emisní* zobrazování, zdroj uvnitř těla
- Funkční zobrazování (metabolismus), koncentrace radiofarmak
- γ záření
- Rozlišení $5 \sim 20 \text{ mm}$

Anatomické versus funkční zobrazování

- Kost
 - Rentgen/CT ukáže zlomeninu
 - PET/SPECT ukáže metabolismus při hojení
- Srdce
 - Rentgen/CT ukáže anatomii cév
 - PET/SPECT ukáže prokrvení srdečního svalu

Aplikace

- Kostí — metabolismus
- Srdce — prokrvení a metabolismus
- Mozek — prokrvení, funkce
- Ledviny — funkce, prokrvení
- Nádory — nádory, radioaktivně značené sondy

Anecdotes in nuclear imaging



- One of the pioneers of nuclear imaging was Hungarian physicist George de Hevesy
- He received the Nobel Prize for Chemistry in 1943 "for his work on the use of isotopes as tracers in the study of chemical processes"



Anecdotes in nuclear imaging



The first radiotracer investigation

One of de Hevesy's first experiments was the use of a radioactive tracer to prove that the hash served at his boarding house in Manchester contained meat he had left on his plate the evening before.

The first radiotracer investigation in clinical science

During a tea-break with fellow physicist Henry Mosely, Hevesy expressed a desire to "determine the fate of the individual water molecules contained in the cup of tea consumed."

A few years later Hevesy drank a cup of 'heavy water' and studied his urine for two weeks. This way he determined his body's water content at 43 liters.



Imaging modalities for nuclear imaging

- Planar γ -camera imaging (“scintigraphy”): The Anger Camera
- Single Photon Emission Computed Tomography (SPECT)
- Positron Emission Tomography (PET)

Principy nukleárního zobrazování

Radioaktivita

Gama kamera

SPECT

PET

Klinické aplikace PET

Závěr

Radioaktivita

- prvek = stejný počet protonů
- izotop = stejný počtem protonů i neutronů
- nedostatek/přebytek neutronů → nestabilita → radioaktivní rozpad → stabilní izotop

Principy nukleárního zobrazování

Radioaktivita

Radioaktivní rozpad

Produkce radionuklidů

Cyklotron

Radiofarmaka

Podávání a konstrukce radiofarmak

Přehled radioizotopů

Gama kamera

SPECT

PET

Klinické aplikace PET

Radioactive decay

- Nuclides with neutron excess: β^- decay (β^- = electron)



- Electron is ejected with high energy

Isomeric transition

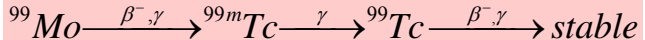

When Molybdenum decays, Technetium is formed which is in an excess state with a half-life of approx. 6 hours. It decays only leaving a gamma photon (not changing the nucleus!) which is called an isomeric transition

Popular Single Photon Emitters

Nuclide	Half-life	E_{photon} (keV)
^{67}Ga	3.25 days	84
		93
		185
		300
$^{99\text{m}}\text{Tc}$	6.0 hours	140
^{111}In	2.81 days	172
		247
^{131}I	8.1 days	364
^{201}Tl	3.0 days	70-80



Radioactive decay

- Nuclides with a neutron deficit, β^+ decay (β^+ = positron)

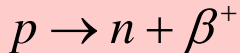

- Example: ^{11}C decays into boron-11
- Positron emitters are very short-lived. Positrons collide with an electron to annihilate and form two 511 keV photons

Positron Decay



<u>Nuclide</u>	<u>half-life</u>
C-11	20.3 min
N-13	10 min
O-15	124 sec
F-18	110 min
<i>Rb-82</i>	<i>75 sec</i>



Radioactive decay

- Radioactive decay is a stochastic process (governed by chance). Therefore decay is exponential
- Because of exponential decay, activity of radioactive sample never falls to zero
- Half-life values of radionuclides crucial for their application in medical imaging

Radionuclides

SI unit is the Becquerel (Bq)

$$1 \text{ Bq} = 1 \text{ dps (disintegration per second)}$$

old unit is the Curie (Ci)

$$1 \text{ Ci} = 3.7 \times 10^{10} \text{ dps}$$

Activity (A) = rate of decay

N_0 = number of active nuclei at time $t = 0$

$N(t)$ is the number of active nuclei at time 't'

λ is the *decay constant*

$$\lambda = 0.693/T \quad (T = \text{half-life})$$

$$dN/dt = -\lambda N(t)$$

$$N(t) = N_0 e^{-\lambda t}$$

$$A(t) = A_0 e^{-\lambda t}$$

Effective Half-Life

Physical half-life, T_P [radioactive decay]

Biological half-life, T_B [clearance from the body]

$$A = A_0 e^{-\lambda_{phys} t} e^{-\lambda_{biol} t}$$

$$A = A_0 e^{-(\lambda_P + \lambda_D)t} \quad \lambda_P + \lambda_B = \lambda_E$$

$$\frac{1}{T_E} = \frac{1}{T_B} + \frac{1}{T_P} \quad \text{or} \quad T_E = \frac{T_P T_B}{T_P + T_B}$$

Effective Half-Life

E.g., for an isotope with a 6-hr half life attached to various carrier molecules with different biological half-lives.

T_P	T_B	T_E
6 hr	1 hr	0.86 hr
6 hr	6 hr	3 hr
6 hr	60 hr	5.5 hr
6 hr	600 hr	5.9 hr

Effective Half-Life

Assume 10^6 Bq localized in a tumor site, vary T

Nuclide	Half-life (T)	λ (sec⁻¹)	N
1	6 sec	0.115	8.7×10^7
2	6 min	1.75×10^{-3}	5.7×10^9
3	6 hrs	3.2×10^{-5}	3.1×10^{11}
4	6 days	1.3×10^{-6}	7.7×10^{12}
5	6 years	4×10^{-9}	2.5×10^{15}

Effective Half-Life

Assume 10^{10} atoms of radionuclide localized in a tumor site, vary T

Nuclide	Half-life (T)	λ (sec^{-1})	Activity (Bq)
1	6 sec	0.115	1.15×10^9
2	6 min	1.75×10^{-3}	1.7×10^7
3	6 hrs	3.2×10^{-5}	3.2×10^6
4	6 days	1.3×10^{-6}	1.3×10^4
5	6 years	4×10^{-9}	40

Principy nukleárního zobrazování

Radioaktivita

Radioaktivní rozpad

Produkce radionuklidů

Cyklotron

Radiofarmaka

Podávání a konstrukce radiofarmak

Přehled radioizotopů

Gama kamera

SPECT

PET

Klinické aplikace PET

Production of radionuclides

- Only few radionuclides exist in nature, they require long half-life times (uranium, radium, radon)
- In nuclear medical imaging, unstable radionuclides are produced
- E.g. force an additional neutron into a stable nucleus in a nuclear reactor – **neutron excess**

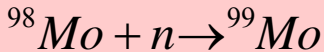

Mo=Molybdenum

Production of Radionuclides

Reactor production, Nuclear fission

- Heavy nuclides ($A > 230$) capture a neutron; tend to fission
- Daughter nuclides of \sim half the parent mass are produced
- Possible to purify nuclides carrier free (chemically different)
- Nuclides generally neutron rich and decay by β^- emission

Production of radionuclides

- E.g. force an additional proton into a stable nucleus, knocking out a neutron – **neutron deficit**

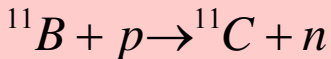

B=Boron
C=Carbon

- This process occurs in a cyclotron. Since atomic number changes, unstable nuclei can be separated chemically from the original stable nuclei. They are short-lived. A cyclotron should be close to the hospital!

Production of Radionuclides

Cyclotron production: Charged particle bombardment

- **Accelerates charged particles to high energies**
- **Nuclear reactions have threshold energies**
- **The product is different than the target**
- **Nuclides can be produced carrier-free**

Principy nukleárního zobrazování

Radioaktivita

Radioaktivní rozpad

Produkce radionuklidů

Cyklotron

Radiofarmaka

Podávání a konstrukce radiofarmak

Přehled radioizotopů

Gama kamera

SPECT

PET

Klinické aplikace PET

Výroba radionuklidů

Radioisotope delivery system (RDS)

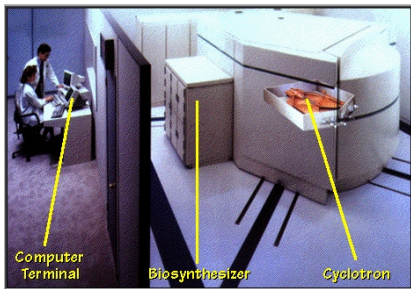

- Cyklotron (urychlovač částic)
- Biosyntetizér — výroba biologicky relevantních molekul
- Řídící počítač

Cyklotron

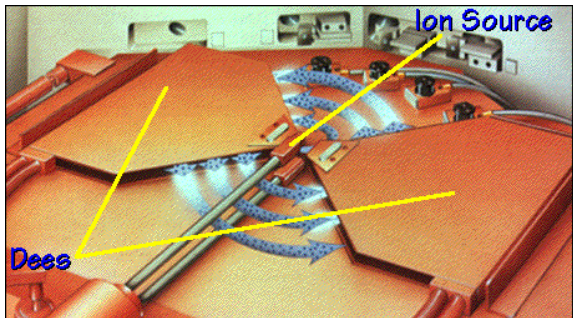

- Vakuum
- Zdroj záporně nabitých iontů (dávkový)
- Duté polokruhové elektrody ve tvaru D; střídavé pole
- Magnetické pole (orientované svisle)

Cyklotron

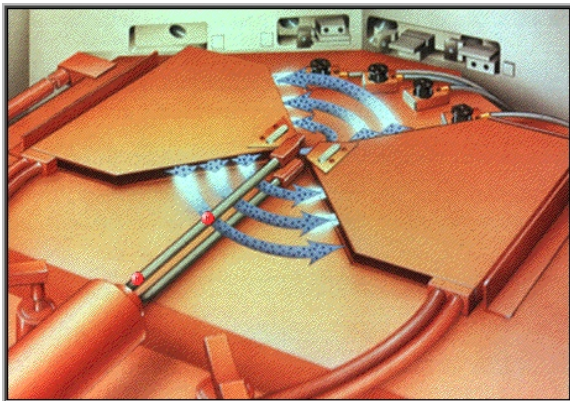

- Vakuum
- Zdroj záporně nabitých iontů (dávkový)
- Duté polokruhové elektrody ve tvaru D; střídavé pole
- Magnetické pole (orientované svisle)

Cyklotron

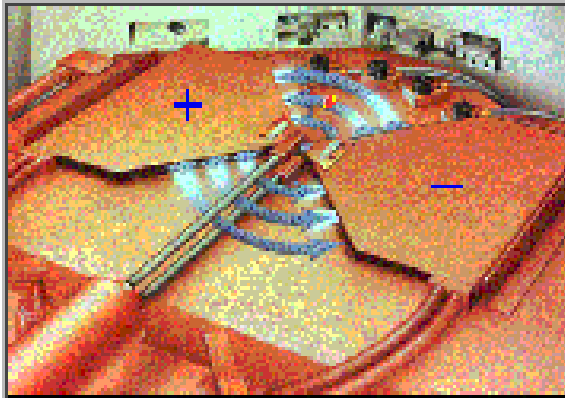

- Vakuum
- Zdroj záporně nabitých iontů (dávkový)
- Duté polokruhové elektrody ve tvaru D; střídavé pole
- Magnetické pole (orientované svisle)

Carousel

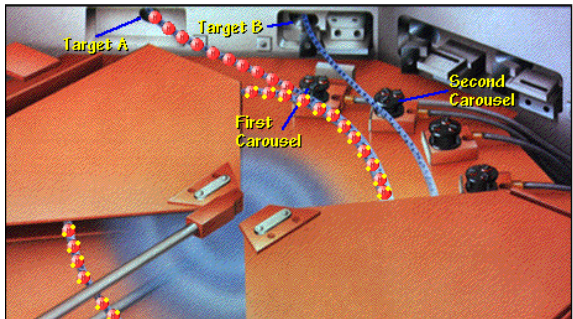

- H^- iont narazí na tenkou uhlíkovou fólii
- \rightarrow ztrácí elektrony, stane se H^+
- \rightarrow začne kroužit po kruhové dráze s opačnou orientací
- Jen část paprsku je odkloněna
- Životnost fólie asi 100 hodin

Carousel

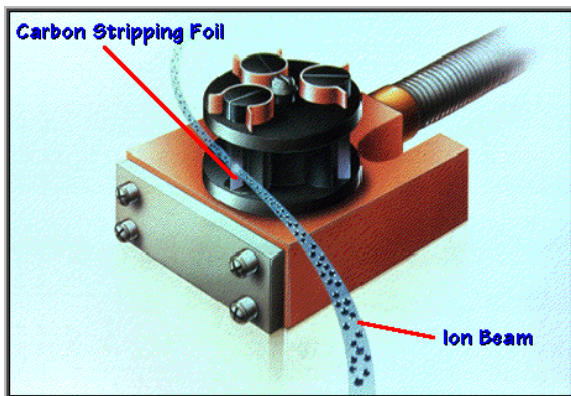

- H^- iont narazí na tenkou uhlíkovou fólii
- \rightarrow ztrácí elektrony, stane se H^+
- \rightarrow začne kroužit po kruhové dráze s opačnou orientací
- Jen část paprsku je odkloněna
- Životnost fólie asi 100 hodin

Carousel

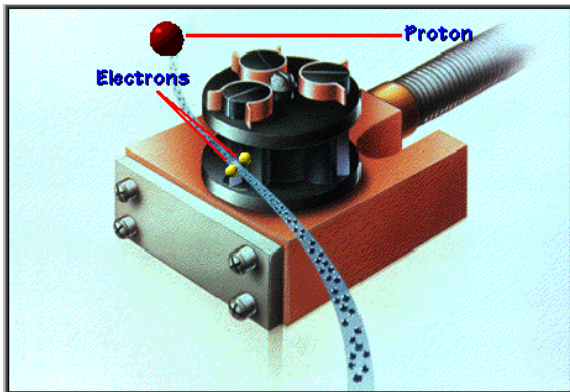

- H^- iont narazí na tenkou uhlíkovou fólii
- \rightarrow ztrácí elektrony, stane se H^+
- \rightarrow začne kroužit po kruhové dráze s opačnou orientací
- Jen část paprsku je odkloněna
- Životnost fólie asi 100 hodin

Target chamber

Reakční komora

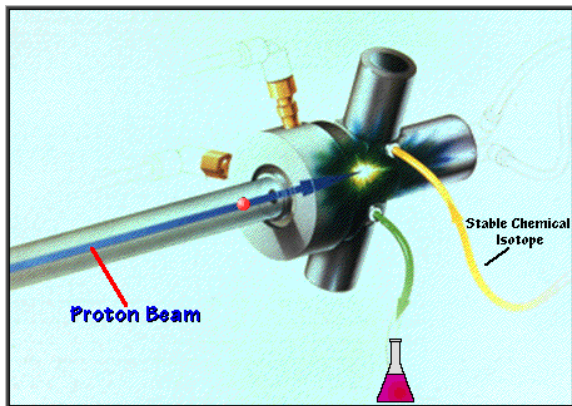

- Reakční komora je naplněna stabilním izotopem
- Bombardováním ionty vzniká radioaktivní izotop
- Komora je součástí RDS systému kvůli stínění. Malé rozměry, snadno vyměnitelná.

Biosyntetizér

Biosynthesizer

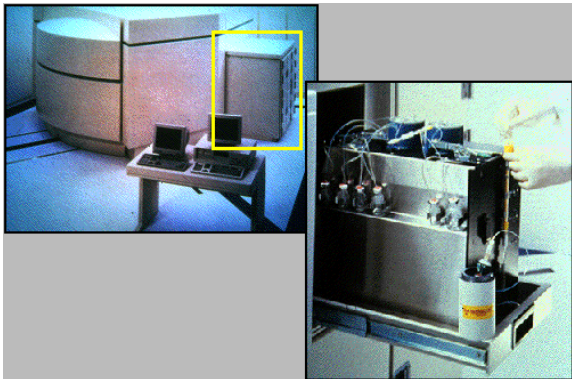

- Chemické reakce pro výrobu radioaktivně značkových biologicky aktivních/kompatibilních sloučenin.

Principy nukleárního zobrazování

Radioaktivita

Radioaktivní rozpad

Produkce radionuklidů

Cyklotron

Radiofarmaka

Podávání a konstrukce radiofarmak

Přehled radioizotopů

Gama kamera

SPECT

PET

Klinické aplikace PET

Radiation dose

- Comparable to studies in diagnostic radiology
- As Low As Reasonably Achievable (ALARA)
- Select short half-life if possible.

For diagnostics: pure γ -emitters if possible

- Note: α and β radiators (high absorption in tissue) can be useful for radionuclide therapy (e.g. for destroying tumors, a.k.a. “internal radiotherapy”)
- Radionuclide imaging works with open sources (Tc-99m, Tl-201, I-123, I-131), produced by cyclotron, fission or “generator”. This is in contrast with Radiotherapy and Radiology.

Properties of the ideal diagnostic radiopharmaceutical

1. Pure gamma emitter
2. $100 < \text{gamma energy} < 250 \text{ keV}$.
3. Effective half-life = 1.5 X test duration.
4. High target:nontarget ratio.
5. Minimal radiation dose to patient and Nuclear
Medicine personnel
6. Patient Safety
7. Chemical Reactivity
8. Inexpensive, readily available radiopharmaceutical.
9. Simple preparation and quality control if
manufactured in house.

Properties of the ideal diagnostic radiopharmaceutical

One nuclide comes close to being the ideal gamma-emitting nuclide

Technetium-99m (^{99m}Tc)

- **Half-life = 6 hr**
- **Almost a pure γ ray emitter**
- **E = 140 keV**
- **can be obtained at high specific activity and carrier free**

Isomeric transition

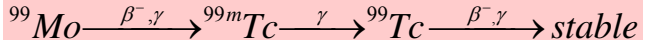

When Molybdenum decays, Technetium is formed which is in an excess state with a half-life of approx. 6 hours. It decays only leaving a gamma photon (not changing the nucleus!) which is called an isomeric transition

Table of the nuclides

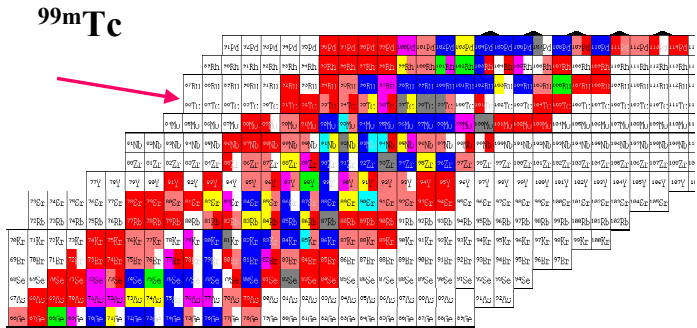

Original source: Brookhaven National Laboratories.
 (site no longer maintained - see <http://www2.bnl.gov/CoN/>)

Decay scheme for ^{99m}Tc

^{99}Mo decays to ^{99m}Tc by β - emission (^{99}Mo : $T=67$ hrs)

^{99m}Tc excited nuclear state decays by γ emission (140 keV) to ground state

^{99}Tc (^{99m}Tc : $T=6$ hrs)

^{99}Tc (ground state) decays by β - emission to ^{99}Ru (stable isotope)

(^{99}Tc : $T=2 \times 10^5$ years)

Image removed.

Radioactive equilibrium

Parent N_1 decays to daughter N_2 , both are radioactive.

Special Case: Transient equilibrium



$T_1 > T_2$, but not greatly so. [$A = \lambda N$, $A = A_0 e^{-\lambda t}$]

$$\frac{dN_2}{dt} = \lambda_1 N_1 - \lambda_2 N_2 \quad \Rightarrow \Rightarrow A_2 = A_{10} \frac{\lambda_1}{\lambda_2 - \lambda_1} (e^{-\lambda_1 t} - e^{-\lambda_2 t}) + A_{20} e^{-\lambda_2 t}$$

Simplifying assumptions: $A_{20} = 0$; After ~ 10 half-lives, $e^{-\lambda_2 t} \ll e^{-\lambda_1 t}$

$$A_2 = A_{10} \frac{\lambda_1}{\lambda_2 - \lambda_1} e^{-\lambda_1 t} \qquad A_1 = A_{10} e^{-\lambda_1 t}$$

$$A_2 = A_1 \frac{\lambda_1}{\lambda_2 - \lambda_1} \qquad \text{or} \qquad \frac{A_2}{A_1} = \frac{\lambda_1}{\lambda_2 - \lambda_1}$$

The ^{99m}Tc Generator

^{99}Mo is adsorbed on an alumina column as ammonium molybdate (NH_4MoO_4)

^{99}Mo (T = 67 hrs) decays (by β^- -decay) to ^{99m}Tc (T = 6 hrs)

$^{99}\text{MoO}_4$ ion becomes the $^{99m}\text{TcO}_4$ (pertechnetate) ion (chemically different)

$^{99m}\text{TcO}_4$ has a much lower binding affinity for the alumina and can be *selectively eluted* by passing physiological saline through the column.

Image removed.

Chelators

Image removed.
^{99m}Tc MERTIATIDE bond structure

Image removed.
Technetium Pentetate bond structure

EDTA
ethylenediaminetetraacetate

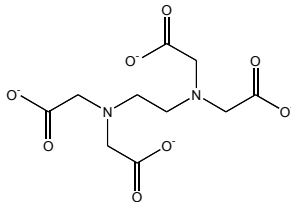

DTPA

Chart of the Nuclides

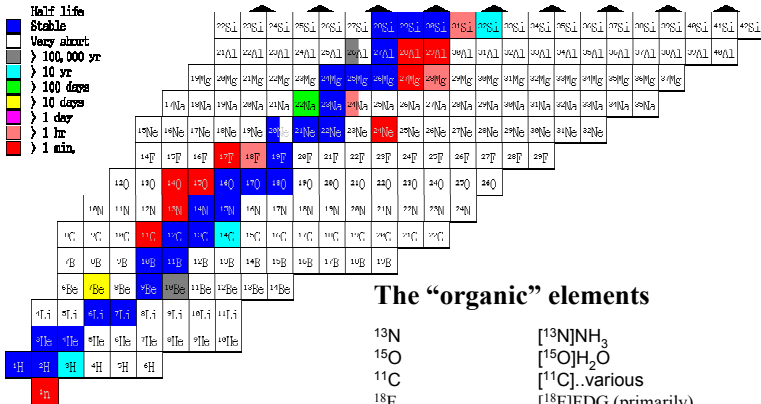

Original source: Brookhaven National Laboratories.
 (site no longer maintained - see <http://www2.bnl.gov/CoN/>)

Cyclotron Production

Targets

O-15: $^{14}\text{N}(\text{d},\text{n})^{15}\text{O}$; deuterons on natural N_2 gas; $^{15}\text{O}_2$ directly or C^{15}O_2 , by mixing 5% carrier CO_2 gas.

C-11: $^{14}\text{N}(\text{p},\alpha)^{11}\text{C}$; protons on natural N_2 gas: including 2% O_2 produces $^{11}\text{CO}_2$

N-13: $^{16}\text{O}(\text{p},\alpha)^{13}\text{N}$; protons on distilled water

F-18: $^{18}\text{O}(\text{p},\text{n})^{18}\text{F}$; protons on ^{18}O -enriched water (H_2^{18}O),. Fluoride is recovered as an aqueous solution. For nucleophilic substitution.

F-18: $^{20}\text{Ne}(\text{d},\alpha)^{18}\text{F}$; deuterons on neon gas. For electrophilic substitutions.

Principy nukleárního zobrazování

Radioaktivita

Radioaktivní rozpad

Produkce radionuklidů

Cyklotron

Radiofarmaka

Podávání a konstrukce radiofarmak

Přehled radioizotopů

Gama kamera

SPECT

PET

Klinické aplikace PET

Podávání radiofarmak

- Většinou filtrovaný slaný (fyziologický) roztok

Podávání radiofarmak

- Většinou filtrovaný slaný (fyziologický) roztok
- Bariéra mezi mozkem a krví (blood-brain barrier) (*Paul Ehrlich, 18.stol.*)
 - Kontrastní látka podaná intravenózně se nedostane do mozku
 - Kontrastní látka vstříknutá do mozkomíšního moku se dostane jen do mozku a míchy, nikoliv do ostatních tkání.

Podávání radiofarmak

- Většinou filtrovaný slaný (fyziologický) roztok
- Bariéra mezi mozkem a krví (blood-brain barrier) (*Paul Ehrlich, 18.stol.*)
 - Kontrastní látka podaná intravenózně se nedostane do mozku
 - Kontrastní látka vstříknutá do mozkomíšního moku se dostane jen do mozku a míchy, nikoliv do ostatních tkání.
- Další metabolické bariery
- Afinity a různá rychlost metabolismu

Delivery Strategies: Metabolic pathways

FDG

2-fluoro-2-deoxy-glucose

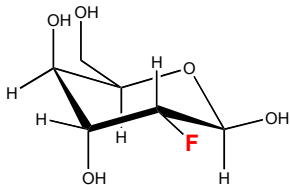

B-D-glucose

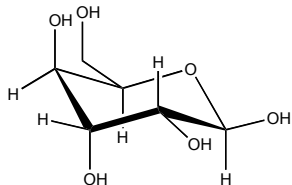

Použití FDG

- Pro mapování mozkových funkcí
- ... *glukóza* do mozku projde (dodává energii, u dospělého ~ 100 g/den)

Použití FDG

- Pro mapování mozkových funkcí
- ... *glukóza* do mozku projde (dodává energii, u dospělého ~ 100 g/den)
- Pro mapování nádorů
- ... nádory nemají metabolickou bariéru

FDG in Oncology

- FDG transport into tumors occurs at a *higher* rate than in the surrounding normal tissues.
- FDG is de-phosphorylated and can then leave the cell.
- The dephosphorylation occurs at a *slower* rate in tumors.

Applications of FDG

- Locating unknown primaries
- Differentiation of tumor from normal tissue
- Pre-operative staging of disease (lung, breast, colorectal, melanoma, H&N, pancreas)
- Recurrence vs necrosis
- Recurrence vs post-operative changes (limitations with FDG)
- Monitoring response to therapy

Konstrukce radiofarmaka

Radionuklid + nosná (carrier) molekula

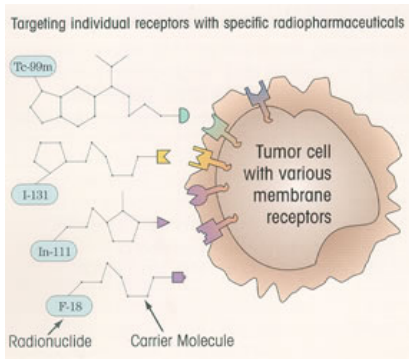

Delivery Strategies: Metabolic pathways

PET can provide highly specific metabolic information.

- FDG, MET, FLT are incorporated via transporters
- Uptake is indicative of tumor grade.

¹¹C-methionine

- specific for tumor
- avoids high brain background problem seen with FDG
- no significant uptake in chronic inflammatory or radiogenic lesions
- MET better than FDG in low-grade gliomas

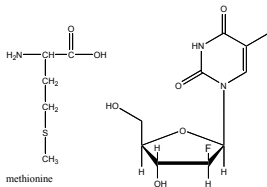

FIAU
2-fluoro-2'-deoxy-1-β-D-arabinofuranosyl-5-[¹²⁵I]-uracil

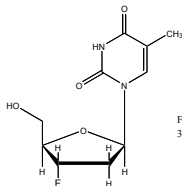

FLT
3'-deoxy-3-fluoro-[¹⁸F]-L-thymidine

Principy nukleárního zobrazování

Radioaktivita

Radioaktivní rozpad

Produkce radionuklidů

Cyklotron

Radiofarmaka

Podávání a konstrukce radiofarmak

Přehled radioizotopů

Gama kamera

SPECT

PET

Klinické aplikace PET

Kyslík, izotop ^{15}O

- Poločas rozpadu ^{15}O je 2.5 minuty.
- **Oxid uhličitý (CO_2)** — tok krve v mozku
- **Kyslík (O_2)** — spotřeba kyslíku v myokardiu, nekróza nádorů
- **Voda (H_2O)** — prokrvení myokardia
 - + není ovlivněno metabolismem
 - aktivita ^{15}O v plicích a cévách znesnadňuje měření

Dusík, izotop ^{13}N

- Poločas rozpadu ^{13}N je 10 minut.
- **Amoniak** (NH_3) — tok krve, prokrvení myokardia;
 - v tkáních je metabolizován

Uhlík, izotop ^{11}C

- Poločas rozpadu ^{11}C je 20.4 minut.
- **Acetát/octan** (CH_3COOH) — metabolické procesy myokardia
- **Kokain, carfentanil,...** — mechanismy opiátových receptorů v mozku
- **Deprenyl** — enzym, pro studium Parkinsonovy choroby
- **Leucin, methionine...** — aminokyseliny; spotřeba aminokyselin, pro vyhodnocení aktivity nádorů
- ...

Fluor, izotop ^{18}F

- Poločas rozpadu ^{18}F je 109 minut.
- **Haloperidol** — antipsychotická a uklidňující droga; studium mechanismu účinků
- **Aniont** $^{18}\text{F}^-$ — kosti
 - + Lepší kontrast kost/měkká tkáň v porovnání s ^{99m}Tc
 - Nerozliší maligní a benigní nádory
- **Fluorodeoxyglukóza (FDG)** — studium metabolismu glukózy ; neurologie, kardiologie, onkologie
- **Fluorodopa, fluoroethylspiperon. . .** — studium neurotransmise, metabolismu, buněčných procesů,
- **Flourouracil. . .** — dávkování chemoterapeutik

Rubidium, izotop ^{82}Rb

- Poločas rozpadu ^{82}Rb je 1.25 minut.
- + Produkován generátorem (není potřeba cyklotron)
- Dlouhý dosah pozitronu \rightarrow špatné prostorové rozlišení
- + Krátký poločas rozpadu \rightarrow rychlá odezva
- Krátký poločas rozpadu \rightarrow citlivý tomograf nutný
- Studium perfuse myokardu; využijeme rychlou odezvu
- Studium mozko-krevní bariéry

Principy nukleárního zobrazování

Radioaktivita

Gama kamera

SPECT

PET

Klinické aplikace PET

Závěr

Single Photon Detection with Gamma Camera

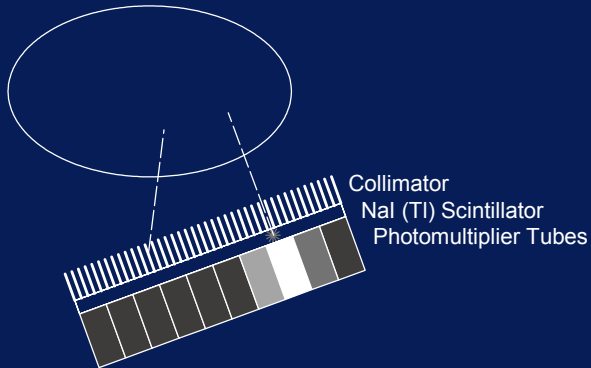

Terminology

- Hot and cold spots: regions with high and low uptake
- Static and dynamic image
- Phantom: test object filled with radio-activity, used for quality control and research
- Scintillator: material that generates light flashes when photons interact with it
- Dead time: time the camera needs to recover from a detection event in order to detect the next event
- Maximum count rate: determines how many photons per second can be processed by the camera

Photomultiplier tubes

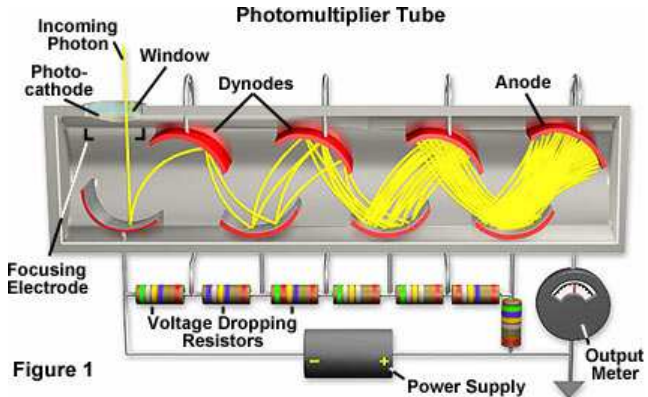
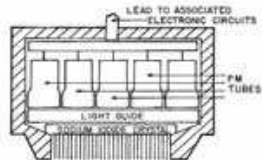

Figure 1

Scintillation detectors

- The γ -quantum (photon) interacts (photo-effect) with the crystal, resulting in a scintillation (light flash). The resulting amount of light photons is proportional with the energy of the γ -quantum.
- Oldest type of radiation detectors (Rontgen)
- A scintillation detector consists of a scintillator and an amplification device (PMT) that converts light into electrical signal



Materiály scintilačních detektorů

Scintillator	Density (g cm ⁻³)	Effective Z	Relative light yield	Decay constant (ns)	Wavelength of emission (nm)
Sodium Iodide (NaI)	3.67	50	100	230	410
Bismuth Germanate (BGO)	7.13	74	12	300	480
Barium Fluoride (BaF ₂)	4.89	54	5 15	0.6 - 0.8 630	220 (195) 310

- Nejčastěji BGO
- Záleží-li na rychlosti, pak BaF₂

Spatial Resolution and Sensitivity— Parallel Hole Collimator

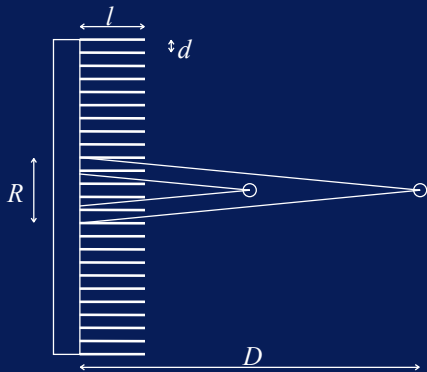

Photon's View

$$R \propto \frac{dD}{l}$$

$$\text{Sensitivity} \propto \frac{d^2}{l^2}$$

Attenuated Event

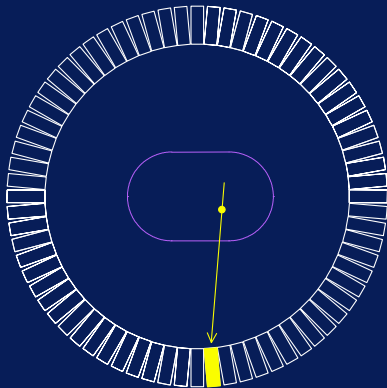

Principy nukleárního zobrazování

Radioaktivita

Gama kamera

Artefakty

Klinické aplikace

SPECT

PET

Klinické aplikace PET

Závěr

Artifacts: scattering

Scattering of photons in patient

- Because of limited energy resolution of the detector, primary and scattered photons which pass the collimator can not be classified properly. (In the ideal case, only primary photons are used to contribute to the image)
- Effects: haziness of images, quantization is degraded.

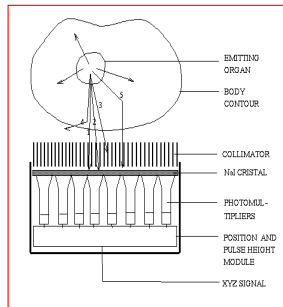

Artifacts: collimator blur



Collimator blur

- Because of the size of the holes, photons which are not entering the detector exactly perpendicular to the detector surface are also detected. This introduces uncertainty about the exact path the photon traveled.
- Effect: blurring which increases with larger holes. Trade off between sensitivity and resolution has to be found.

Artifacts: noise

Noise due to limited number of detected photons

- Doses and scanning time are limited while the efficiency of the collimator is also limited.
- Effects: Noise in the images. Low pass digital filtering required. This results in reduced resolution. Tradeoffs between dose, scanning time and collimator hole size have to be made.

Phantom experiments



Ground truth phantom

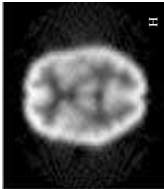
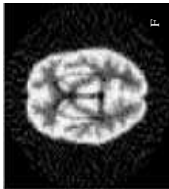

Detector + attenuation

Detector + attenuation + scatter

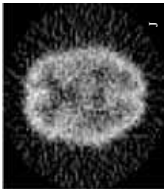
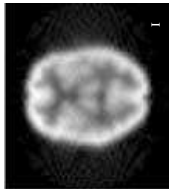

Detector + attenuation + scatter + noise

Principy nukleárního zobrazování

Radioaktivita

Gama kamera

Artefakty

Klinické aplikace

SPECT

PET

Klinické aplikace PET

Závěr

Scintigram

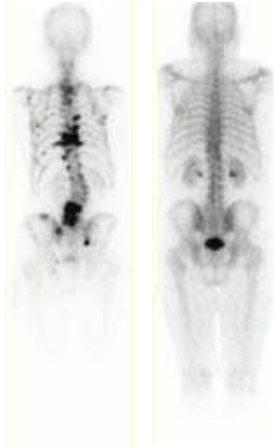

Scintigrafie plic

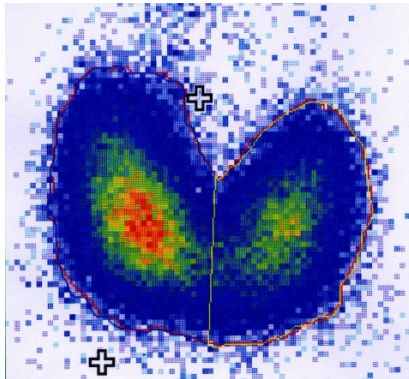

Gamma Camera Image

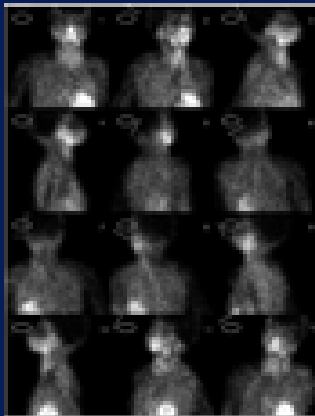

Principy nukleárního zobrazování

Radioaktivita

Gama kamera

SPECT

PET

Klinické aplikace PET

Závěr

SPECT

Single Photon Emission Computed Tomography (SPECT)

Image is acquired by rotating the γ -camera around the patient and taking images at different angles



SPECT

- Patient is injected with a γ -emitting radio-pharmaceutical
- Preferred energy: 100-250 keV
- Use of collimators
- Collimated camera projections are acquired from different equidistant angles (30-120 projections over 180-360 degrees)
- Images are reconstructed using Filtered Back Projection (FBP) or Iterative Reconstruction
- Resolution: 12-20 mm
- To increase count-rate often two or three γ -camera heads are used

SPECT Cameras



SPECT



Medical Image Formation Biomedical Image Sciences 2005 - 2006

Image Reconstruction Methods



(28 Subsets)

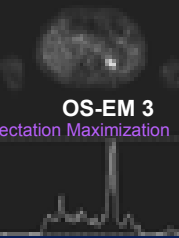

SPECT, Snímání mozku



Principy nukleárního zobrazování

Radioaktivita

Gama kamera

SPECT

Princip

Klinické aplikace

PET

Klinické aplikace PET

Závěr

SPECT: Applications

Cardiac Imaging

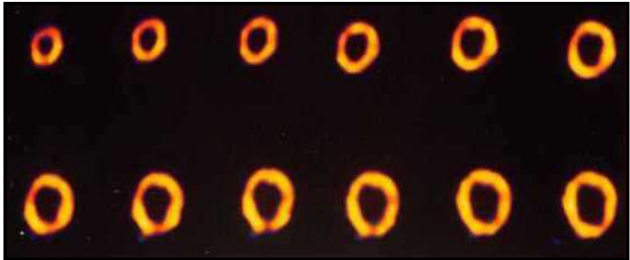

SPECT: Applications



Brain imaging

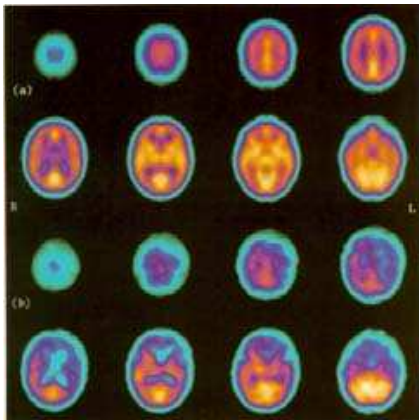

SPECT: Applications

Epilepsy

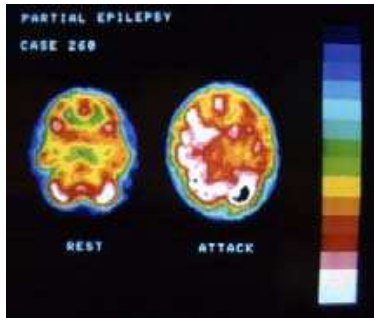

SPECT, Celotělové snímání

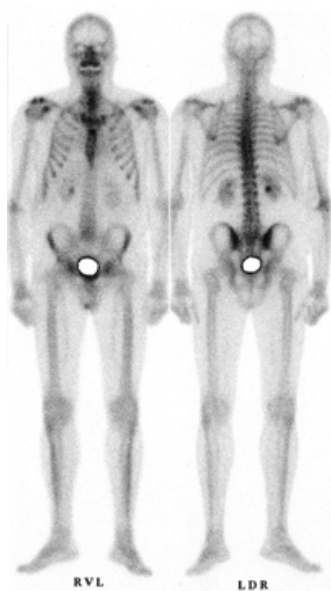

SPECT, Celotělové snímání

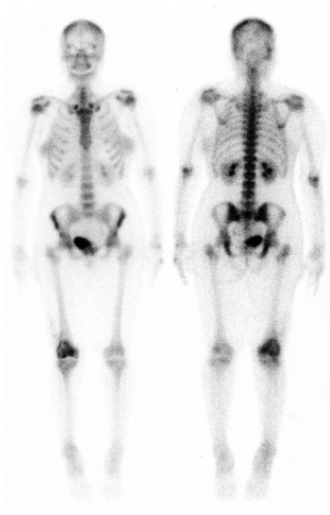

Zvýšená aktivita v kolenu.

Principy nukleárního zobrazování

Radioaktivita

Gama kamera

SPECT

PET

Klinické aplikace PET

Závěr



PET

- PET = Positron Emission Tomography
- Radiopharmaceutical is labeled with positron emitter
- Positrons annihilate with electrons close to the position of the emission (few mm).
- As a result, two 511 keV γ 's are created which move in opposite direction ($E=mc^2$)
- γ -rays are detected, most times in a ring-shaped detector

Positron Emission Tomography

Radionuclides that emit positrons such as ^{15}O and ^{18}F are introduced into the brain.

H_2^{15}O behaves like H_2^{16}O and indicates blood flow (rCBF) (half life = 123 seconds) integration time \approx 60 seconds.

^{18}F – deoxyglucose behaves like deoxyglucose and indicates metabolic activity (half-life = 110 minutes) integration time \approx 20 minutes



PET SCANNER

From: www.epub.org.br/cm/n011pet/pet.htm



Principle of PET

A₁ Positron emission in the brain

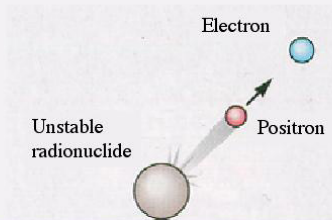

A₂ Positron and electron annihilation and emission of gamma rays

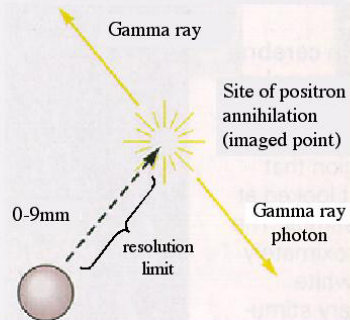

From: Principles of Neural Science (4th. Ed.) Kandel, Schwartz, & Jessell, p. 377.



PET: annihilation

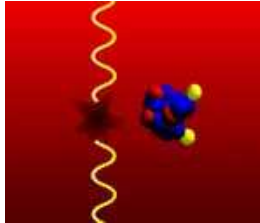
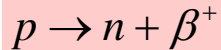

Annihilation
Coincidence
Detection

Isotope	Maximum Positron Range (mm)
F-18	2.6
C-11	3.8
Ga-68	9.0
Rb-82	16.5

Positron Annihilation

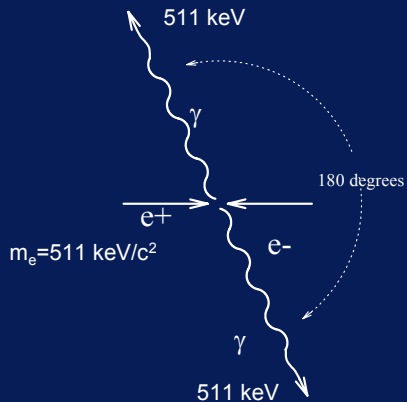

Princip PET (2)

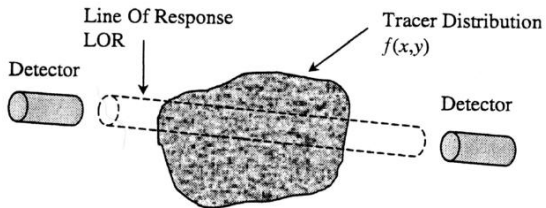

Gamma Ray Detections to Location of Function

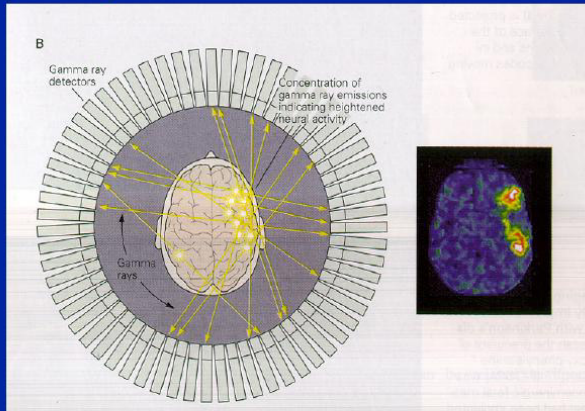

From: Principles of Neural Science (4th. Ed.) Kandel, Schwartz, & Jessell, p. 377.



Commercially Available PET/CT



Bactrian



Dromedary

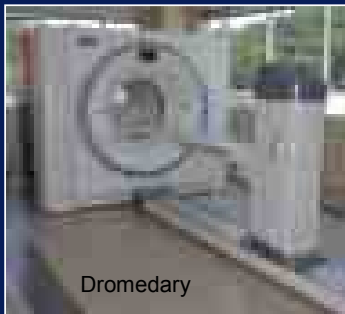

Dromedary

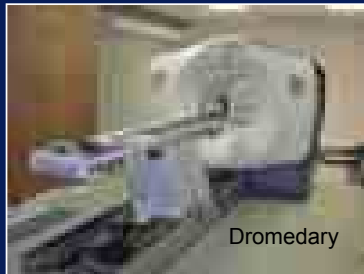

Dromedary

PET

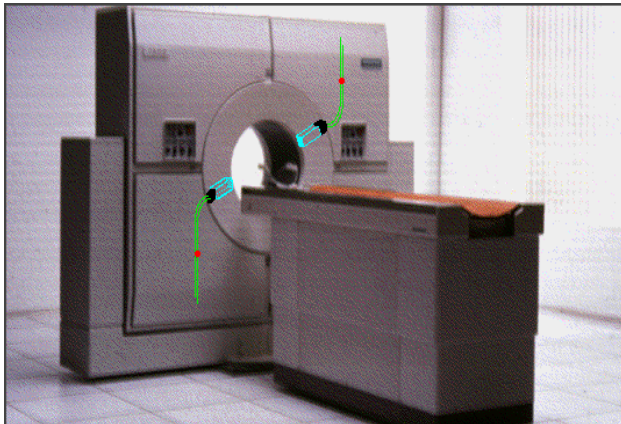

Medical Image Formation Biomedical Image Sciences 2005 - 2006

PET

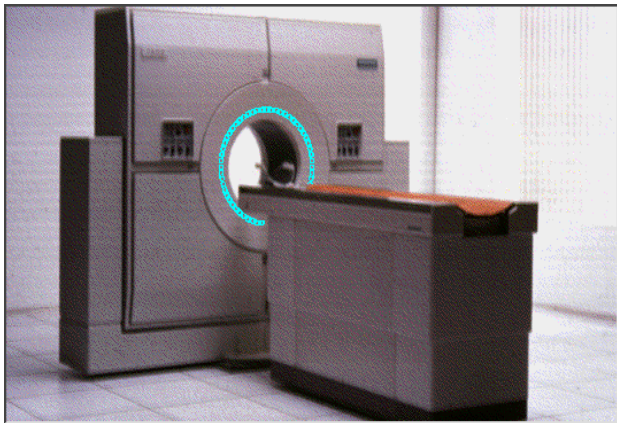

Medical Image Formation Biomedical Image Sciences 2005 - 2006

PET

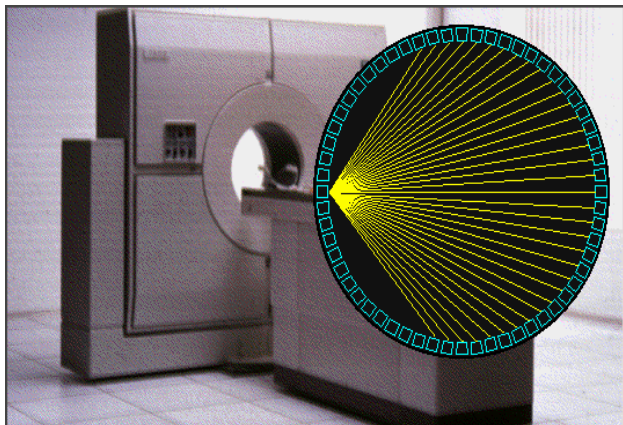

Medical Image Formation Biomedical Image Sciences 2005 - 2006

PET

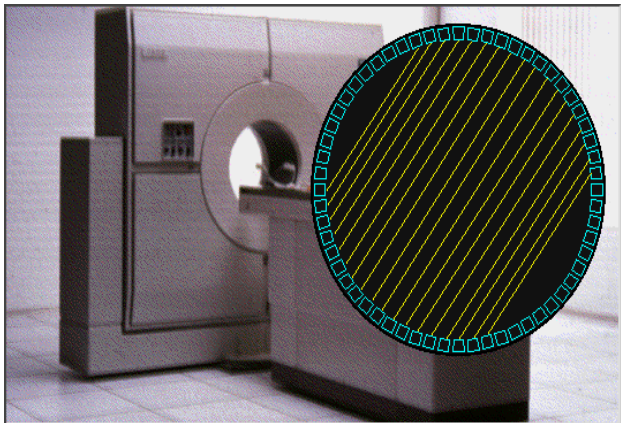

Medical Image Formation Biomedical Image Sciences 2005 - 2006

Projections

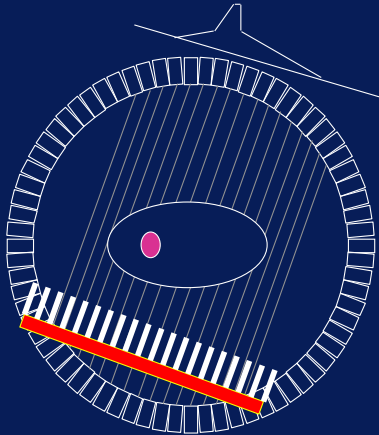

PET

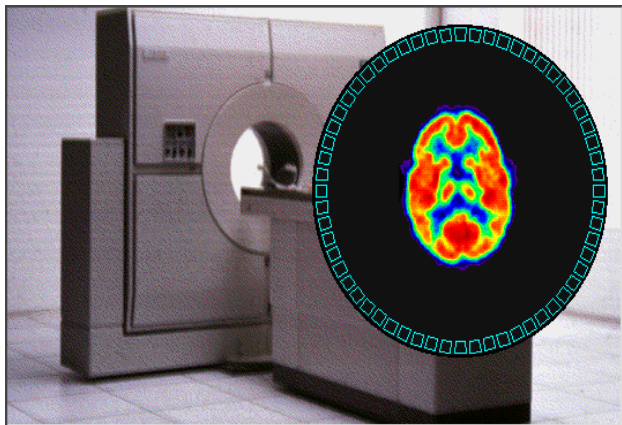

Medical Image Formation Biomedical Image Sciences 2005 - 2006



PET: Electronic collimation

- When the photons are detected, an electronic coincidence circuit determines if the two photons originate from the same annihilation. Then, the line where the annihilation has occurred is known (Line of Response (LOR)).
- Typical resolution: 5-8 mm
- PET-systems are not equipped with lead collimators. This results in a very high sensitivity compared to SPECT, but requires a very high count rate.

Coincidence Event

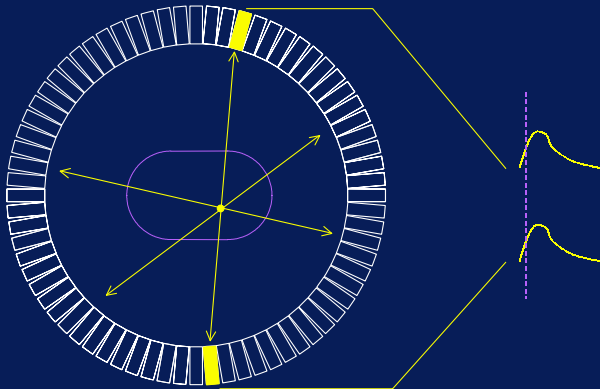

Multiple Rings, 2D – 3D

For n detector rings:

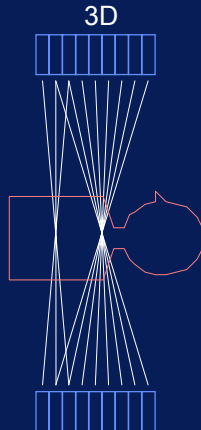
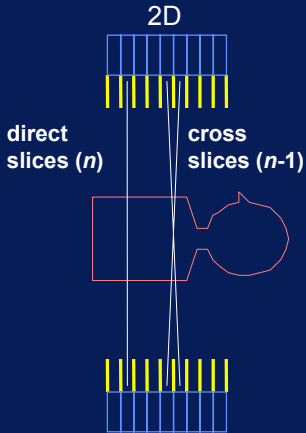

total slices = $2n-1$

Principy nukleárního zobrazování

Radioaktivita

Gama kamera

SPECT

PET

Princip

Artefakty a korekce

CT + PET/SPECT

PET versus SPECT

TOFPET

Klinické aplikace PET

Závěr

Scattered Coincidence Event

In-Plane

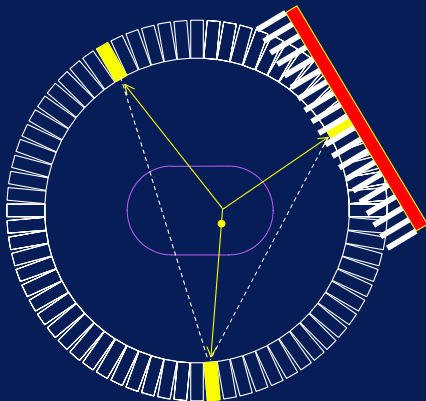

Out-of-Plane

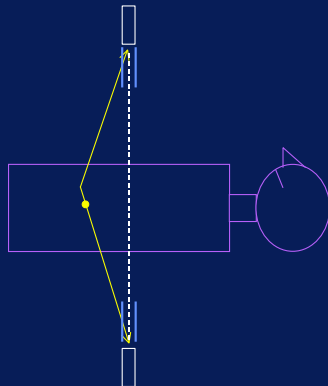

Scatter Fraction $S/(S+T)$

With septa ~10-20%

w/o septa ~30-80%

Random Coincidence Event

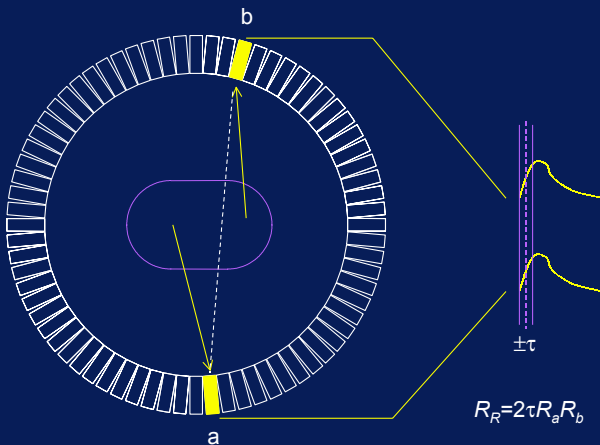

Correcting Background, Noise Equivalent Counts

$$P_{\text{prompts}} = T_{\text{trues}} + S_{\text{scatter}} + R_{\text{randoms}}$$

$$T' = P - S' - R'$$

$$NEC = \frac{T^2}{P} = \frac{T}{(1 + S/T + R/T)}$$

More background → more statistical image noise.

Nefunkční detektor

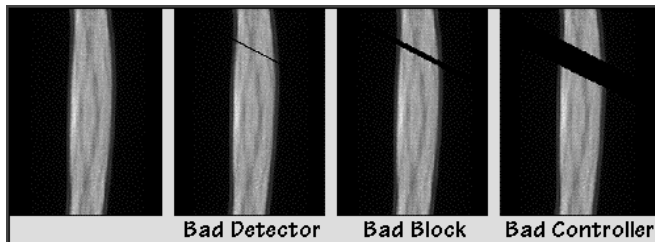

Sinogram

Nefunkční detektor

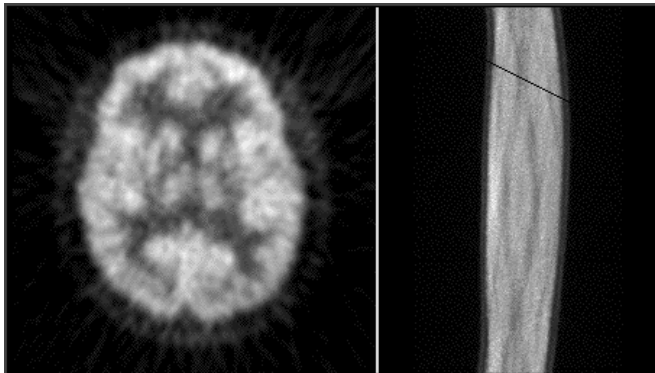

Rekonstrukce

Chyba rekonstrukčního hardware

Fantom:

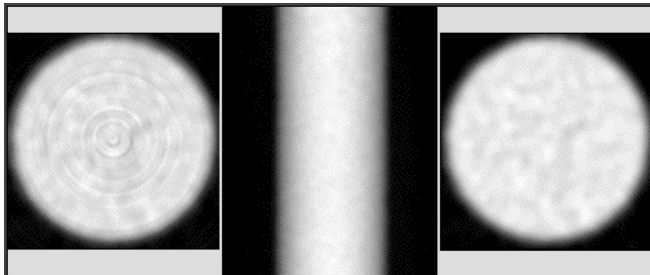

HW rekonstrukce

Sinogram

SW rekonstrukce

Sejmutí fantomu by mělo být částí denní kontroly.

Pohyb pacienta

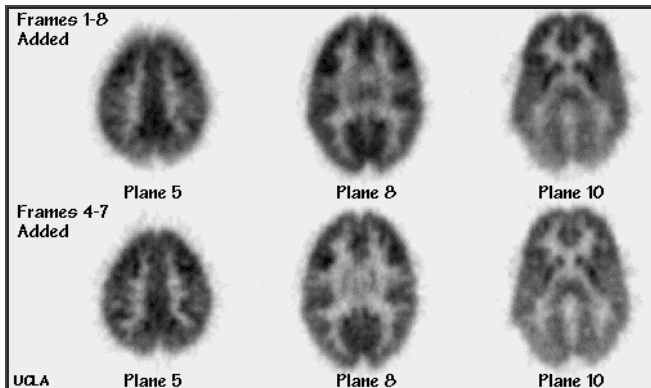

Spodní řada používá jen obrázky bez pohybu.

Patient Size Variations

136 kg

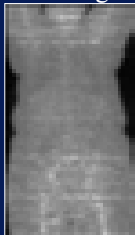

80 kg

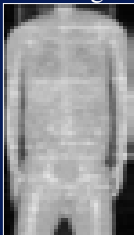

53 kg

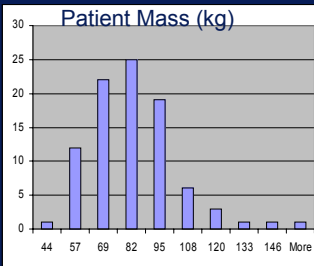
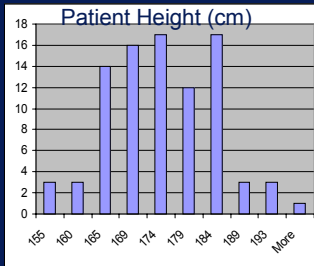
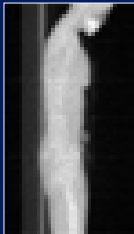
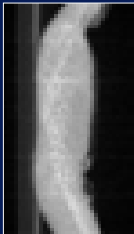
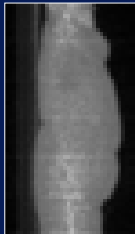
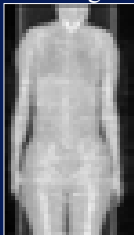

Coincidence Attenuation

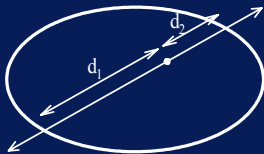

$$\begin{aligned}P_C &= P_1 P_2 \\&= e^{-\mu \cdot d_1} e^{-\mu \cdot d_2} \\&= e^{-\mu \cdot (d_1 + d_2)}\end{aligned}$$

Annihilation radiation emitted along a particular line of response has the same attenuation probability, regardless of where it originated on the line.

Attenuation Effects

AC

NAC

x-ray CT

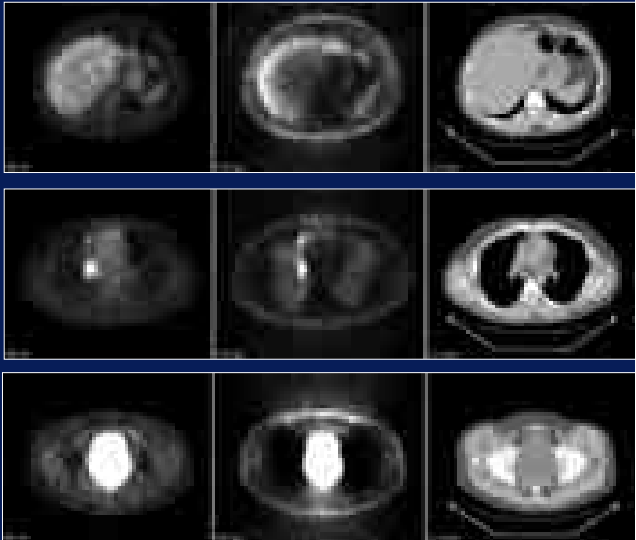

Calculated Attenuation Correction

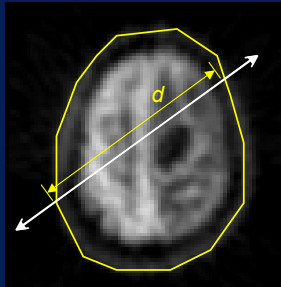

$$I = I_0 e^{-\mu d}$$

Transmission Attenuation Measurement

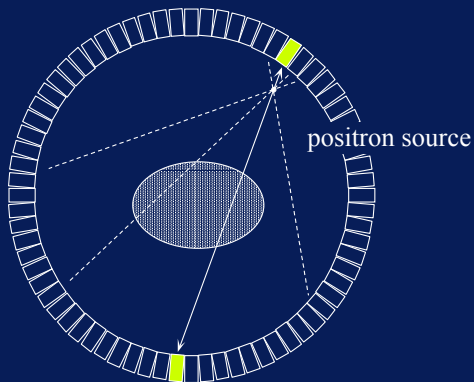

Špatná korekce útlumu

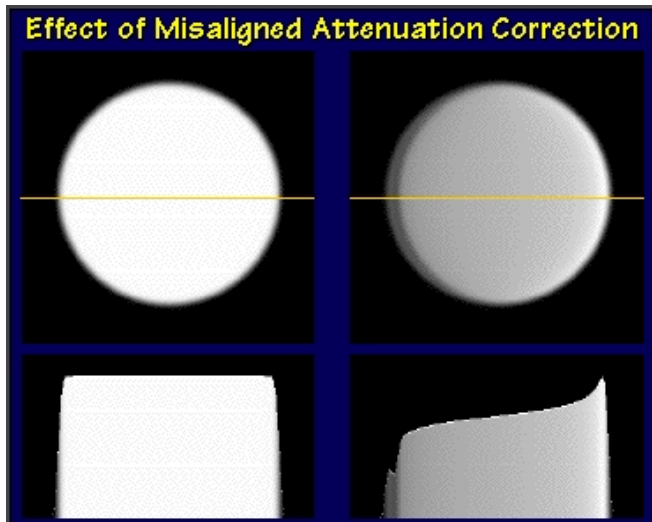

Špatné umístění.

Špatná korekce útlumu

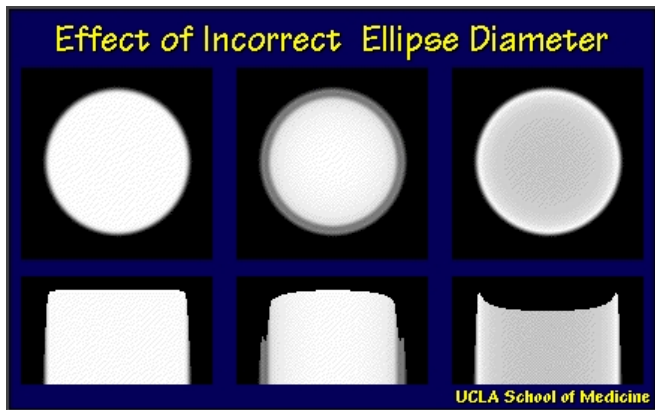

Špatný rozměr elipsy.

Špatná korekce útlumu

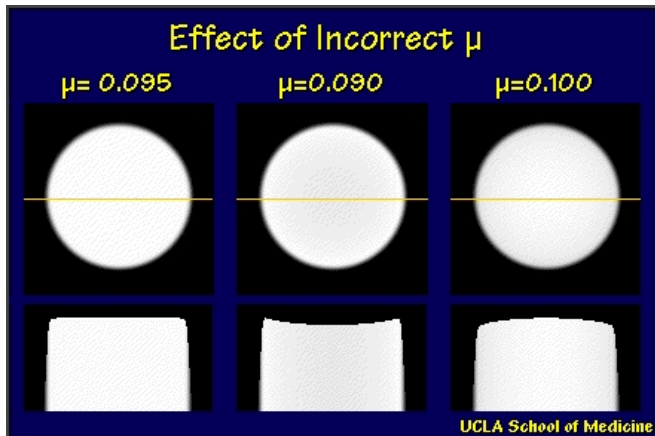

Špatný korekční parametr.

Špatná korekce útlumu

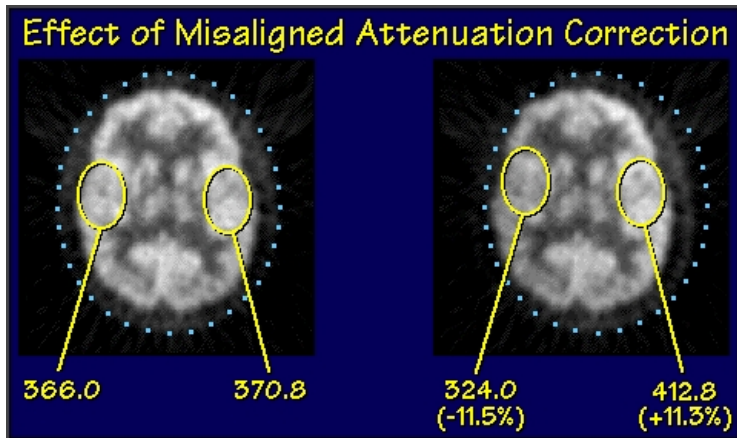

Operátor umístí elipsu na obrys hlavy.

Špatná korekce útlumu

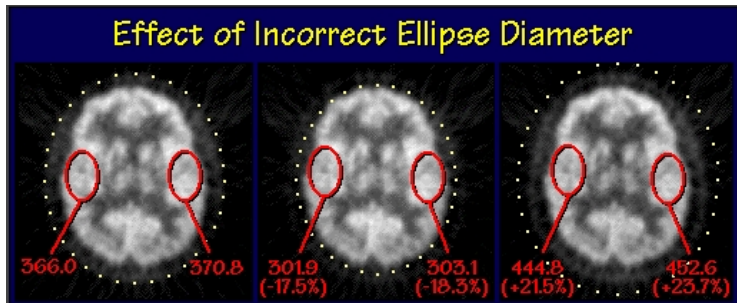

Špatný rozměr elipsy.

Principy nukleárního zobrazování

Radioaktivita

Gama kamera

SPECT

PET

Princip

Artefakty a korekce

CT + PET/SPECT

PET versus SPECT

TOFPET

Klinické aplikace PET

Závěr

Combining x-ray CT with ECT

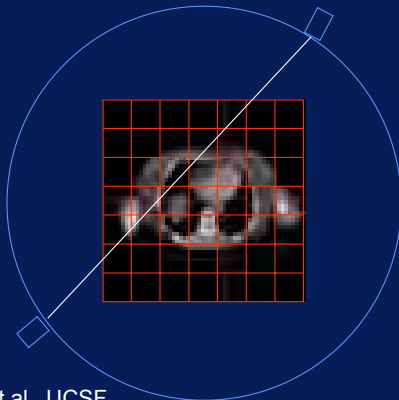

SPECT/CT:
Hasegawa BH, et al., UCSF

PET/CT:
Townsend DW, et al., U. Pittsburgh

SPECT/CT

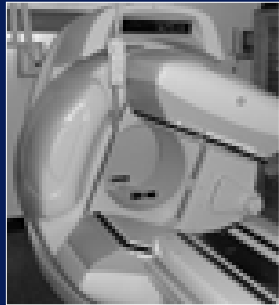
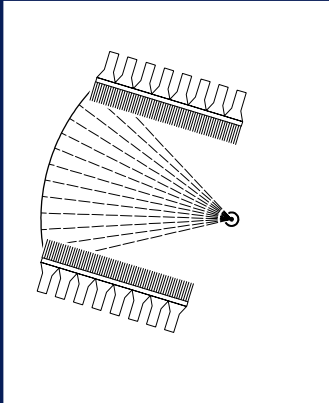

Converting Attenuation Map from Hounsfield to 511 keV attenuation Coefficients

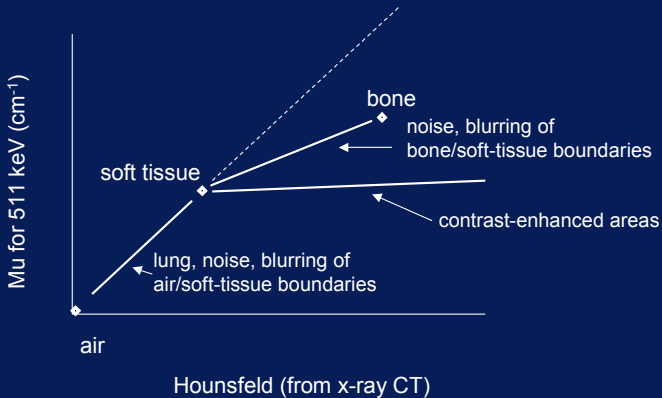

Principy nukleárního zobrazování

Radioaktivita

Gama kamera

SPECT

PET

Princip

Artefakty a korekce

CT + PET/SPECT

PET versus SPECT

TOFPET

Klinické aplikace PET

Závěr

PET vs. SPECT

- For several radio-nuclides like C11 ($T_{1/2} = 20$ min) and N13 ($T_{1/2} = 10$ min) a cyclotron in the hospital is needed. The advantage of the radio-nuclides made out of these elements is that they occur in biologically active molecules
- Dedicated PET is very expensive compared to SPECT, especially when combined with a cyclotron.
- PET and SPECT are complementary: you want them both

Spatial Resolution Limits

- PET

- positron range
- opening angle
- detector size**
- depth of interaction**

- SPECT

- Intrinsic Camera Resolution**
- Collimator Resolution**

(Image Noise)

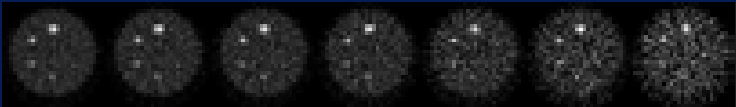

PET — parametry

- Intrinsické rozlišení ≈ 6 mm, 8 ~ 10 mm výsledný obraz
- Vzorkování 3 mm isotropně
- Transaxiální FOV 60 cm, axiálně 10 cm. Zvětšení axiálního FOV možné zvýšením počtu detektorů (=vyšší cena), nebo posunem pacienta.
- 16 rovin detektorů \rightarrow 31 rovin detekce
- Musí být schopné pracovat s velkým i malým počtem rozpadů, při zachování linearity.

Principy nukleárního zobrazování

Radioaktivita

Gama kamera

SPECT

PET

Princip

Artefakty a korekce

CT + PET/SPECT

PET versus SPECT

TOFPET

Klinické aplikace PET

Závěr

Time of Flight PET

- Měříme navíc časový interval mezi koincidentními fotony

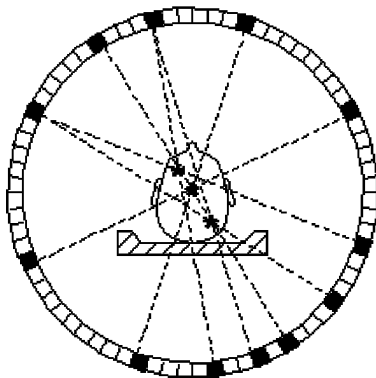

Principy nukleárního zobrazování

Radioaktivita

Gama kamera

SPECT

PET

Klinické aplikace PET

Onkologie

Plíce

Mozek

Funkcionální zobrazování

Kardiologie

Kinetické studie

Bone scanning

Bone scans are the second most frequent nuclear medicine procedure.

Clinical uses:

- **Detection of primary and metastatic bone tumors**
- **Evaluation of unexplained bone pain**
- **Diagnosis of stress fractures or other musculoskeletal injuries or disorders.**

E.g.,

Prostate cancer:

- **Incidence is rising**
- **Most common cause of death in males in many western countries**
- **Of prostate deaths, 85% have mets in bone**
- **60% of new cases have mets**
- **Bone metastases are painful and debilitating**
- **Diagnosis of bone mets is part of the staging process that determines treatment**

Breast cancer:

- **Bone is the most common site of metastasis**
- **8% of all cases develop bone mets**
- **70% of advanced cases experience bone mets**

PET, Celotělové snímání

Nádor má rychlejší metabolismus →
kontrastní látka se hromadí v kostech v místě nádoru.

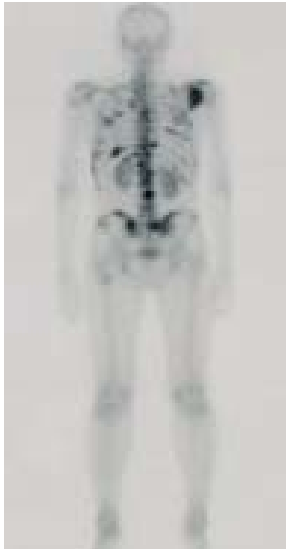

PET + FDG

^{18}F glukóza (FDG)

Normální obraz



Nádor v plicích



PET + FDG

^{18}F glukóza (FDG). Detekce nádorů.

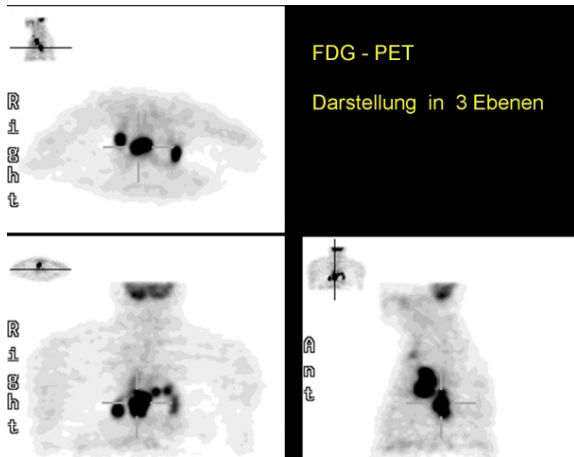

**Brain Tumor
FDG**

6 min, 3D



MRI, T1+C



FDG PET



Principy nukleárního zobrazování

Radioaktivita

Gama kamera

SPECT

PET

Klinické aplikace PET

Onkologie

Plíce

Mozek

Funkcionální zobrazování

Kardiologie

Kinetické studie

PET. Ventilace a perfuse plic

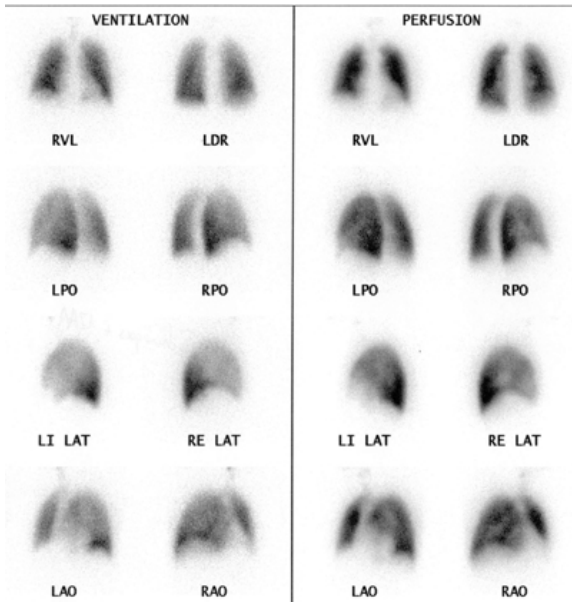

Principy nukleárního zobrazování

Radioaktivita

Gama kamera

SPECT

PET

Klinické aplikace PET

Onkologie

Plíce

Mozek

Funkcionální zobrazování

Kardiologie

Kinetické studie

PET, Hlava

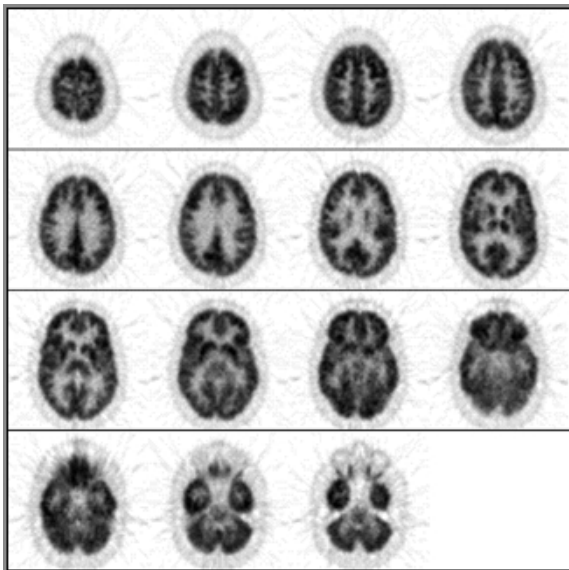

PET: Applications

Brain imaging

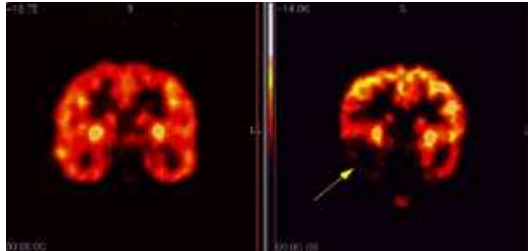

PET, mozek

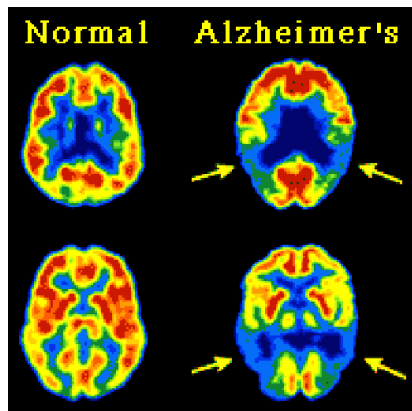

Alzheimerova choroba

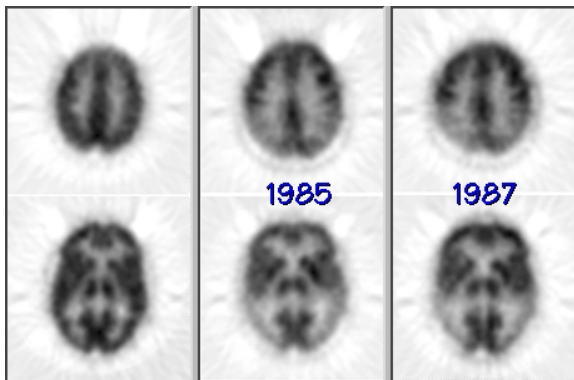

Hypometabolismus.

Parkinsonova choroba

^{18}F – DOPA PET vyšetření

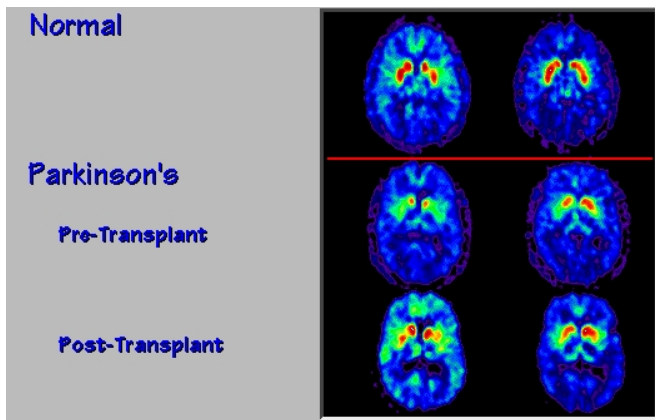

Transplantace buněk produkujících dopamin.

Mozek, nádor

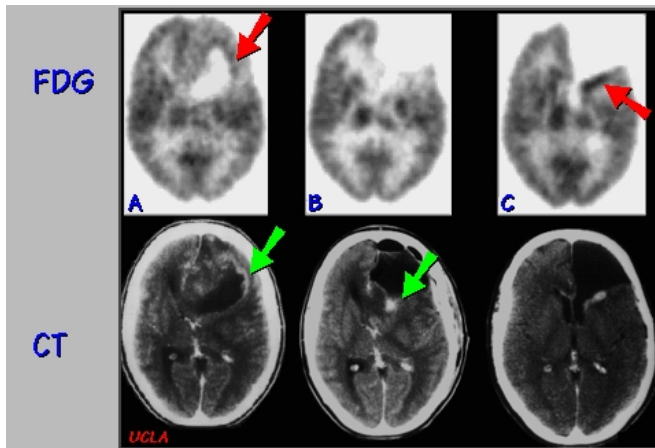

Efektivita chirurgického odstranění

PET, Huntingtonova choroba

Snížená spotřeba glukózy

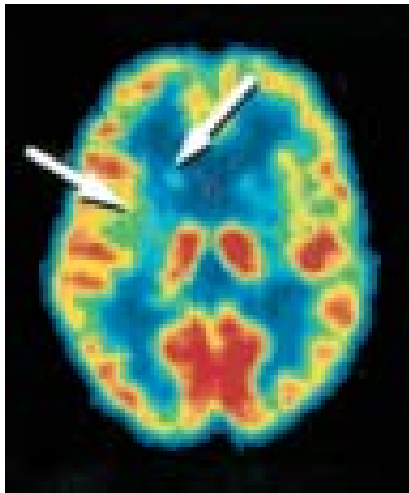

Vývoj mozku

FDG

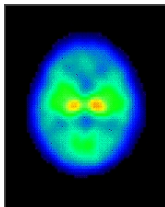

1 měsíc

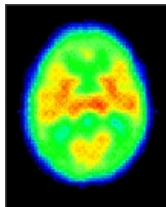

3 měsíce

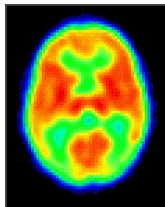

6 měsíců

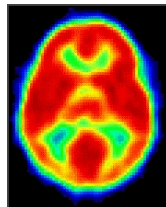

1 rok

Fusion of anatomical and functional data

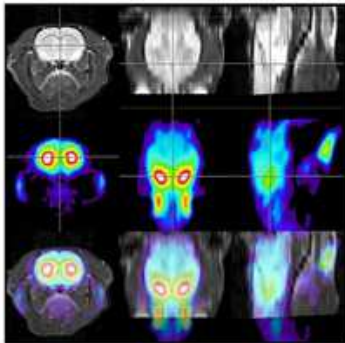

Top: MRI images of a rat brain (axial, multi-slice 256 sq x 16 acquisition, coronal/sagittal views are interpolated)

Center: ^{18}F -labeled specific ligand for the dopamin-transport protein. Compound accumulates in brain areas with a high level of dopamine containing neurons (striatum).

Bottom: Overlay in all three major directions.

Fusion of anatomical and functional data



Fusion
MRI & SPECT

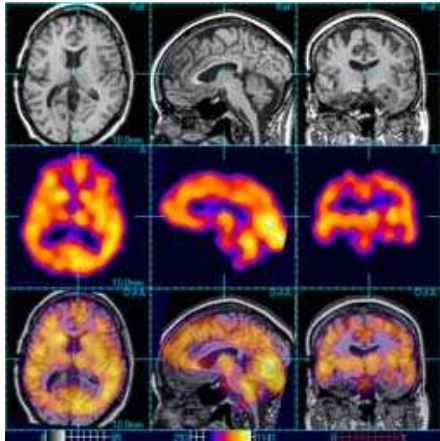

Fusion of anatomical and functional data

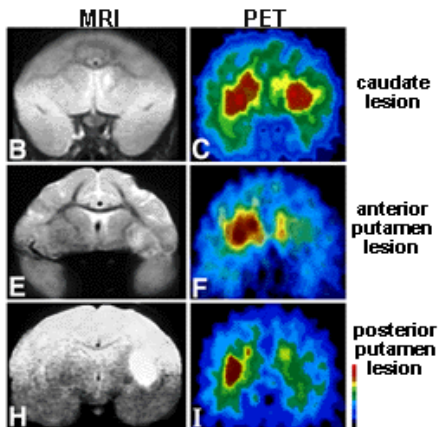
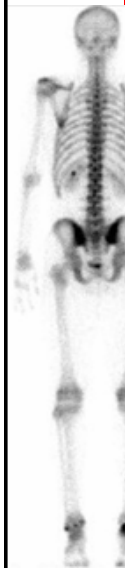

Principy nukleárního zobrazování

Radioaktivita

Gama kamera

SPECT

PET

Klinické aplikace PET

Onkologie

Plíce

Mozek

Funkcionální zobrazování

Kardiologie

Kinetické studie

PET: Applications

Functional imaging

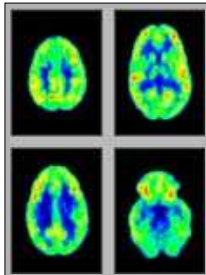

rest

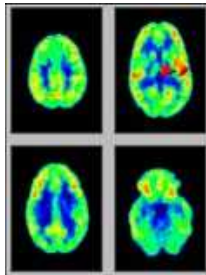

hear

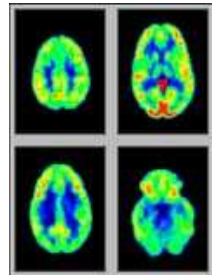

look

Možek v klidu

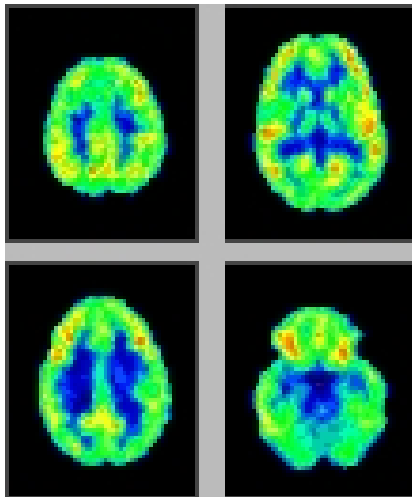

Zvuková stimulace

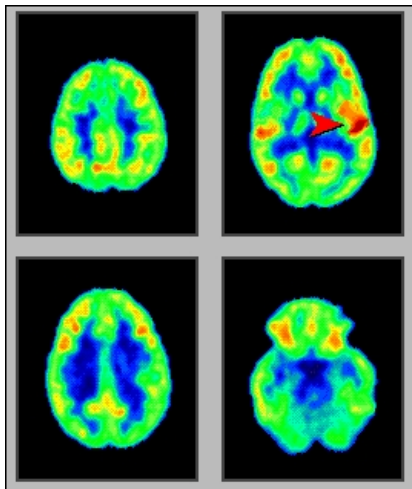

Vizuální stimulace

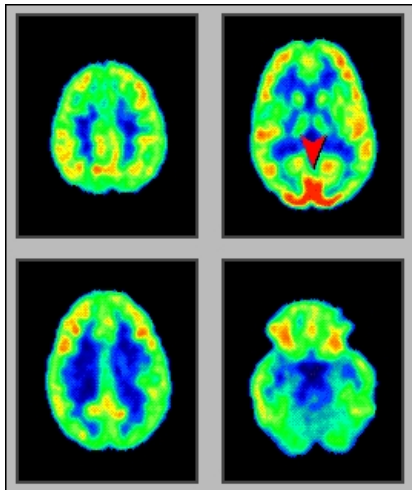

Myšlení

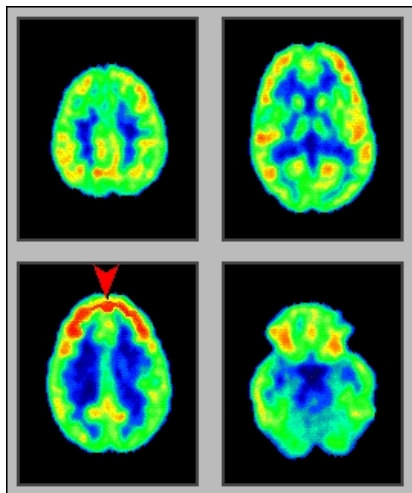

Paměť a učení

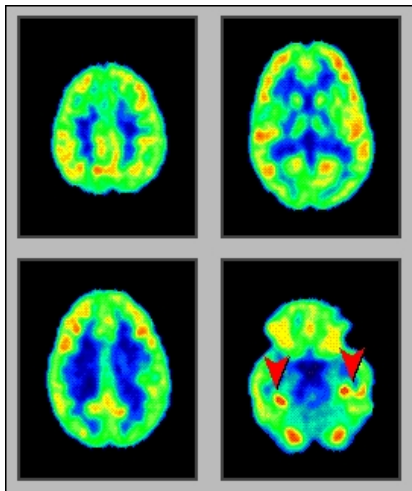

Zapamatování obrázku.

Pohyb

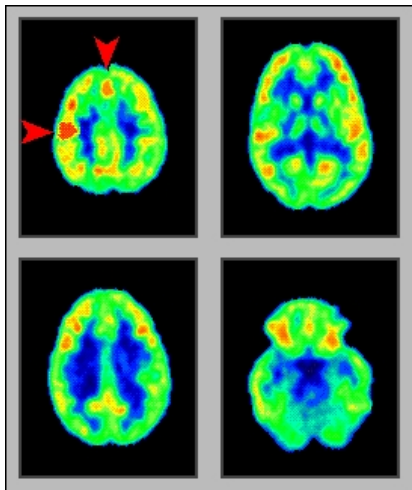

Pohyb nohy.

Principy nukleárního zobrazování

Radioaktivita

Gama kamera

SPECT

PET

Klinické aplikace PET

Onkologie

Plíce

Mozek

Funkcionální zobrazování

Kardiologie

Kinetické studie

PET: Applications

Cardiac imaging

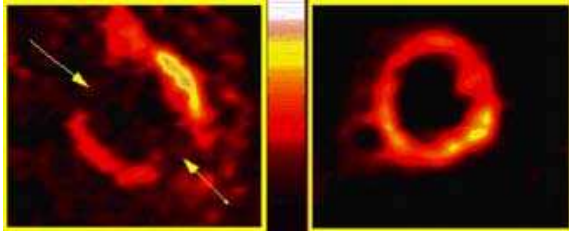

Coronary artery disease

Use PET and/or SPECT imaging to assess information on:

- perfusion
- metabolism
- distinguish viable from non-viable myocardium.

PET, Srdce

Kontrastní látka ^{201}Tl (thalium, chová se jako draslík) ukazuje, kde je prokrvení nedostatečné

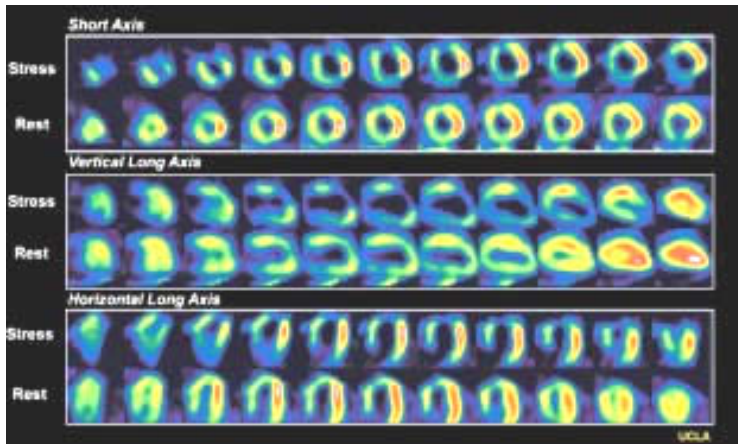

PET, Srdce

Kontrastní látka FDG

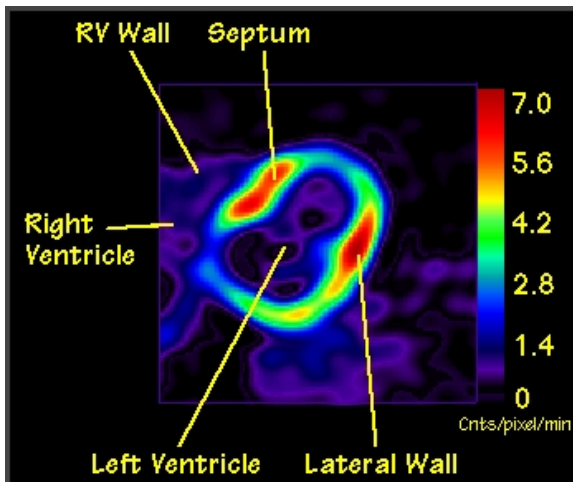

PET, Srdce

Kontrastní látka FDG

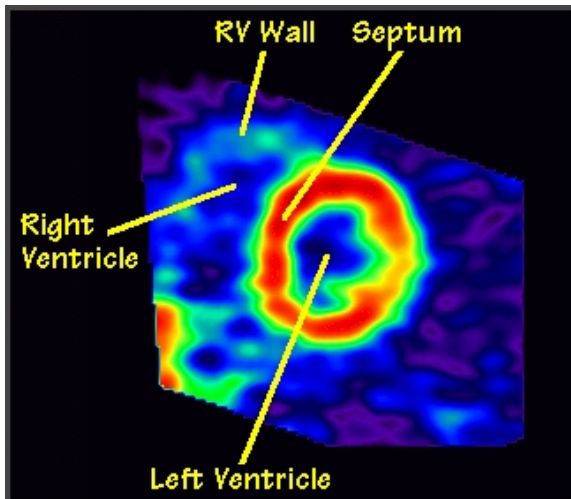

Reinterpolovaná data — short axis view

Srdeční segmenty

Kontrastní látka FDG

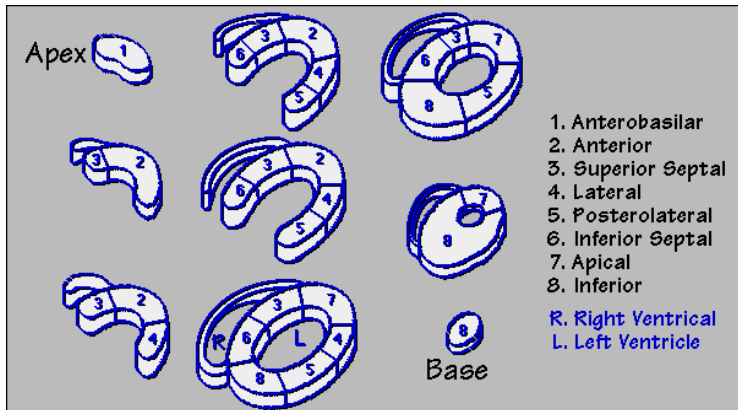

Srdce, diagnostika

Průtok (např. NH_3)

Metabolismus (např. FDG)

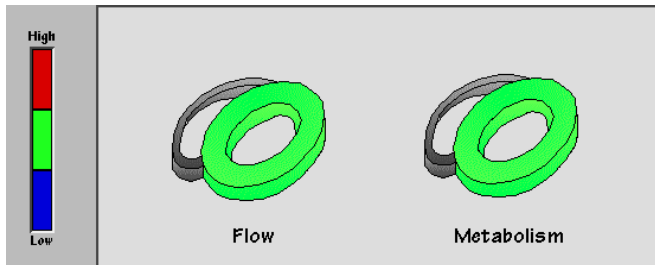

Normální.

Srdce, diagnostika

Průtok (např. NH_3)

Metabolismus (např. FDG)

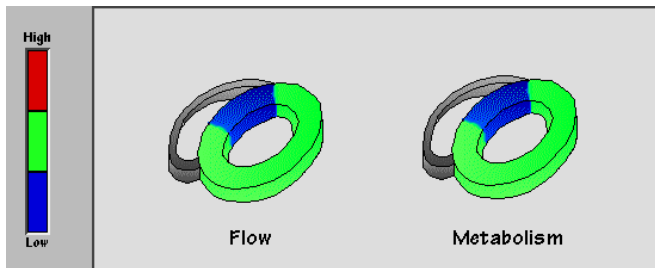

Nefunkční tkáň, léčba není možná.

Srdce, diagnostika

Průtok (např. NH_3)

Metabolismus (např. FDG)

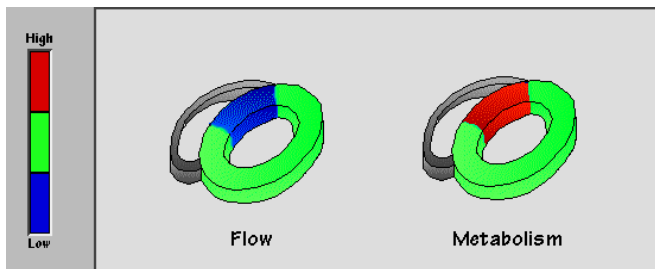

Potenciálně funkční tkáň, nedostatečné prokrvení. Léčba možná.

Srdce, diagnostika

Průtok (např. NH_3)

Metabolismus (např. FDG)

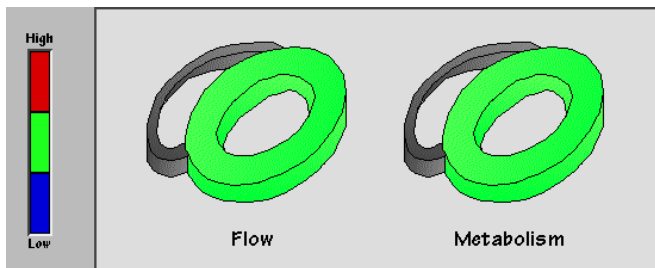

Idiopaticky (z neznámých důvodů) zvětšená levá komora. Léčba pouze transplantací.

Srdce, diagnostika

Průtok (např. NH_3)

Metabolismus (např. FDG)

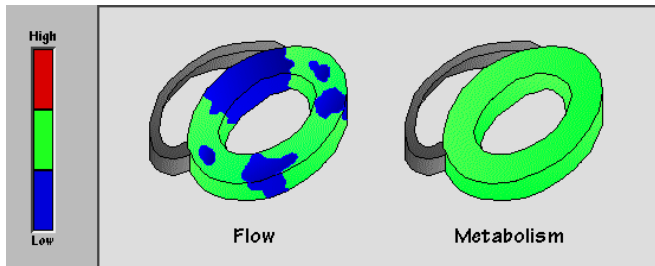

Špatné prokrvení (ischemie), zvětšené myokardium. Léčba možná, je-li metabolismus normální nebo zvýšený.

Srdce, diagnostika

Průtok v klidu

Průtok při zátěži

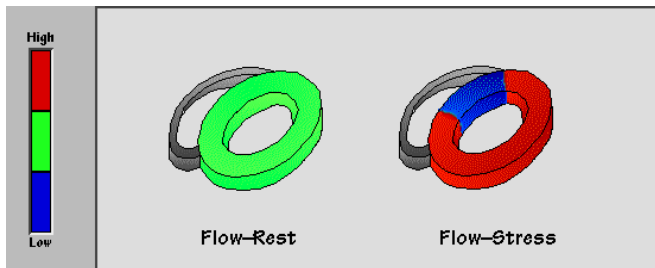

Zátěžový test odhalil špatné prokrvení.

Srdce, diagnostika

Metabolismus po půstu

Podání glukózy

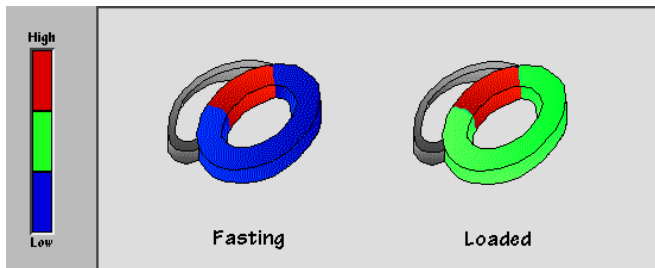

Ischemické myokardium spotřebovává glukózu rychleji.

Srdce, diagnostika

Průtok (např. NH_3)

Metabolismus (např. FDG)

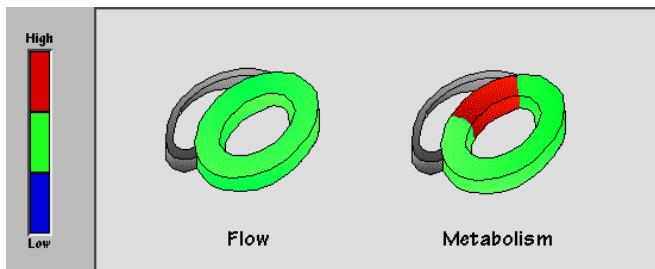

Hibernující myokardium např. po dříve nedostatečném prokrvení.

Principy nukleárního zobrazování

Radioaktivita

Gama kamera

SPECT

PET

Klinické aplikace PET

Onkologie

Plíce

Mozek

Funkcionální zobrazování

Kardiologie

Kinetické studie

Mozek

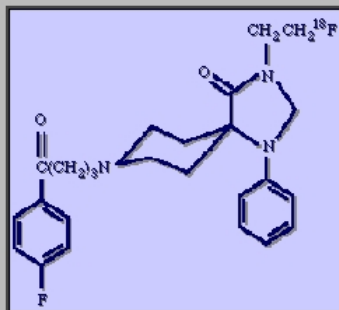

Fluoroethylspiperone

Mozek

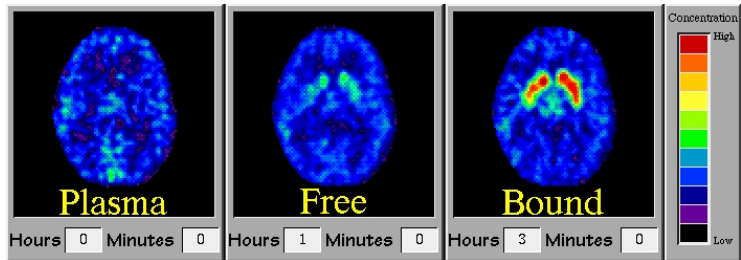

Srdce

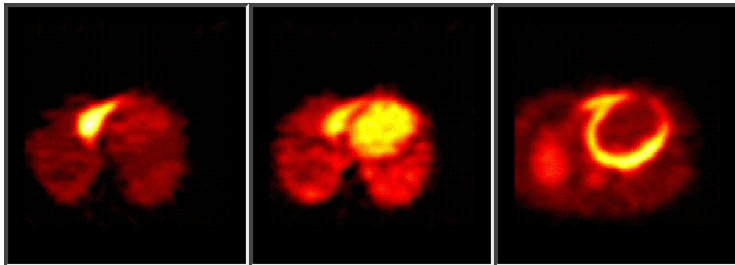

Srdce

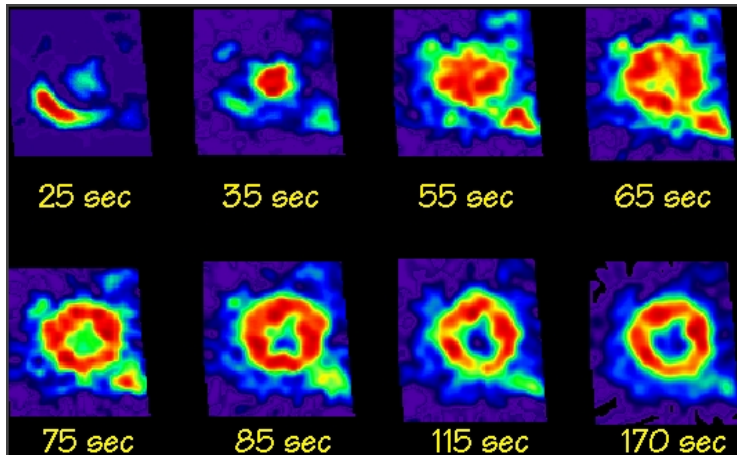

Srdce — oblastní analýza

ROI analysis

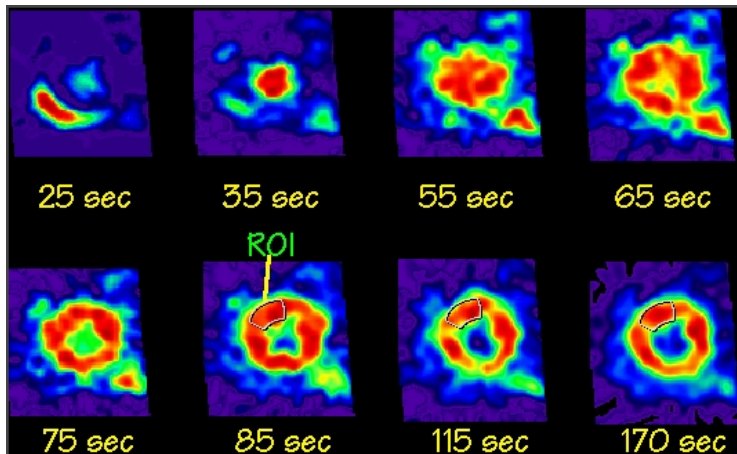

Srdce — oblastní analýza

ROI analysis

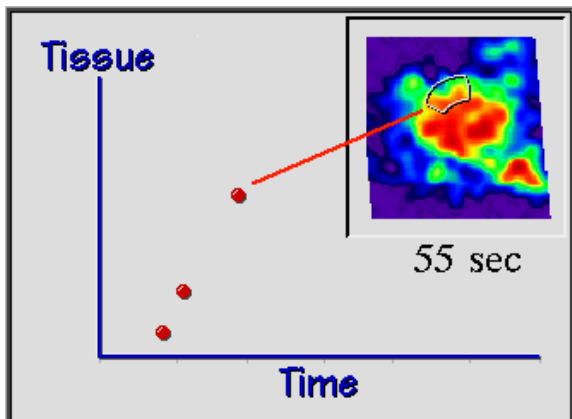

Srdce — oblastní analýza

ROI analysis

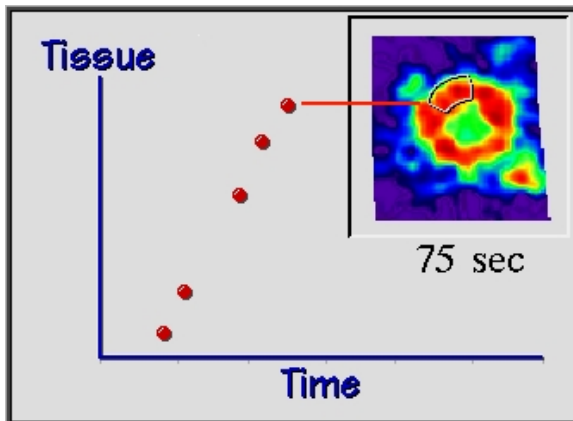

Srdce — oblastní analýza

ROI analysis

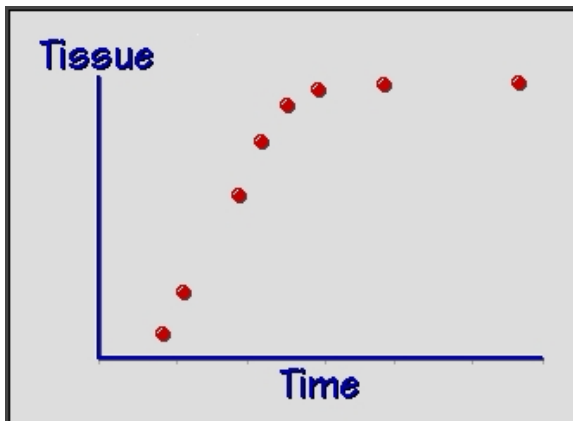

Srdce — oblastní analýza

ROI analysis

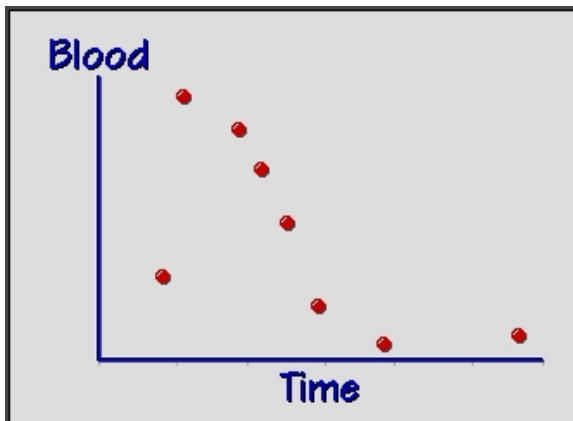

Kvalitativní × kvantitativní analýza

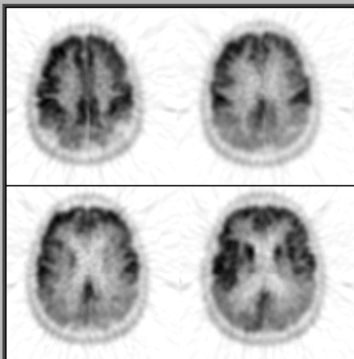

QUALITATIVE

"This pattern is characteristic of Alzheimer's Disease."

Approaches to Image Analysis

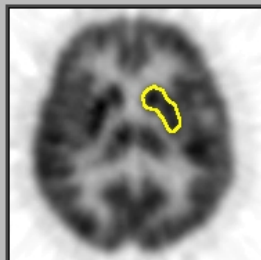

QUANTITATIVE

"Metabolic rate for glucose in this region is 8.37 mg/min/100g tissue"

Normalizovaný obraz radioaktivity

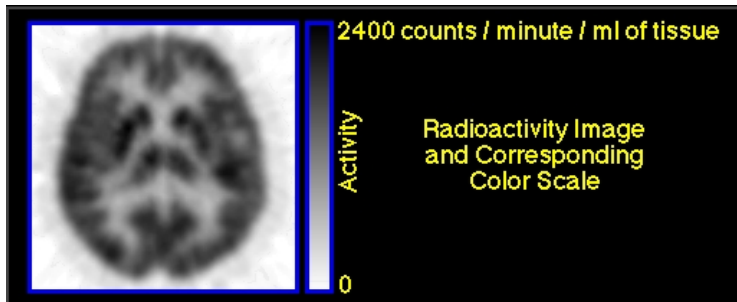

Střední regionální hodnota

Mean ROI value

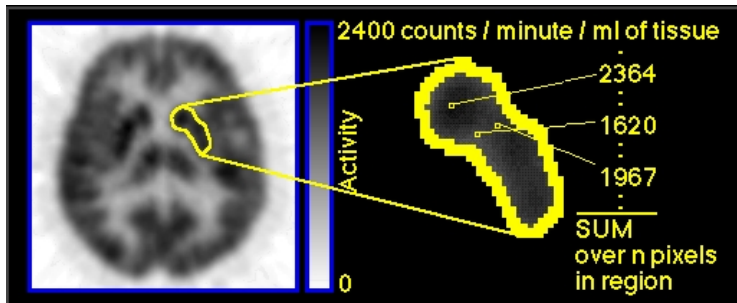

Regionální časový průběh

Time-activity ROI curve

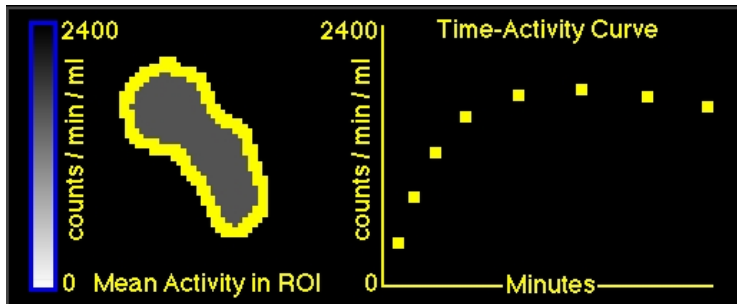

Normalizovaný regionální časový průběh

Normalized time-activity ROI curve

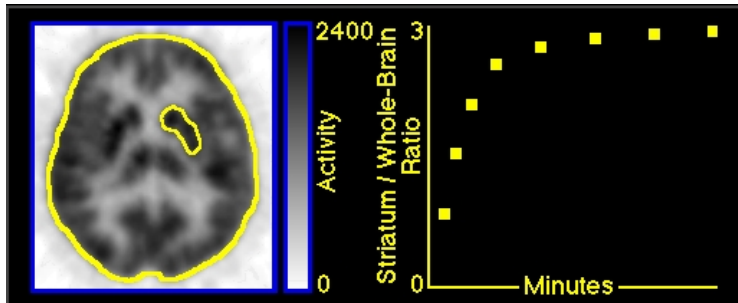

Poměr regionální a celkové aktivity

Identifikace parametrů časového průběhu

Tracer modeling of the ROI curve

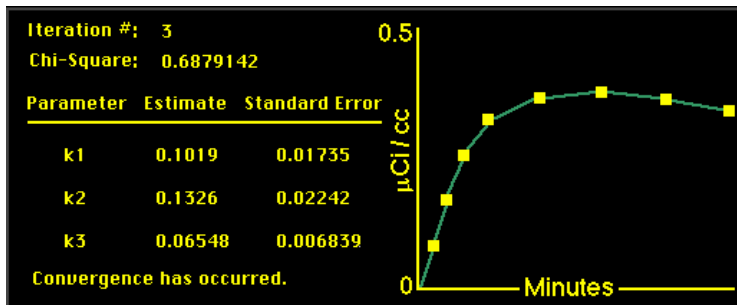

- Najdeme parametry biofyzikálního modelu — krevní průtok, koncentrace, rychlostní konstanty
- Často je potřeba měřit např. složení krve či plasmy.

Identifikace parametrů časového průběhu

Tracer modeling of the ROI curve

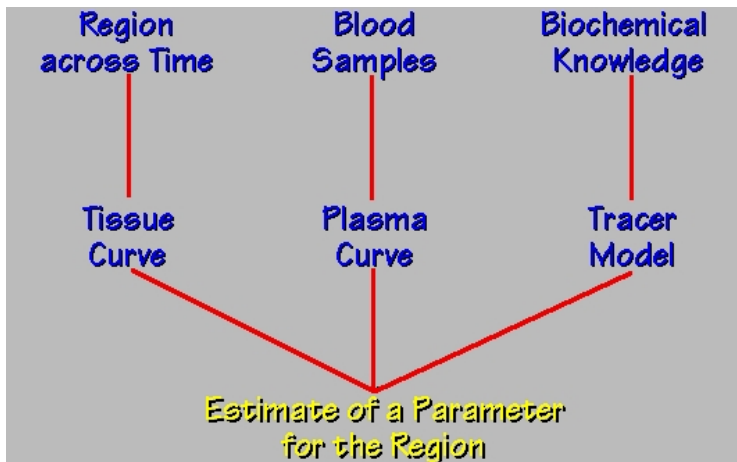

Identifikace parametrů časového průběhu

Tracer modeling of the ROI curve

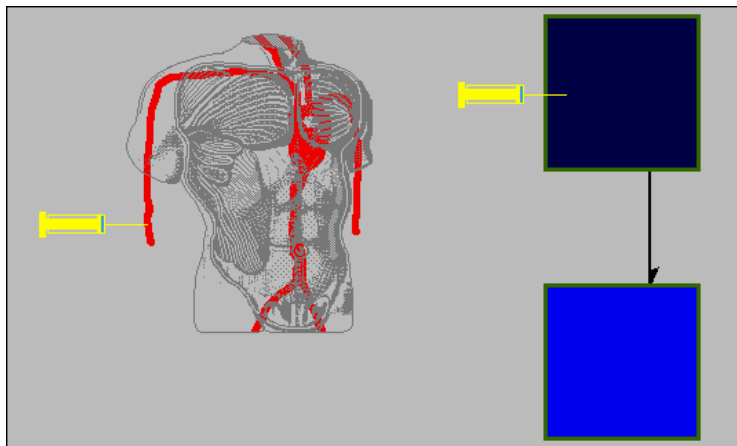

Identifikace parametrů časového průběhu

Tracer modeling of the ROI curve

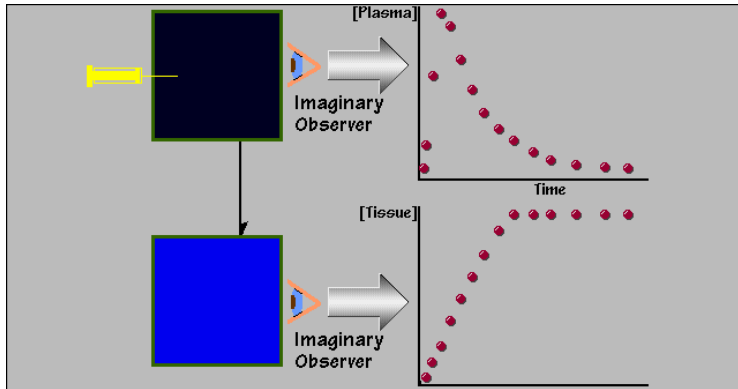

Vlastnosti metod kvantitativní analýzy

		Speed	Precision	Comparability	
				With Other PET Studies	With Other Kinds of Results
Analysis Approach	Radioactivity image	High	Poor	Difficult	Difficult
	Mean value in region of interest	Moderate	Fair	Impossible	Impossible
	Time-activity curve for ROI	Moderate	Fair	Crude	Impossible
	Normalized ROI curve	Moderate	Fair	Reasonable	Unlikely
	Tracer modeling of ROI curve	Low	Good	Excellent	Excellent

Nukleární zobrazování — závěr

- + Funkční zobrazování; intenzita metabolických procesů
- + Funkce mozku, prokrvení, onkologie
 - Radiační zátěž. Výroba radiofarmak.
 - Anatomie jen částečně
 - Špatné prostorové rozlišení